



U.S. DEPARTMENT OF
ENERGY

Electricity Delivery
& Energy Reliability

NASPI North American
SynchroPhasor Initiative

American Recovery and
Reinvestment Act of 2009

Model Validation Using Synchrophasors

NASPI Technical Workshop
October 22, 2013

NASPI Synchrophasor Technical Report

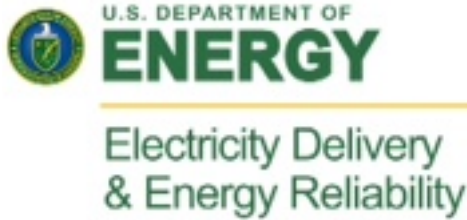

**North American SynchroPhasor Initiative
Technical Report
Model Validation Technical Workshop
October 22, 2013
Technical Summary**

Context

This technical material was developed in October, 2013 by members of the North American SynchroPhasor Initiative, a collaboration between the North American electric industry (utilities, grid operators, vendors and consultants), the North American Electric Reliability Corporation, academics, and the U.S. Department of Energy, to advance and accelerate the development and use of synchrophasor technology for grid reliability and efficiency. The material attached was produced for one of a series of NASPI technical workshops intended to educate and document the stakeholder community on the state of the art for key synchrophasor technology issues.

Synchrophasor technology was developed thanks to early research investments by the U.S. Department of Energy and Bonneville Power Administration in the 1990s. With recognition that synchrophasor technology -- high-speed, wide-area, time-synchronized grid monitoring and sophisticated analysis -- could become a foundational element of grid modernization for transmission system, the Department continued and expanded its investment and industry partnerships in the areas of synchrophasor communications, applications, measurements, and technical interoperability standards.

In 2009, the Department committed a total of \$412 million of funds from the American Recovery & Reinvestment Act of 2009 to twelve Smart Grid Investment Grants and one Smart Grid Demonstration Project that implemented and tested synchrophasor technology using matching private funds. While some of the ARRA funds was spent on other transmission assets, in aggregate over \$328 million of federal and matching private investment was spent on synchrophasor technology and related communications networks.

Additionally, DOE has funded significant technical assistance for NASPI and synchrophasor advancement through the National Laboratories and the National Institute for Standards & Technology.

NASPI serves as a forum for information-sharing and problem-solving among the synchrophasor projects and stakeholders. Much of the work and insights reflected in this technical workshop was enabled by individuals and companies funded by DOE's on-going research and development projects and the ARRA investments. Thus it is appropriate to recognize the insights and work product documented in this workshop and technical report as one of many consequences and work products resulting from the federal Smart Grid investments. Therefore, the Department joins NASPI in re-releasing this material to the smart grid community to document additional impacts and value realized from the federal Smart Grid investments in synchrophasor technology.

The Purpose of the Model Validation Workshop

Model validation is an early success in the use of synchrophasor data to improve power system reliability. The power system is designed and operated based on mathematical models describing the expected behavior of power plants, grid elements and the grid as a whole. But if a generator doesn't act in the way its model predicts, but the grid is operated according to the model's predictions, then erroneous assumptions about how grid assets will behave can lead to severe disturbances and costly equipment damage. Inaccurate models have contributed to a number of recent North American power outages.

Because phasor measurement units collect high-speed, time-synchronized data about grid conditions, PMU data collected about a power plant's behavior during a grid disturbance can be used to improve the model of that generator. This workshop featured technical experts explaining the value of PMU data-based model valuation and walking through several examples of the model validation process and results for a variety of power plants. The workshop closed with discussion of the distinction between generator models and power system models.

The material that follows includes a summary of the model validation workshop, the workshop agenda, and all of the presentations made at the workshop.



NASPI MODEL VALIDATION TECHNICAL WORKSHOP
October 22, 2013
WORKSHOP SUMMARY

With increased deployment of phasor measurement units (PMUs) across North America's bulk power system, utilities and grid operators are gaining new insights into grid and asset behavior. This change results from PMU collection of high-speed, time-synchronized data about grid conditions (voltage, current, frequency, and phase angles). Model validation has been recently recognized as a highly successful use for synchrophasor data, because model testing and improvement using actual grid performance information is more accurate and often economical than traditional off-line asset testing.

In October 2013, NASPI held a technical workshop to review the state of the art in model validation, inviting leading practitioners and researchers to explain the model validation process and share case studies in its use. These notes summarize those presentations, which are attached to this summary for the reader's review. The technical workshop was webcast and the last three hours of the webcast have been archived [here](#) as a video attachment on the Model Validation Workshop page.

Why do modeling?

Tom Burgess (NERC) opened the workshop. He explained that the power system is designed and operated based on mathematical models that tell us the expected behavior of power plants, grid elements, and the grid as a whole. When a generator or the system does not act in the way that its model predicts, the mismatch between reality and model-based expectations can cause severe disturbances and costly equipment damage. Inaccurate models have contributed to a number of recent North American power outages, including the 1996 WSCC outage (illustration below, Figure 1).

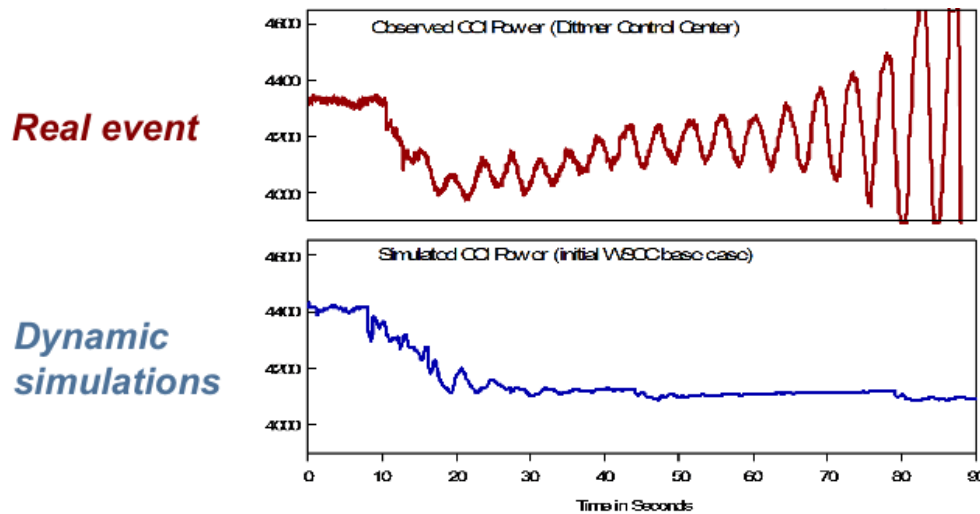

Figure 1 -- WSCC August 1996 Outage -- actual event (top) and the simulation that showed what planners expected would happen. (Source: BPA)

The time granularity and geographic specificity of synchrophasor data make it perfect for model validation, allowing the analyst to benchmark and improve models against actual system performance rather than hypothesized behavior. And better models improve system security and asset utilization.

Bob Cummings (NERC) said that bad models lead to bad decisions in planning and operations, and can lead us to operate the system -- unintentionally -- in an insecure state. Unmodeled and therefore unanticipated generation behavior causes many grid disturbances.

NERC has begun an initiative to improve and validate powerflow and dynamics models, benchmarking them against actual system performance as measured by PMUs. NERC is also working with industry to study the interaction of system protection and turbine controls -- again, using actual system performance, measured by PMUs, for better understanding. Because WECC has already made much progress in model validation, much of this new work is focused in the electrically complex Eastern Interconnection, where there is much to learn about governor and exciter models, load behavior, frequency response, and inter-area oscillations. Another Eastern Interconnection priority should be to improve the compatibility and ease of data exchange between regional system models and asset models.

Vickie vanZandt (WECC) reports that we need better models because the current electrical system is very complex and requires good models and simulations in order to design appropriate operating limits and protection systems. Again, bad models foster inappropriate system designs (Figure 2).

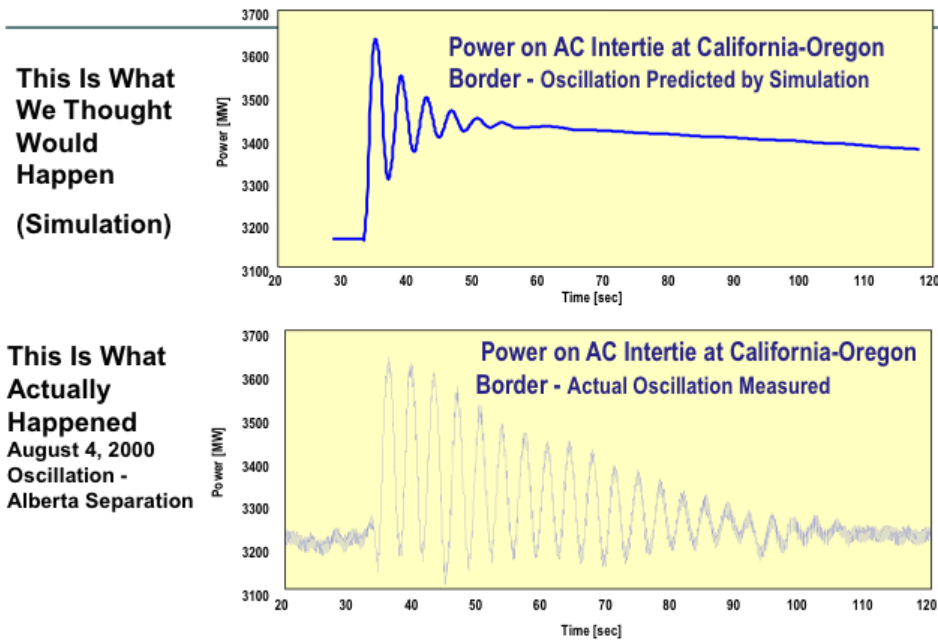
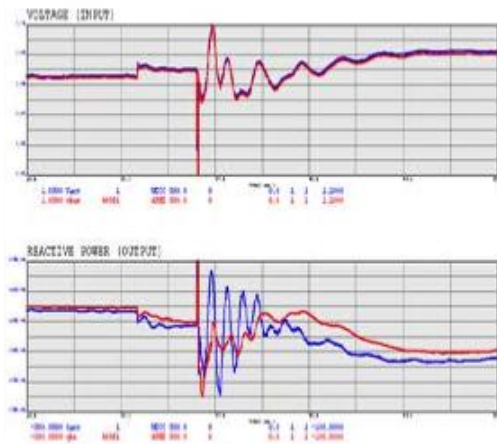

Figure 2 -- August 4, 2000 Oscillation that led to the separation of Alberta from the rest of the Western grid -- the simulation led planners to expect that under these conditions the oscillation would damp out, when in fact the oscillations lasted much longer with violent result. (Source: WECC)

VanZandt also illustrated the application of synchrophasors for power plant model calibration (Figure 3).

Before Calibration

Blue = Actual Response
Red = Simulated Response



After Calibration

Blue = Actual Response
Red = Simulated Response

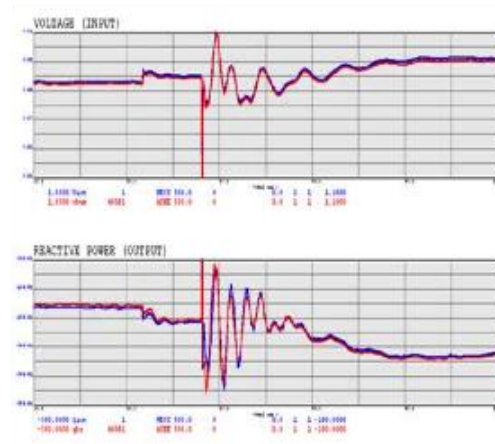

Figure 3 -- Comparison of model fidelity and actual generator behavior for an 1,100 MW nuclear plant before and after PMU data-based model calibration
(Source: BPA)

Generator models

Dmitry Kosterev (BPA) reiterated that accurate power system models are required for reliable, economic grid operation. NERC's MOD standards¹, developed after the 2003 Northeast blackout, require formal model verification. An accurate generator model requires both the correct model structure and an accurate set of data. Transmission planners can use PMU recordings of system disturbances for independent verification of models and dynamic performance.

Following the 1996 outages, WECC required that generator owners test their equipment for the purpose of model verification. WECC differentiates between (i) baseline model development and (ii) periodic model verification. For baseline model development, stage testing is often required. Even then, as BPA experience has shown, staged tests can produce inconsistent results, and PMU disturbance data is useful in supplementing the model development. For periodic model verification, BPA finds PMU data to be a cost-effective way to perform model verification, because the data are collected with the generating unit in normal operation and do not affect its power production.² In addition,

¹ All of the current NERC reliability standards, including the MOD (modeling) standards can be found at <http://www.nerc.com/pa/Stand/Reliability%20Standards%20Complete%20Set/RSCCompleteSet.pdf>.

² Traditional generator testing has required the generator to be taken off-line, cutting power production and revenues, and producing test results that can be inconsistent.

model verification using PMU data can be done more frequently (up to 10 times per year compared to once every 10 years under the current NERC Standards), maintaining high overall system reliability.

WECC testing has revealed that plants with legacy analog controls have the most errors and their settings and performance tend to change over time. In contrast, plants with modern digital systems enter service with good models that stay accurate over time (because the plants' behavior changes less over time). Common sources of generator model inaccuracy can include erroneous representations of power system stabilizers, turbine control operations, governor models, and generator inertia. In some cases the errors are due to deficiencies in the model's structure (i.e., the characteristics of generator behavior and the relationships between its elements have not been accurately represented), and in other cases the model has been mis-calibrated (i.e., while the structural elements are correct, some of the settings are inaccurate).

BPA has been using PMU data recordings of generator performance in response to grid disturbances to validate dynamic models of power plant data. Insights from these events complement baseline model development, and plant performance through multiple grid events yield richer data that produces more accurate models. BPA has developed software to automate model testing and validation using synchrophasor data.

Once a good power plant model is established, PMU recordings of system disturbances can be used for "clinical" assessment of power plant performance and detection of control failures, such as a failure of a power system stabilizer at a large hydropower generator in Pacific Northwest (Figure 4). BPA's goal is to get a "performance report" on its entire generating fleet within minutes of a system disturbance event.

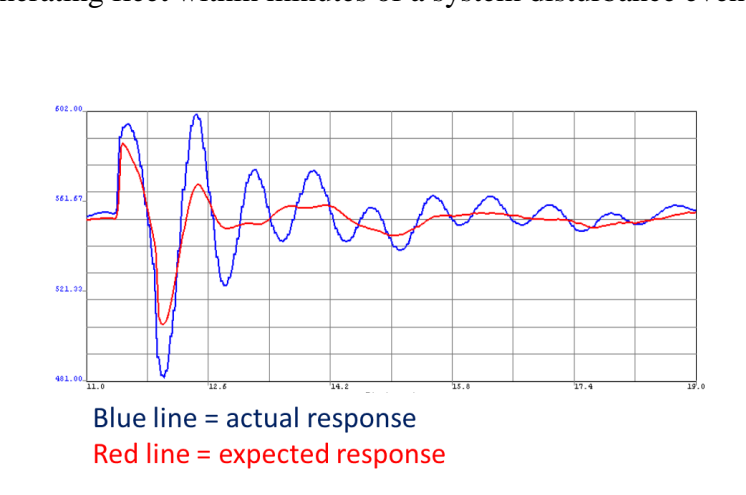

Figure 4: BPA detected power system stabilizer failure at a large hydropower generator using PMU recordings (Source: BPA)

Bob Zavadil (Enernex) has been leading work for the Utility Variable Integration Group and the National Renewable Energy Laboratory to validate models of wind generators

and photovoltaic plants; with the rapid growth in renewable generation capacity across the continent, it is crucial that grid designers and operators can understand and predict how these plants contribute to and respond to potential grid problems (particularly with respect to local voltage). Oklahoma Gas & Electric has a significant amount of PMU-recorded data on wind plant performance that is being used for this effort.

To validate a wind plant model, Zavadil starts with detailed information about the power plant, and a generic model for the wind turbine. He aggregates the wind turbine model to approximate the magnitude of the plant as a whole, and uses parameter sensitivity analysis to iteratively adjust the wind turbine models until their modeled behavior collectively resembles like the actual measured events.

The participation of plant owners and transmission operators is critical for model validation, to get detailed information about both the plant and the grid. Zavadil points out that although disturbance data is essential for model validation, there are not a lot of events on the grid, so appropriate data for validation may be long in coming. For this and other reasons, UVIG has begun a renewable plant model validation collaborative to share model validation information and resources.

Pouyan Pourbeik (EPRI) and George Stefopoulos (NYPA) used generic models developed by EPRI and NYPA to improve dynamic models for NYPA's static VAR systems (the Marcy convertible static compensator and its SVC). Beginning with the generic SVC models and PMU data from disturbance events, they calculated from the PMU data the injected reactive current and reactive power of the SVC and chose the device model accordingly. NYPA has also automated its model optimization process with the Static VAR System Model Validation tool.

Xiaochuan Luo (ISO-NE) asserted that phasor data and on-line transient stability assessment are the foundations for dynamic model validation. ISO-NE has used PMU data to validate nuclear plant and HVDC models. Figure 5 shows the ISO-NE HVDC model performance before and after validation, relative to actual PMU-recorded performance during a single-phase ground fault. Similarly, they validated the Millstone nuclear unit model using PMU data for a Phase B to ground fault that occurred 16 miles away from the power plant.

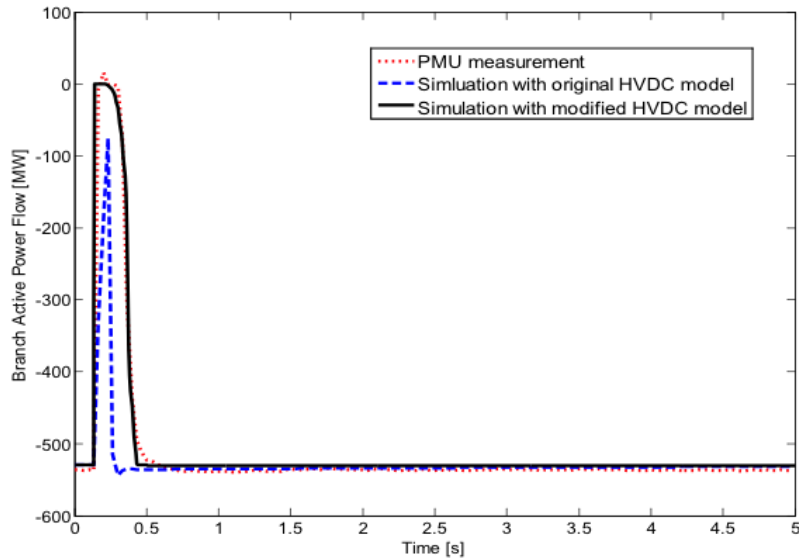

Figure 5 -- ISO-NE validation of HVDC model (Source: ISO-NE)

ISO-NE has also automated its model validation process using actual system event data, and is now moving on to validate other models for generators, HVDCs, loads, and SVCs.

Bill Blevins (ERCOT) reports that ERCOT is using phasor data for model validation in part because the PMUs record on-line events and activity that may not be observable in off-line field generator testing. The ERCOT process goes beyond model validation, and includes identifying voltage oscillations at the plant (including poorly damped oscillations at low output and undamped oscillations at high output) and doing post-event analysis to recreate the oscillations (through simulations). This allows them to identify the causes and find solutions to mitigate the oscillations.

ERCOT is using this process to comply with NERC's MOD 26 and 27 requirements for generator and exciter model validation, to assure that its dynamic models match actual equipment in the field. ERCOT is tuning its models with parameter estimation and verification. Blevins notes that reduction of its system models to data time-series simplifies the model validation process and facilitates automated model validation.

Bernie LeSieutre (University of Wisconsin) has been working to refine the process of model revalidation or invalidation and calibration using PMU disturbance data. Comparison of the recorded actual event against the model's predicted generator performance allows the analyst to determine whether the model's predictive capability is so far off that it should be fully refuted, restructured, or recalibrated (Figure 6). He showed examples of how to use PMU data to compare against the original model. LeSieutre also showed results of validated models (with model fit improvements) that can predict operational results that match actual historical performance (Figure 7). The model fit process uses sensitivity models to understand model components and hone in

on whether the appropriate improvements might entail structural modification or recalibration to modify the model parameters (Figure 8).

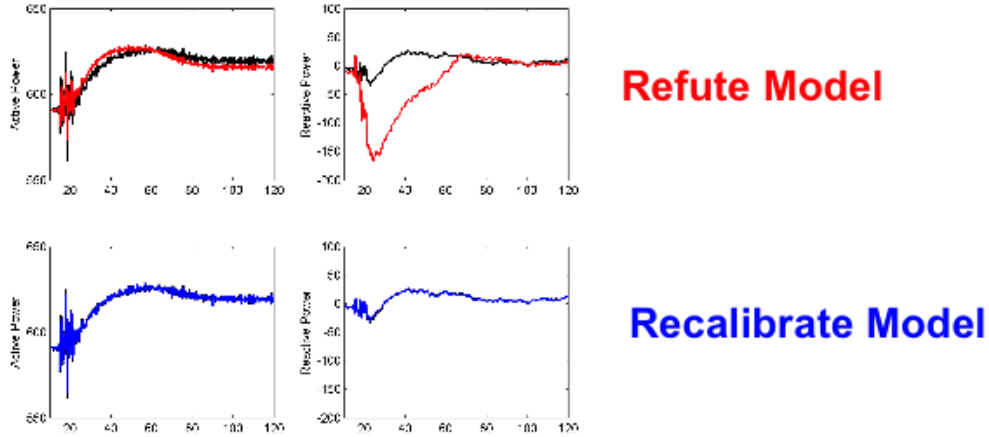

Figure 6 -- Comparing real data against the model -- black lines are original model results, red lines are PMU data, blue lines are recalibrated model results (Source: LeSieutre, University of Wisconsin)

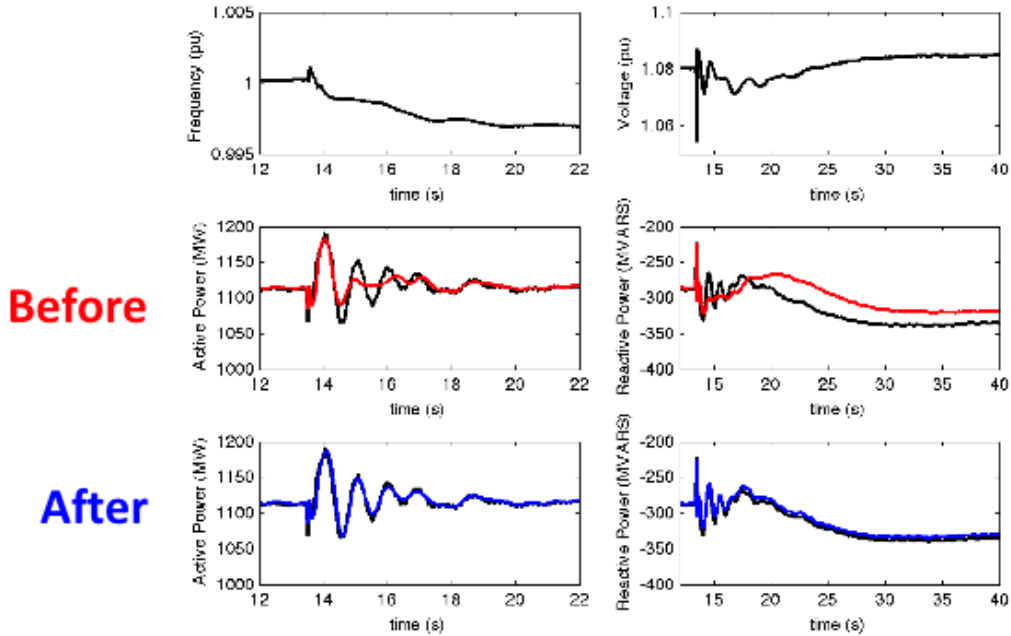

Figure 7 -- Using PMU data to adjust model to the observations -- black lines are original model results, red lines are PMU data, blue lines are recalibrated model results (Source: LeSieutre, University of Wisconsin)

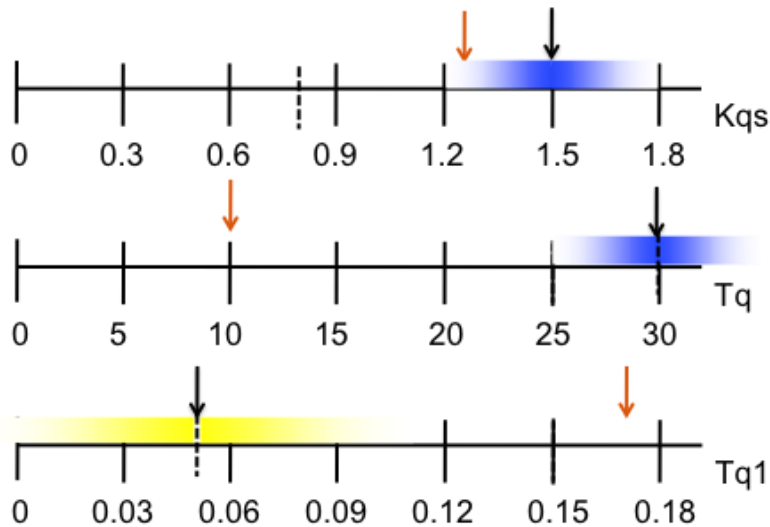

Figure 8 -- Examples of parameter adjustments in model recalibration (Source: LeSieutre, University of Wisconsin)

LeSieutre emphasized that models validated against data from multiple disturbances produce better results. He said that even with an automated model validation processes, engineering judgment is still essential to understand the models and know whether the model needs calibration or structural improvement.

System model validation

Dmitry Kosterev (BPA) explained that while a power plant model looks at only one element on the grid, system models need to accurately represent not only individual grid elements (generators, transformers, SVCs, etc.) and loads, but also how all those elements will interact with each other. During a disturbance, the grid as a whole may act in ways different from just the sum of its parts. System modeling is not yet as far advanced as power plant modeling, in part because it is only recently that system planners have viewed the relevant system scope as being an entire interconnection rather than the footprint of a single transmission owner or reliability coordinator.

Bharat Bhargava, Kevin Chen and Anamitra Pal (all with Electric Power Group) and Juan Castaneda and Farroukh Habibi-Ahsrafi (Southern California Edison) have used data from three major western grid events to validate the dynamic system response simulated by two phasor data applications: RTDMS and PGDA. Using the data from the 2011 Pacific Southwest blackout, the January 2008 HVDC oscillations, and simulations of the Pacific Intertie under stress, the team performed dynamic event simulations using PSLF. They then streamed the data into the RTDMS visualization tool and the PGDA off-line analysis tool. They report that these simulations can be used

effectively to compare and validate models and to feed event replays for operator training.

Dmitry Kosterev (BPA) and his team have been using PMU data on past oscillations and Fault-Induced Delayed Voltage Recovery events to improve the load model in GE's PSLF tool and Siemens' PSS/E. They caution that while we can tune and improve load models, load behavior is so complex that we can't fully predict how load will behave. Additionally, since loads are connected to individual electrical phases on the system, we need to collect and analyze point-on-wave data rather than positive sequence data to perform accurate load analysis. BPA and WECC are working with the DOE CERTS program and SCE to collect such data using distribution-level power quality monitors.

Eric Allen (NERC) warns that without periodic updating and evaluation, models that started out relatively accurate can "drift" from actual system behavior over time through the collective impacts of new load dynamics and generator dynamics. Over time, a few "insignificant" discrepancies in the models of individual grid elements can accumulate and, in aggregate, produce significant errors in system model estimates.

Planners today are increasingly using dynamic disturbance data to test system dynamics models. To do this they develop a powerflow case to represent system conditions preceding the disturbance and perform dynamic simulations with those starting conditions. They then iterate those simulations to adjust them against actual events using parametric analysis and adjustments. The planner's goal is to produce a model with high fidelity relative to actual events.



**NASPI TECHNICAL WORKSHOP
MODEL VALIDATION USING SYNCHROPHASOR DATA**

**TUESDAY, OCTOBER 22, 2013
8:30 am to 12:30 pm**

**Crowne Plaza Chicago O'Hare Hotel
5440 N. River Rd.
Rosemont, Illinois 60018**

O'Hare V Ballroom

This workshop will provide a detailed grounding in the benefits of using synchrophasor data for electric system and power plant model validation and explain the process and steps for doing so. Presenters will address recent requirements and opportunities for model validation, provide an overview of generator and power system models and model validation tools, and explain what synchrophasor data are needed for power plant and system model validation. Several speakers will provide detailed briefings on the process and results of several specific cases where synchrophasor data have been successfully used for power plant model validation, identification of inappropriate asset operations, and dynamic grid models.

If you wish to attend this technical workshop, please register at [model val workshop](#); there is no registration fee.

If you cannot join us in person for this workshop, you can follow the presentations in real time through webinar access -- use → [Join Lync Meeting](#) (<https://lcmeeet.pnnl.gov/teresa.carlon/RYJ8RKQM>). Remote participants will not be able to interact with the presenter. The workshop presentations will be posted on the NASPI website (www.naspi.org) and we will attempt to archive and post the webinar as well.

The Work Group meeting of the North American SynchroPhasor Initiative, which will feature progress reports from the North American synchrophasor project grant recipients, technical sessions and a vendor trade show, will begin on the afternoon of October 22 (following this workshop) and run through noon on October 24 in the Crowne Plaza Chicago O'Hare Hotel. The NASPI Work Group meeting will require separate registration ([WG meeting reg](#)) and a fee of \$350 for late registrants.

NASPI MODEL VALIDATION TECHNICAL WORKSHOP AGENDA

- 8:30 am Intro -- Tom Burgess (NERC)
- 8:40 am Intro to power plant models and grid models -- Bob Cummings (NERC)
- 8:55 am Why use synchrophasor data for model validation -- Vickie vanZandt (WECC)
- 9:05 am Expectations and practicalities for using phasor data -- Dmitry Kosterev (BPA)
- 9:15 am The basics of plant model validation using PMU disturbance data – Dmitry Kosterev (BPA) – Value of using PMUs for model validation and detection of control abnormalities; data required for model validation and calibration; steps required to set up model validation and generator performance monitoring process by Transmission Planner and Generator Owner; WECC and BPA case studies.
- 10:00 am Break
- 10:15 am Case study 1 -- Wind power plant model validation -- Bob Zavadil (for UVIG, using OG&E wind plant data) -- current model validation efforts (scope, what kinds of wind plants and turbines being studied), how applicable plant-specific data and model results are to other wind plants, why it's needed, what data they're using, how it's going, when it'll be done, what's next.
- 10:35 am Case study 2 -- NYPA validation of dynamic VAR controllers (STATCOM and SVC) -- George Stefopoulos (NYPA) & Pouyan Pourbeik (EPRI) (invited)
- 10:50 am Case study 3 -- ISO-NE validation of nuclear plant unit models -- Xiaochuan Luo (ISO-NE)
- 11:05 am Case study 4 -- ERCOT using phasor data to find inaccuracies in generator models -- Bill Blevins (ERCOT)
- 11:20 am Q&A part 1
- 11:30 am Case study 5 – using phasor data for power plant model calibration and PSS failure detection -- Bernie Lesieutre (University of Wisconsin)

- 11:45 am Case study 6 -- using phasor data and simulations in the RTDMS and PGDA programs to validate system response and dynamic models -- Bharat Bhargava (EPG)
- 12:00 pm Power system dynamic model validation -- Eric Allen (NERC) and Dmitry Kosterev (BPA) -- what model used, why it needs validation, what it takes to develop a validation base case, what synchrophasor data being used, what's the process for doing this, how long will it take to get a model you're happy with, how much of the calibration process requires getting the underlying grid components modeled accurately rather than working on the synergistic results?
- 12:15 pm Q&A part 2
- 12:30 pm Adjourn

The Importance of Modeling

Thomas Burgess

Vice President and Director, Reliability Assessment and Performance
Analysis

NASPI Model Validation Workshop

October 22, 2013

RELIABILITY | ACCOUNTABILITY



- Predict system behavior and the interaction of components
- Provide heightened view of system security
- Enhance situational awareness
- Potentially increase asset utilization
- Flexibility to reliably integrate resources and loads as technology and characteristics evolve

Maximize reliability performance and security

Real event

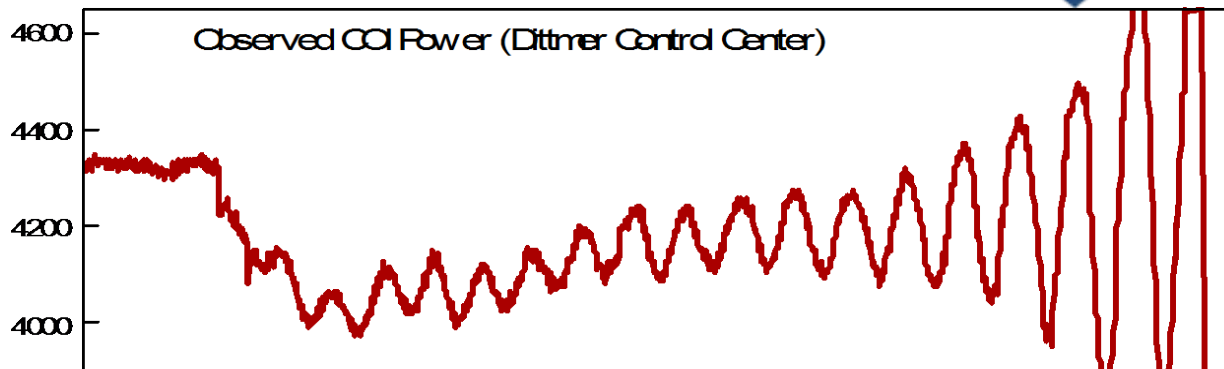

Dynamic simulations

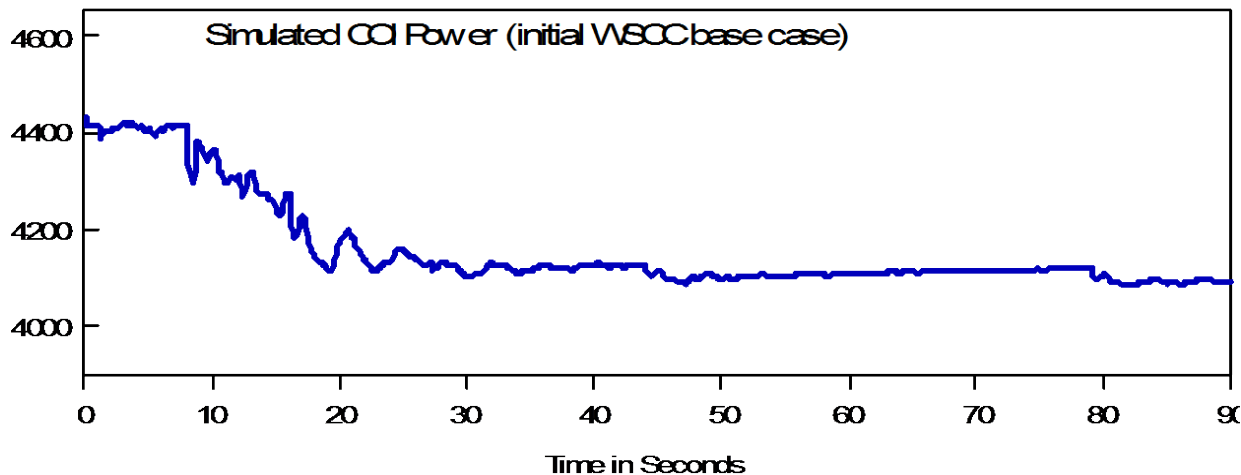

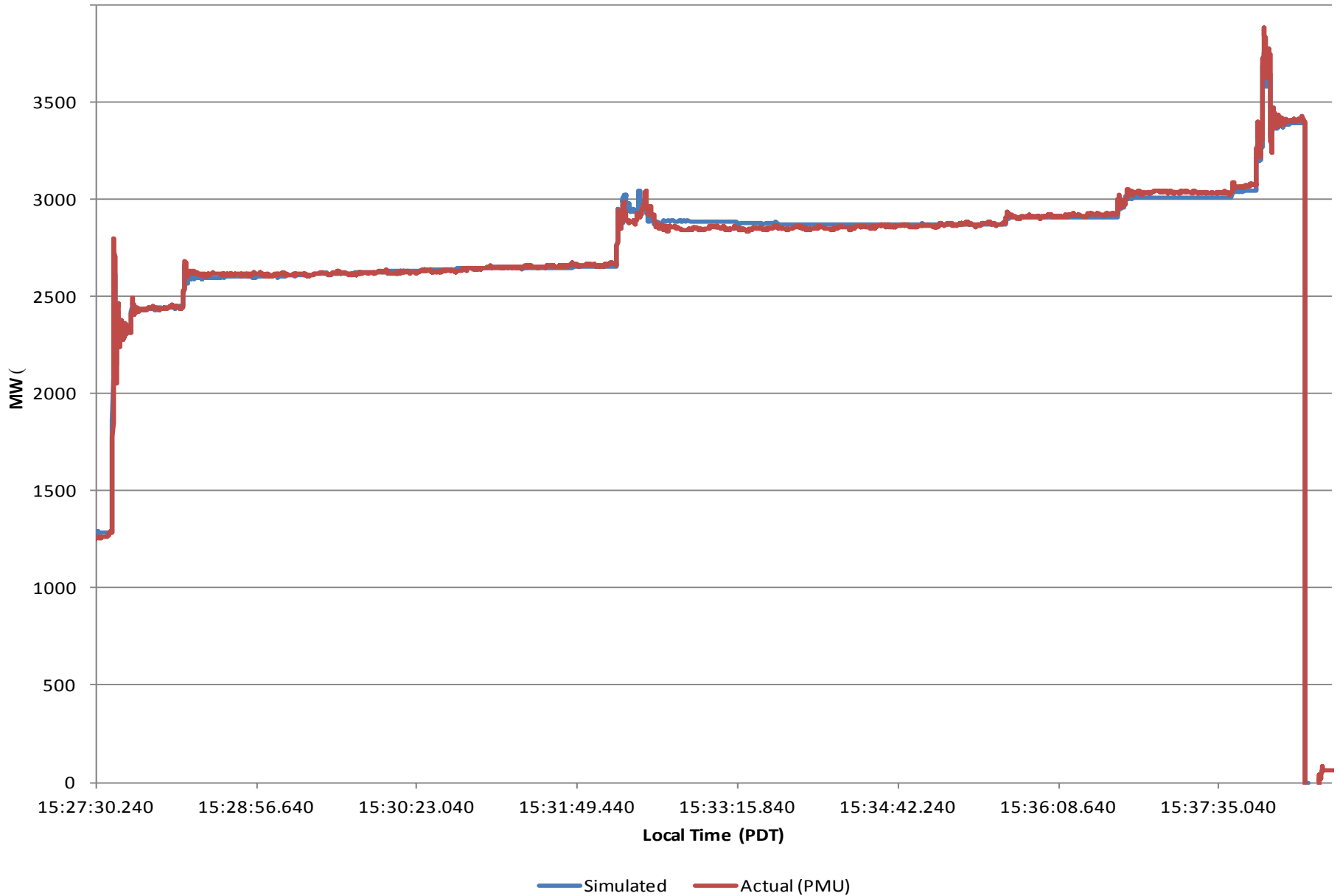

1. Generator Dynamics
2. *Load Behavior
3. *Frequency Response
4. *Inter-Area Oscillations
5. *Equipment Modeling
6. *Special Protection Systems/Remedial Action Schemes
7. *Protection Systems
8. *Turbine and Boiler Controls

Components of a Broad Modeling Initiative Design)

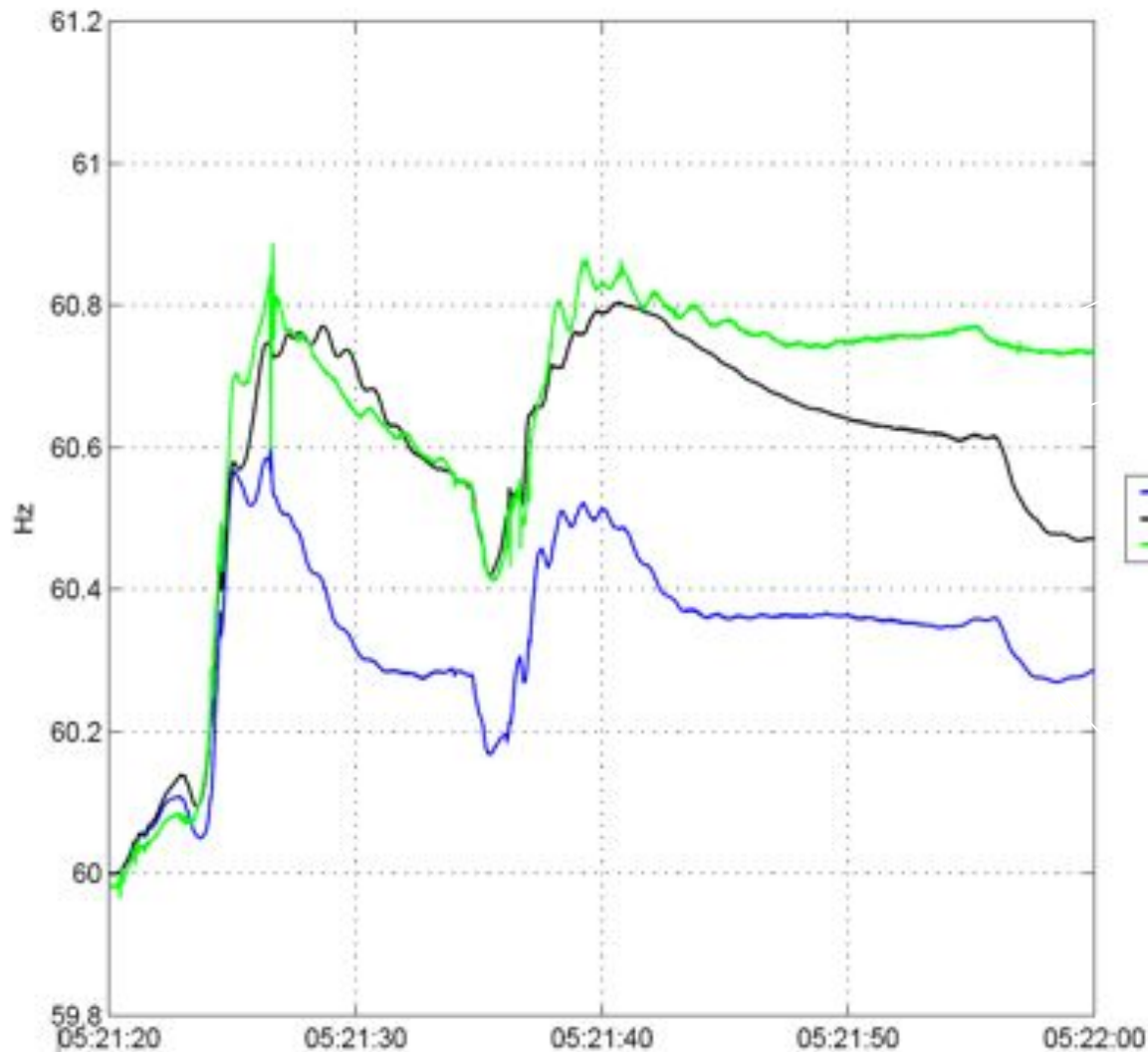

Actual

Models Adjusted

Database Models

- Validation of system behavior and the interaction of components
- High granularity data/insights to heighten system security
- Potentially increase asset utilization
- Effectively integrate resources and composite loads - technology and characteristics evolve)

Maximize reliability performance and security



Questions?

2003 Blackout Recommendations NERC 14 and US-Canada 24:

“The regional reliability councils shall, within one year, establish and begin implementing criteria and procedures for validating data used in power flow models and dynamic simulations by benchmarking model data with actual system performance. Validated modeling data shall be exchanged on an interregional basis as needed for reliable system planning and operation.”

Modeling Improvements Initiative

- Improved and validated powerflow and dynamics models)
 - Benchmarking against actual system performance
- Library of standardized component models for generators and other electrical equipment
- Composite load modeling
- Move toward node-breaker modeling
- Tie to protection setting databases
- Interaction of System Protection and Turbine Controls
- Modeling Guideline – industry technical reference

Operational Modeling and Model Inputs

Robert W. Cummings

Director, Reliability Initiatives and System Analysis

NASPI Model Validation Workshop

July 11, 2013

RELIABILITY | ACCOUNTABILITY



- If something is not modeled, how can you predict system behavior or the interaction of components?
- Bad modeling can give a false sense of security
- Bad Modeling → Bad Decisions
 - Planning – wasted money
 - Operations – unknowingly operating in insecure states

Real event

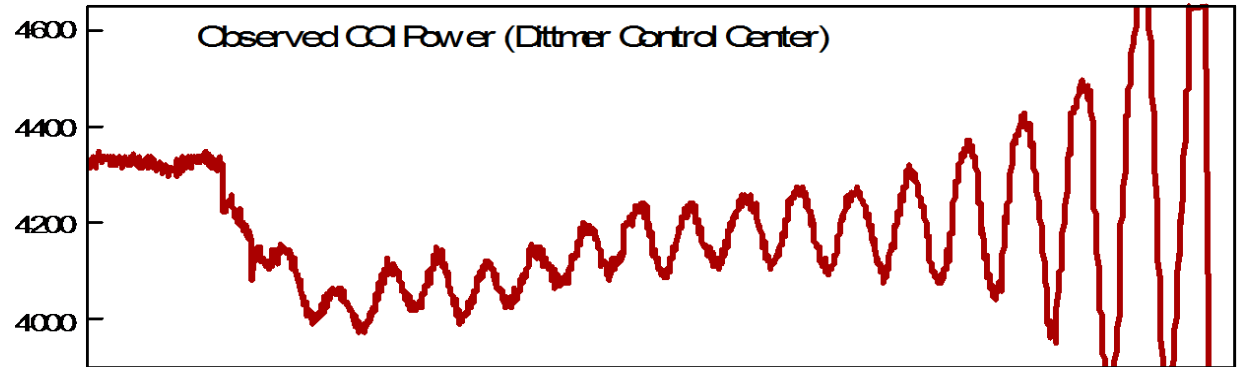

Dynamic simulations

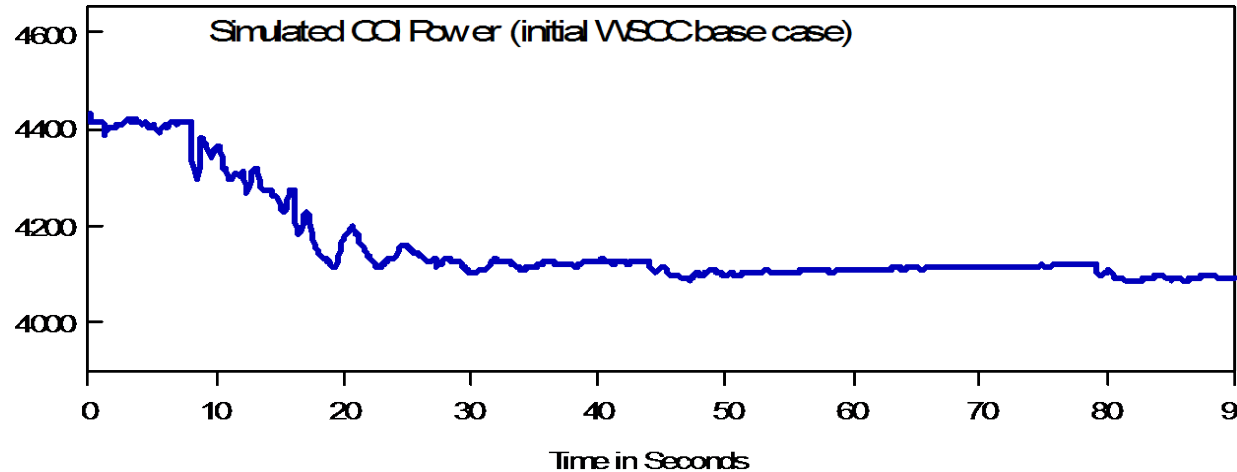

No confidence in dynamic database

- Aggressive testing of generating units
 - 80% of units directly tested
- Validation by Observation adopted
- System probing testing
 - Pacific DC Tie (PDCI) signal injection (ongoing process)
 - Chief Joseph Braking Resistor (1,400 MW) insertion
- Validation by system disturbance PMU recordings
 - Ongoing for significant system events
- Identified 12 discreet inter-area oscillatory modes
 - Identified mode shapes and participating generators
 - Tuned generator controls and Power System Stabilizers

WECC Confidence today

- *grid frequency*

Malin Frequency, June 14 2004 West Wing event

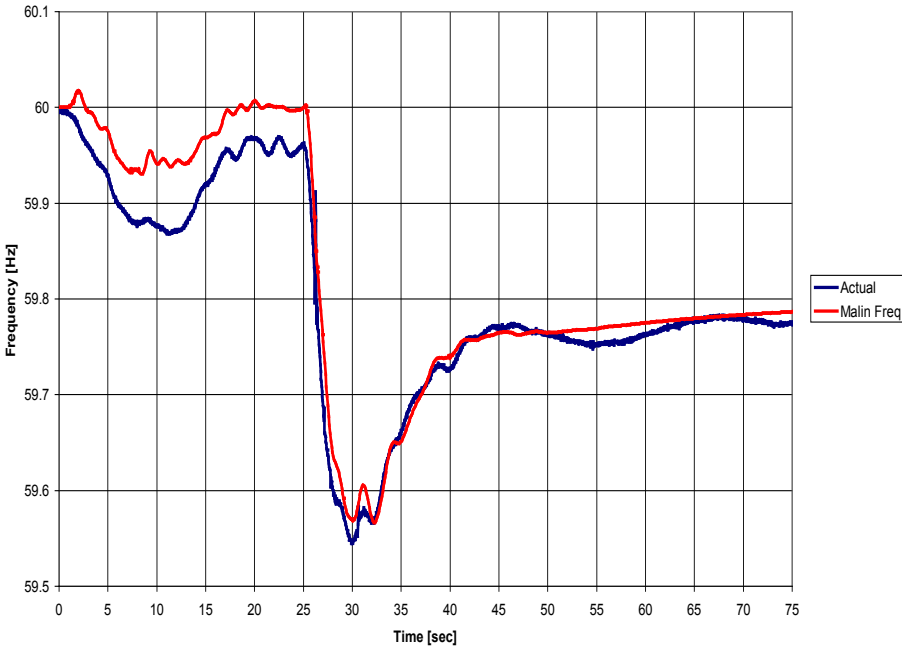

System simulations of June 14, 2004

- *COI power*

COI Power, June 14 2004 West Wing Disturbance

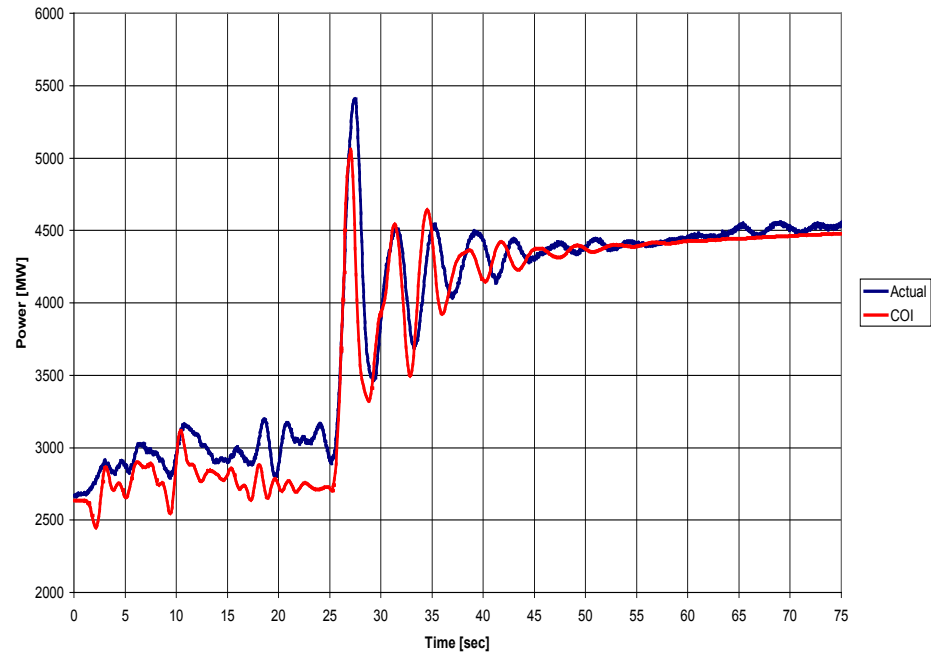

 *Real event*

 *Simulations*

*Highlighted in December 2011 FERC report
“...simulation predicted significantly greater frequency response than was, in fact, recorded by monitoring equipment.”*

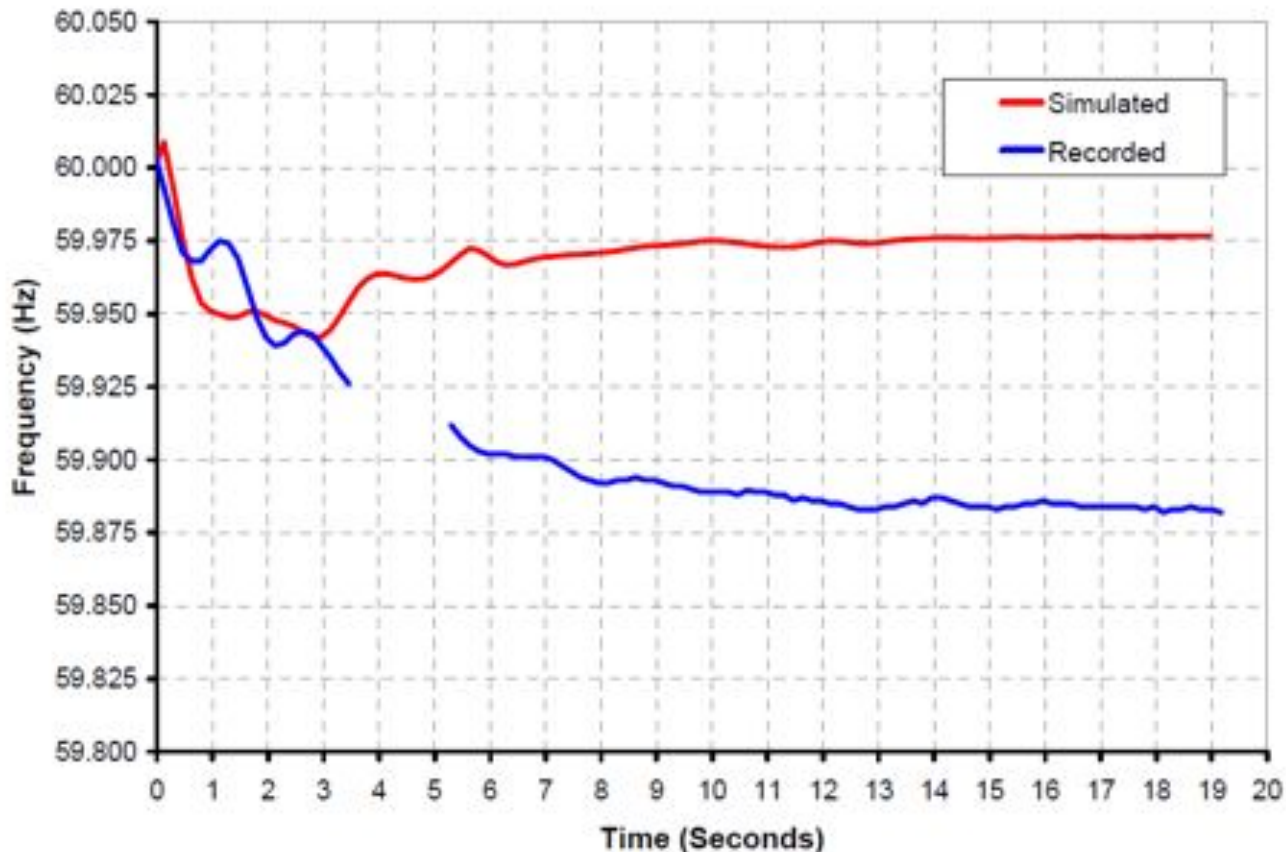

MRO Disturbance Sept. 18, 2007

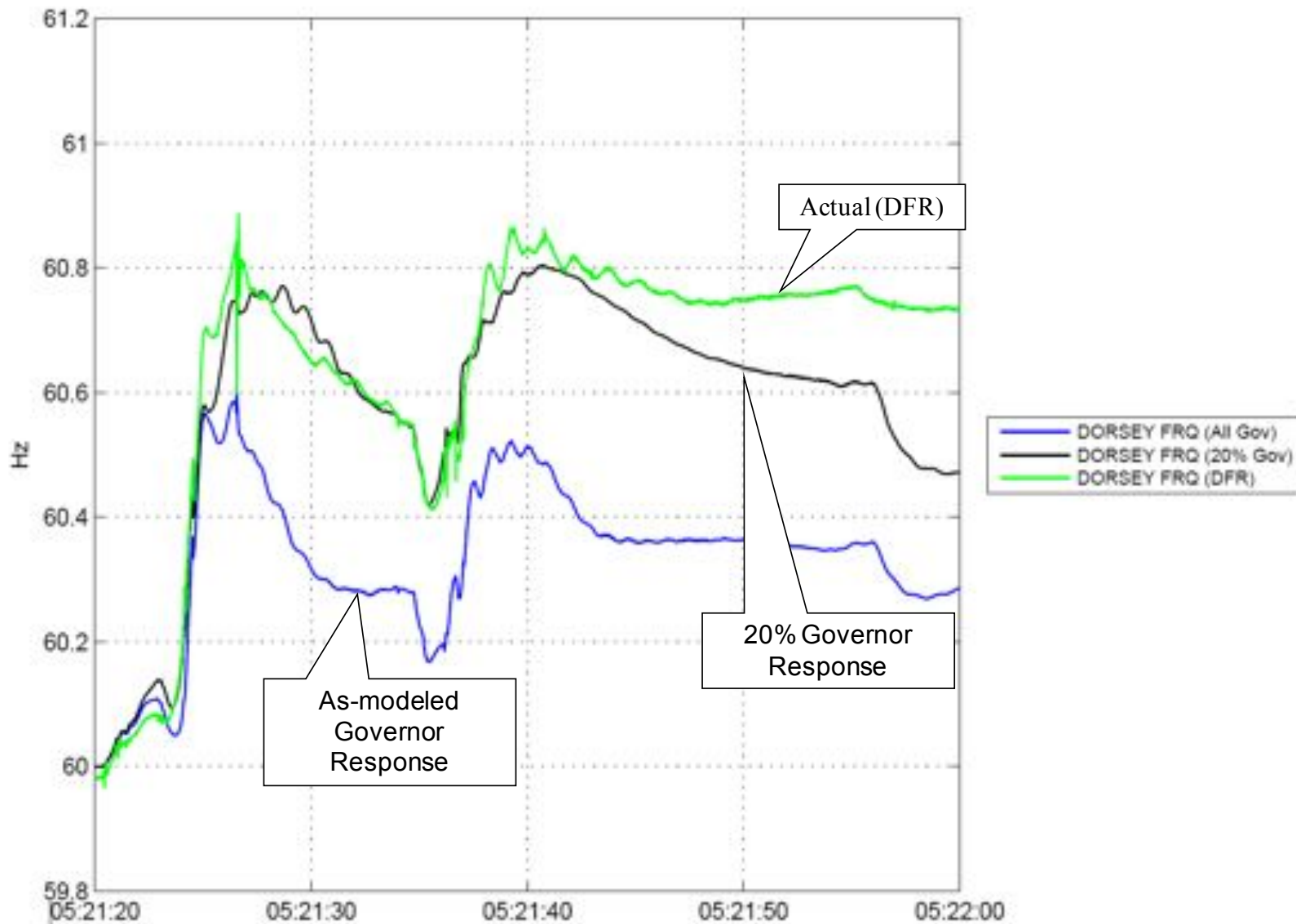

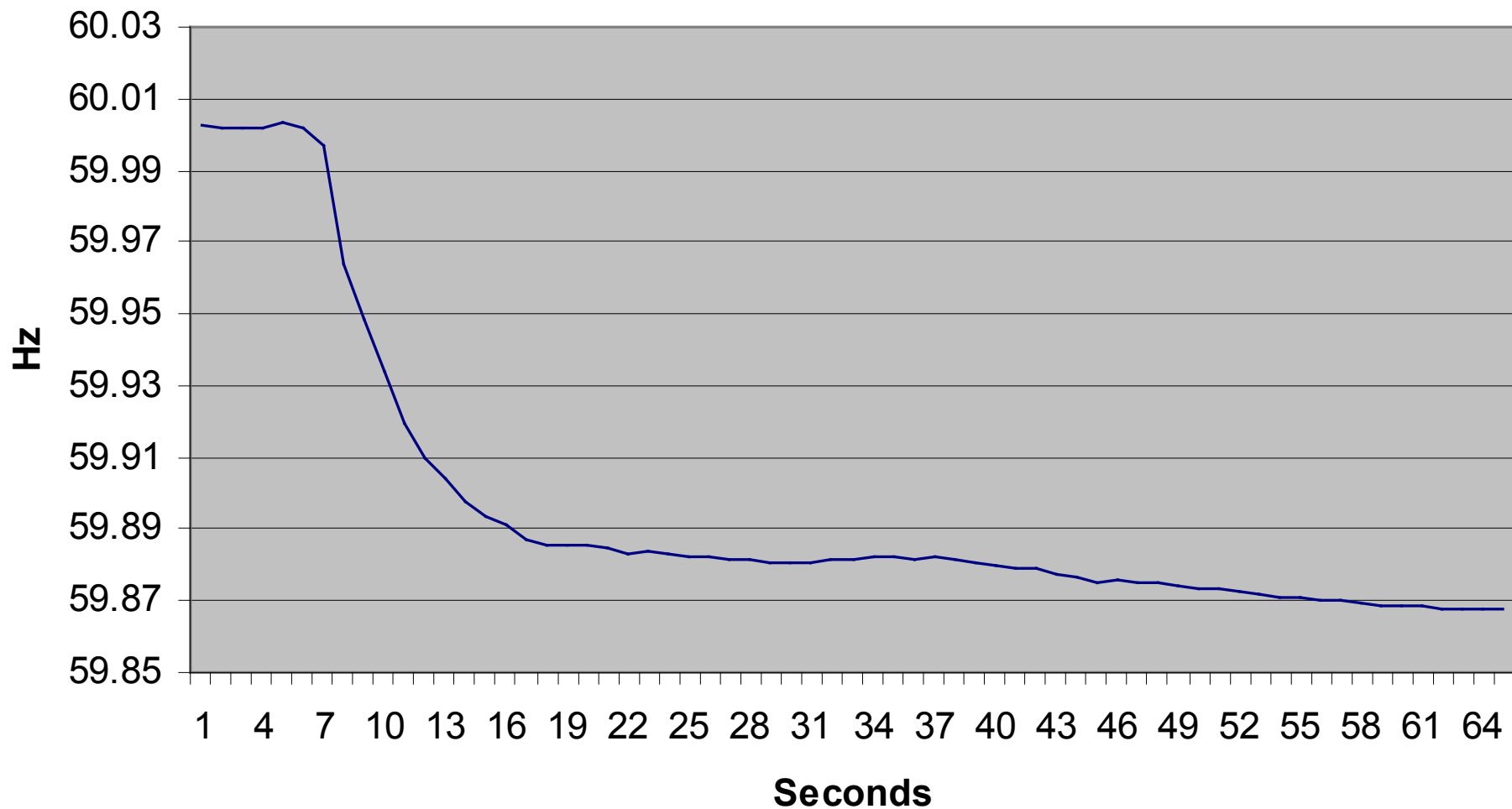

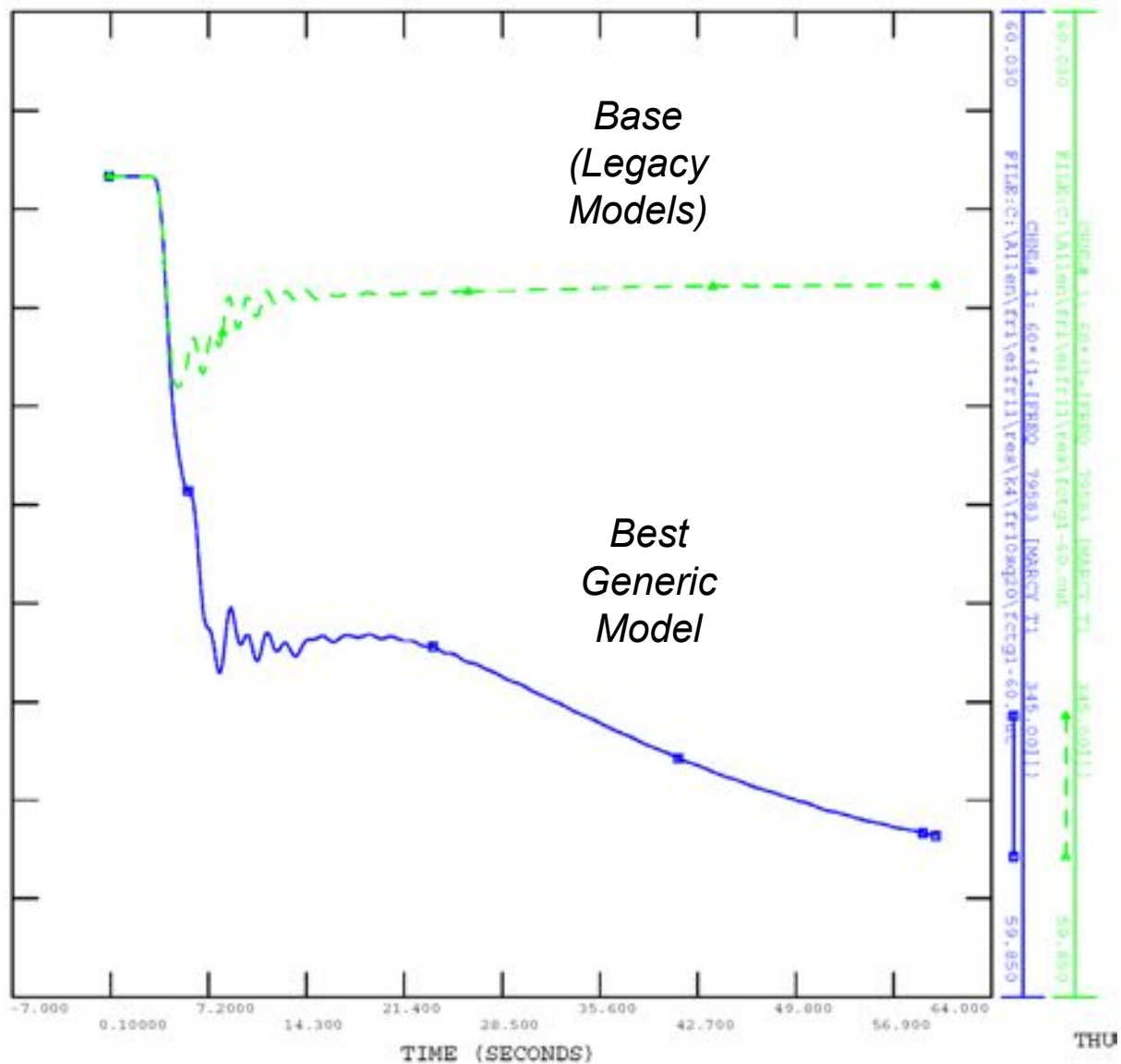

Shakespearean generation

- How can I trip thee, let me count the ways

In 133 system disturbances examined:

- Unexpected Gen. Turbine Control Action (35 times) *
- Voltage sensitivity of gen. aux. power systems (13 generators tripped)

Newton Unit Response

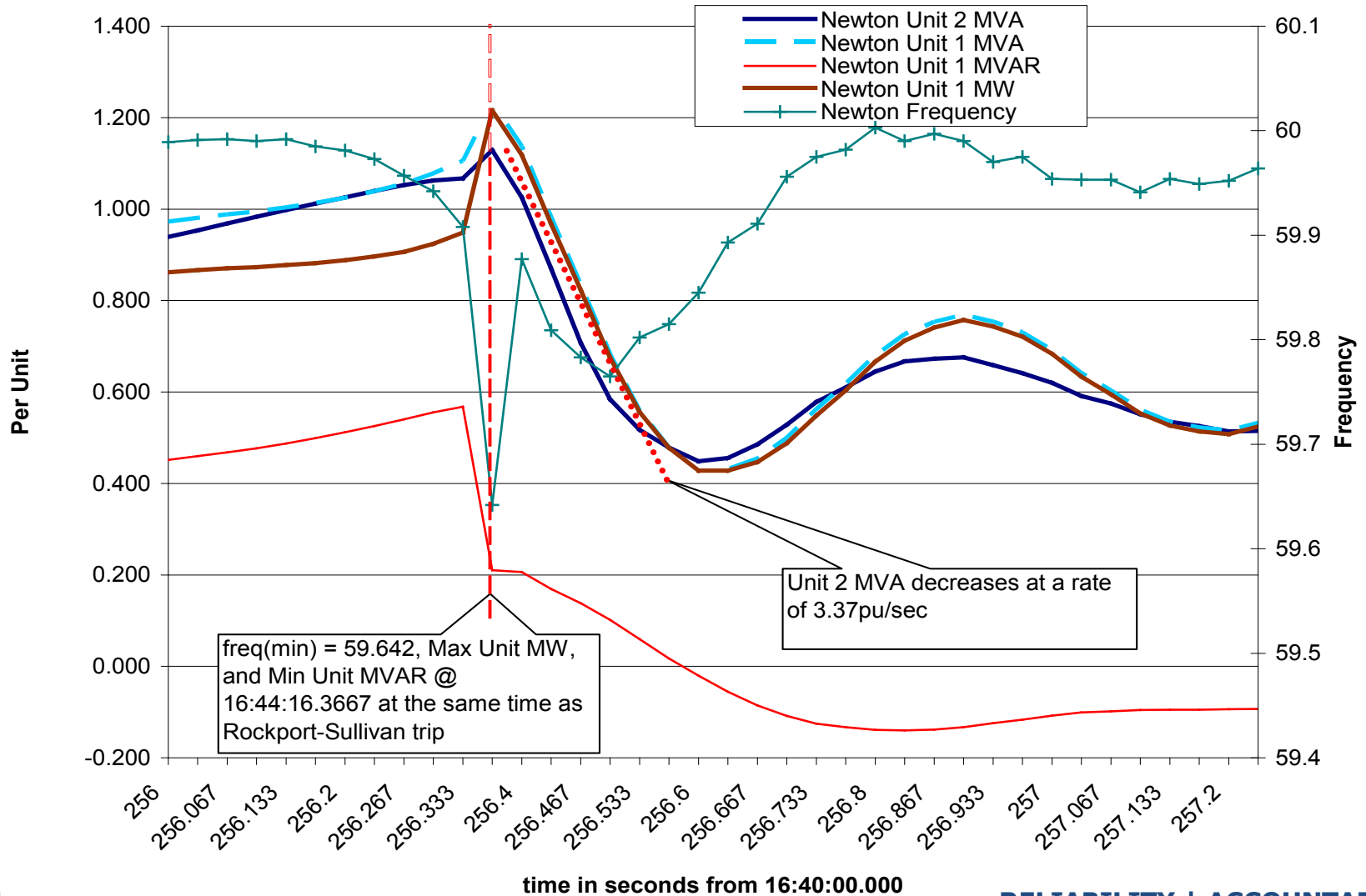

- Improved and validated powerflow and dynamics models
 - Benchmarking against actual system performance)
- Library of standardized component models for)
generators and other electrical equipment
- Composite load modeling
- Move toward node-breaker modeling
- Tie to protection setting databases
- Interaction of System Protection and Turbine Controls
- Modeling Guideline – industry technical reference

1. Generator Dynamics – Eastern Interconnection governor and exciter models are suspect
2. Load Behavior – load composition changing
Use of composite load models necessary
 - More air conditioning load
 - CFL and LED lighting – not like incandescent
 - Variable speed drives
3. Frequency Response – EI dynamics models not capable of simulating primary frequency response

4. Inter-Area Oscillations – EI models not capable of predicting
5. Equipment Modeling – lack of standardized system component models
 - Creating standardized component model library
6. Modeling Errors – data errors, wrong component models
7. Modeling Consistency – varying understanding of models and parameters

8. Model Compatibility – data exchange problems between platforms and programs
9. Approaches to Modeling – operational node-breaker models / Planning bus-line models
10. Special Protection Systems/Remedial Action Schemes – must model to predict interaction
11. Protection Systems – better modeling of protection systems needed
12. Turbine and Boiler Controls – research starting on what should be modeled



Questions?



The Reasons We Need Better Models

Vickie VanZandt, Program Manager
Western Interconnection Synchrophasor Program

Model Validation Workshop

October 22, 2013

Premise – This Isn't Your Mother's Power System Anymore

- The Good Ol' Days:
 - Central plant
 - Stable, predictable commercial arrangements that changed only seasonally
 - Generation with lots of mass and therefore inertia
 - Voltage dependent load that gave you a break if the power system was in trouble
 - Pretty good conditions for system operators

Premise – This Isn't Your Mother's Power System Anymore

- The Complex New Days:
 - Smaller, more distributed generation for which the grid was not designed
 - Many more transactions that change in increments of 5-10 minutes
 - The generation fleet's characteristics have changed – a greater percentage of intermittent, low mass machines – less inertial response to help arrest frequency decline
 - Finally, the load has changed – less industrial, voltage dependent load, and more computer and air conditioning service

So What Does That Mean?

- A grid that is more complex and harder to operate...and demands better modeling.
- No matter how carefully operators, operating engineers, and planning engineers study the system....if the models aren't right....,
-the results they get and the limits they set aren't right either.

So What Does That Mean?

- Of the three components,
 - Transmission
 - Generation
 - Loads
- Transmission is pretty good (status of MODs notwithstanding)
- Generation is improving, but more to go
- Loads need the most work

So What Does That Mean?

- SCADA can't help much with this effort
- More frequent and time-synchronized measurements are necessary to get this model improvement done
- We happen to have some of those coming in.....

Generator Model Validation

(for 1100MW Nuclear Plant)

Before Calibration

Blue = Actual Response
Red = Simulated Response

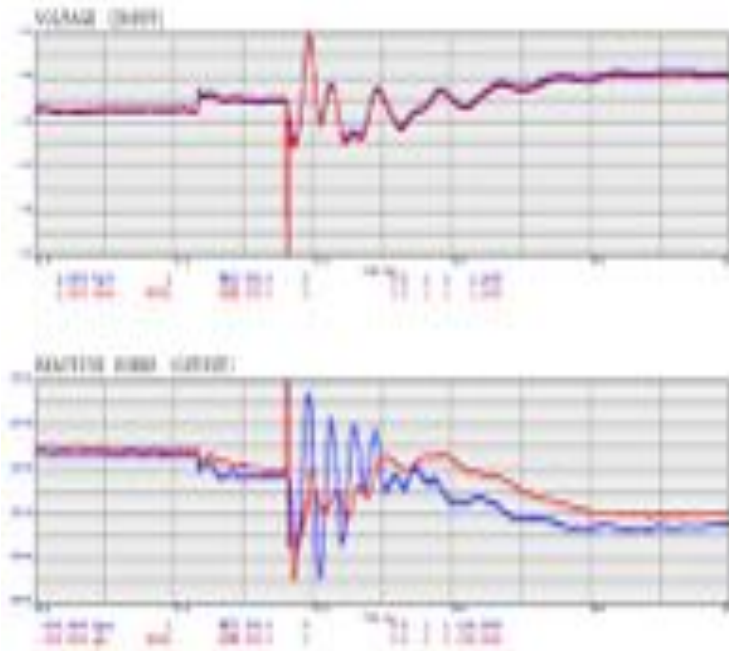

After Calibration

Blue = Actual Response
Red = Simulated Response

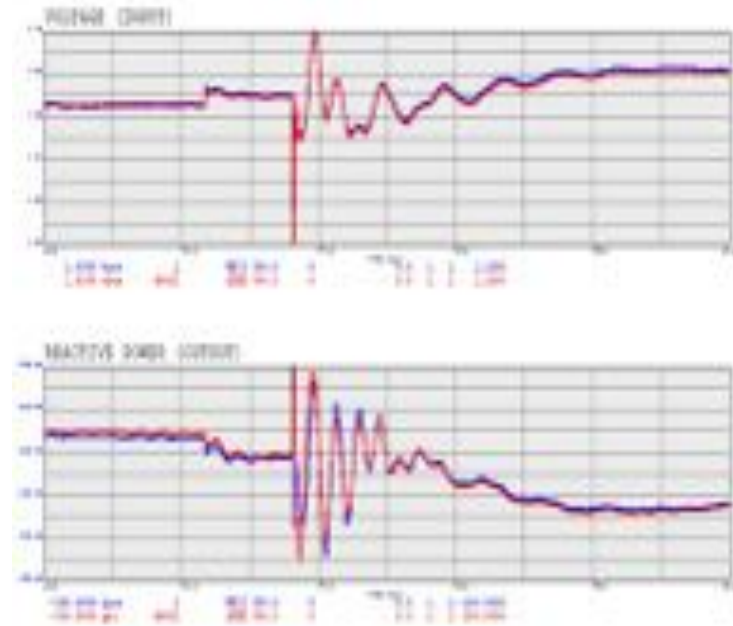

Generator Model Validation (for 1100MW Nuclear Plant)

Before Calibration

Blue = Actual Response
Red = Simulated Response

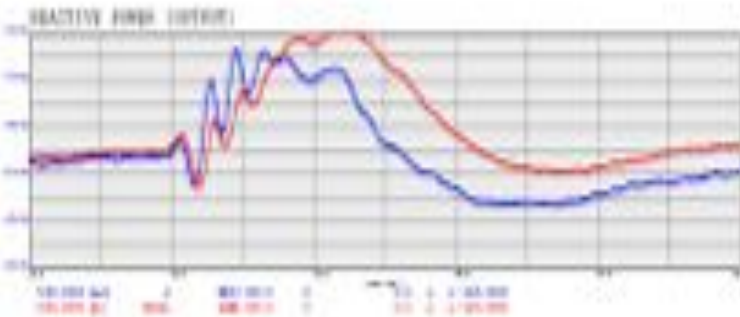
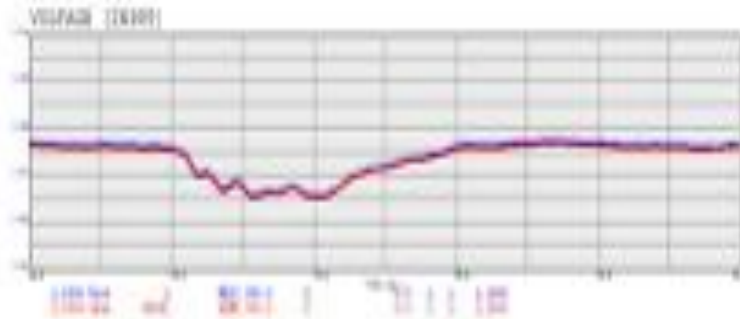

After Calibration

Blue = Actual Response
Red = Simulated Response

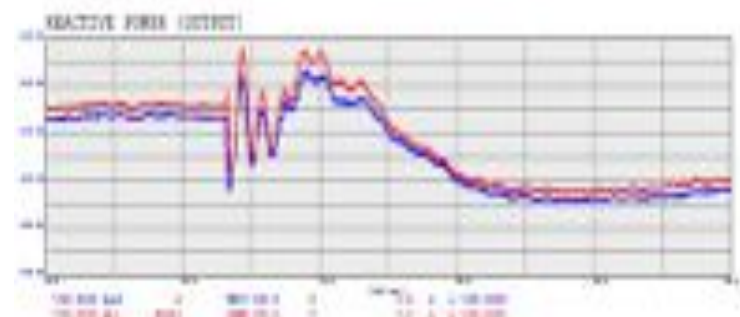
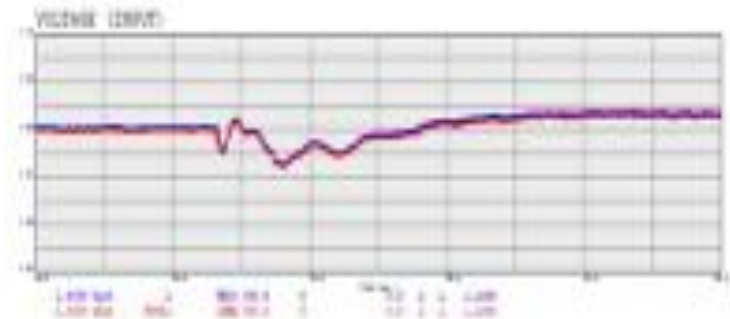

Yikes

**This Is What
We Thought
Would
Happen
(Simulation)**

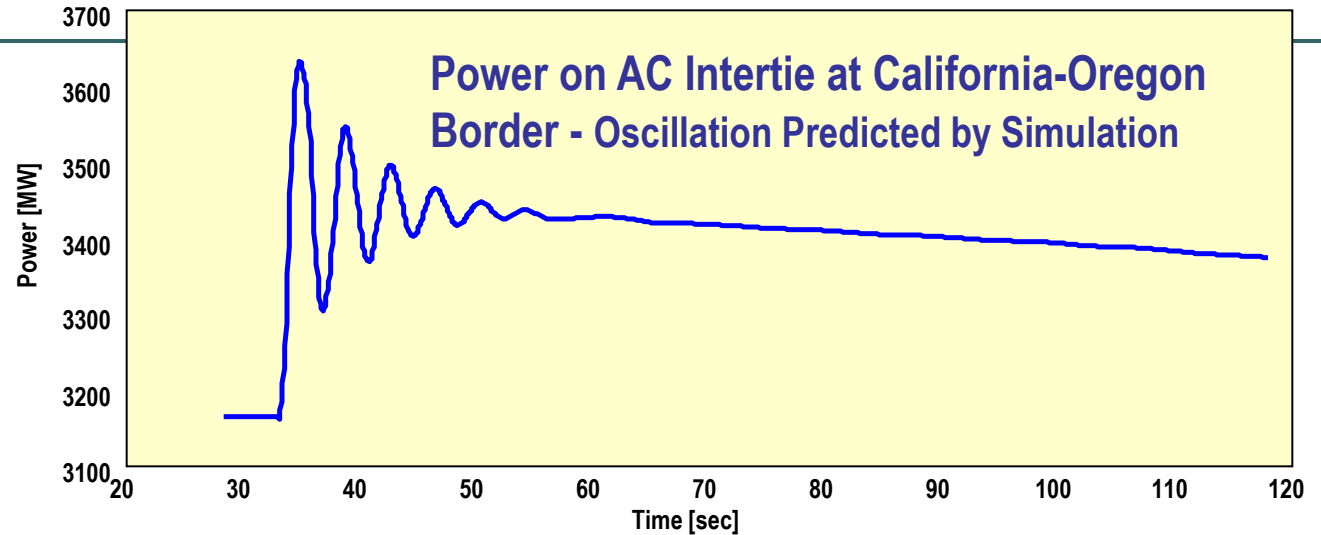

**This Is What
Actually
Happened
August 4, 2000
Oscillation -
Alberta Separation**

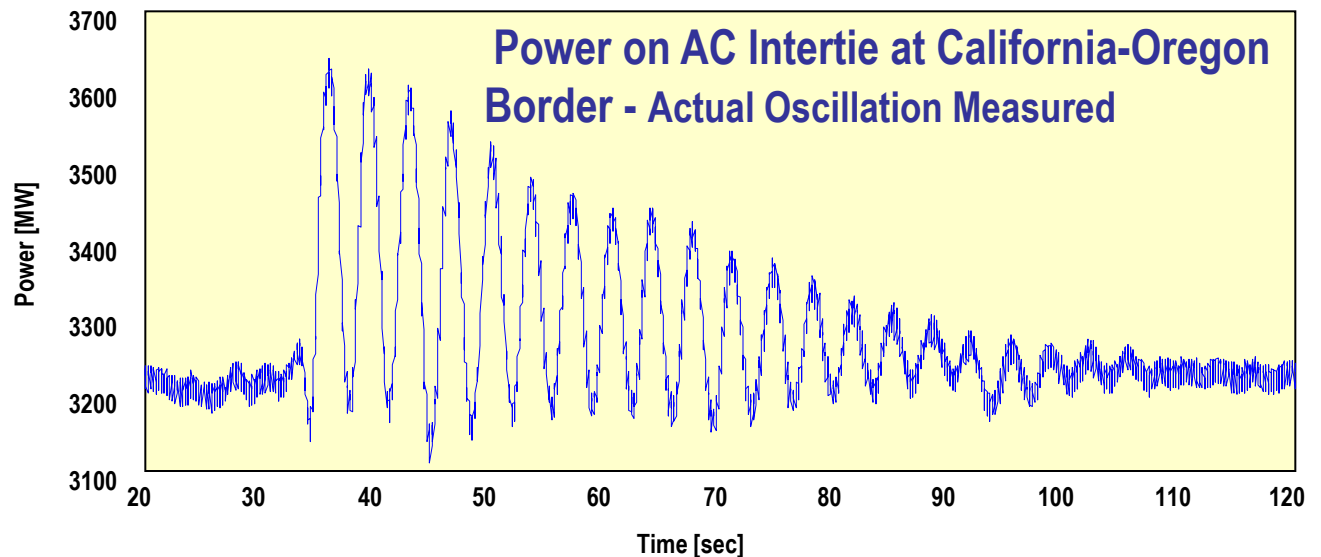

....and now, on with the Case Studies

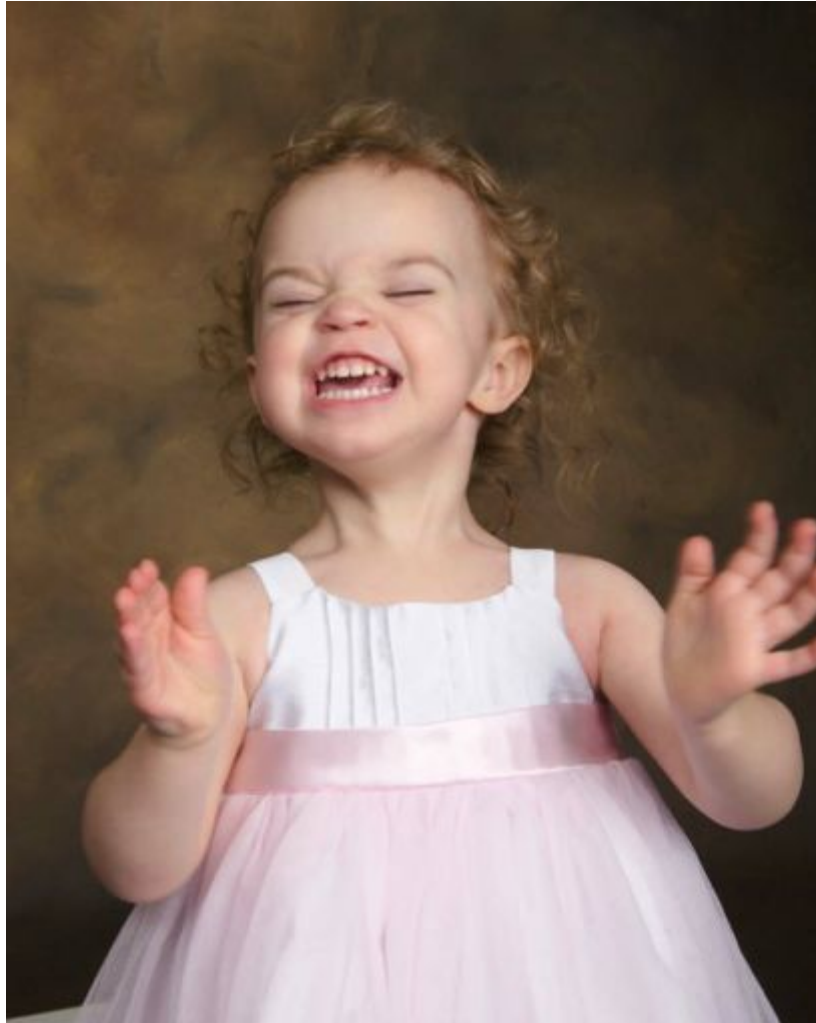

Power Plant Model Validation and Performance Monitoring

Dmitry Kosterev, Steve Yang, Pavel Etingov

NASPI Workshop

October 2103

Power System Models

- Accurate power system models are required for **reliable** and **economic** power grid operations

- 0 Failure of models to predict system behavior
- 0 7.4M customers lost power due to the outage
- 0 Major interties were de-rated temporarily by 33%
- 0 WSCC BOT required all generators >20 MVA be tested for model validation

August 10, 1996

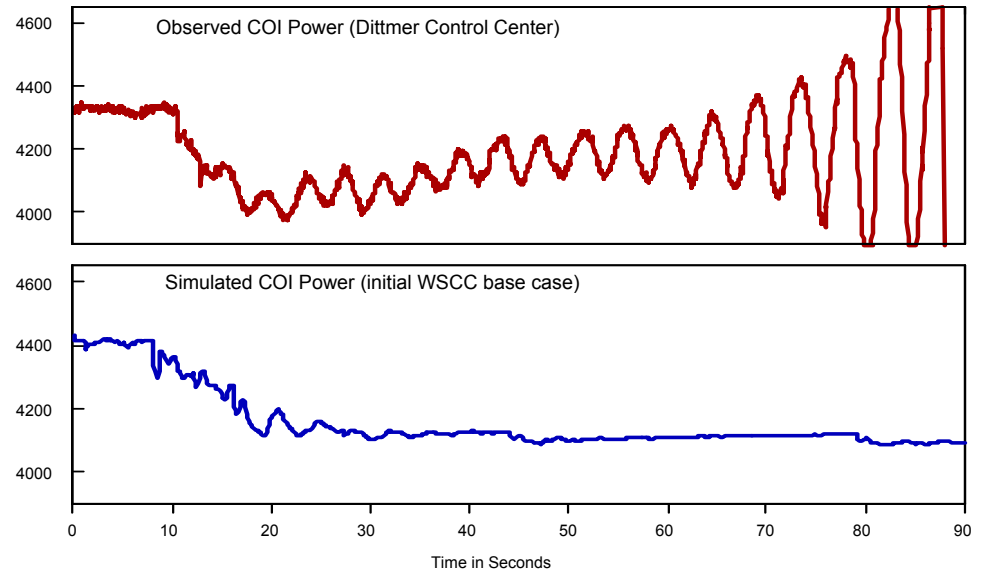

Power Plant Model Verification Requirements

- 1996 – generator baseline testing for model verification is required in WSCC
 - Benefits of WECC generator testing program are indisputable:
 - Vast majority of models needed revisions
 - Structural model errors were detected
 - Errors in control settings were identified and corrected
 - Need to sustain the model validation was apparent
- 2006 – WECC formalized its Generating Unit Model Validation Policy
 - Baseline Model Development
 - Periodic Model Validation

Reliability Standards

- 2007 – NERC started the development of model verification standards
- 2013 – NERC approved
 - NERC MOD-025 - reactive power capabilities verification
 - NERC MOD-026 – generator and excitation control model verification
 - NERC MOD-027 – generator turbine control model verification
 - NERC PRC-019 – coordination of generator protection and controls
- 2013 – NERC MOD-B effort to address FERC directives
 - Requires plant operator to provide accurate model data

Perspectives

- Generator Owner / Operator
 - Owns and operates generating unit
 - Has knowledge of their generating equipment
 - Responsible to provide accurate models to a transmission planner
- Transmission Planner
 - Uses models in system studies
 - Needs to verify that the models are usable
 - May want to have an independent way to verify model accuracy

Generator Owner

Generator Owner:

Baseline Testing vs. Model Validation

- Baseline model development
 - Needed to establish the correct model structure
 - Needed to create initial model data set
- Periodic model validation
 - Done to ensure that the models stay accurate and up-to-date **AFTER** a good model baseline is developed
 - Should not be a substitute for baseline model development

Baseline Model Development

Equipment



Model

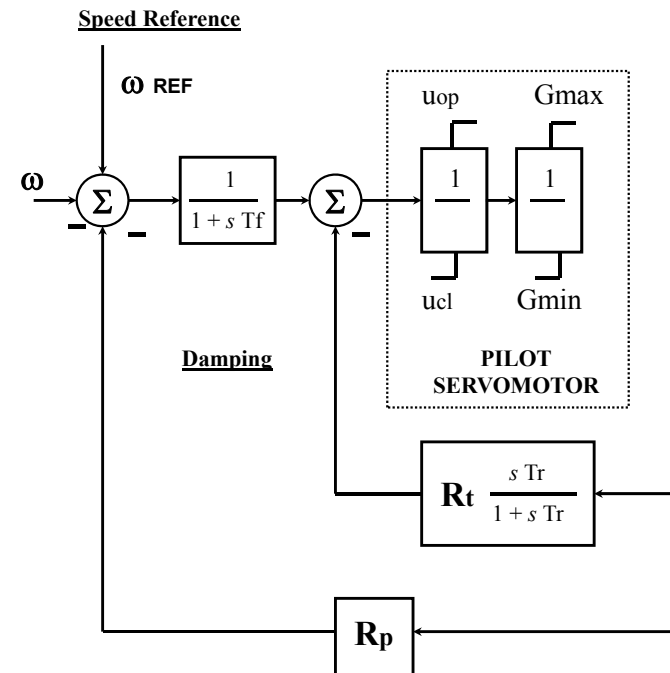

- Needed to establish the correct model structure
- Inspection of equipment and control settings
- Some tests are required
- Disturbance monitoring can complement model development

EASY



NOT



Generator Owner

- We recommend generator owners to require test and recording capabilities in new digital excitation systems and governors
 - Need to ensure recording has adequate bandwidth
- We strongly encourage generator owners to install disturbance monitors in a power plant
 - Stator three-phase voltages and currents
 - Field voltage and current
 - Governor valve position

Contact: Shawn Patterson, USBR

Transmission Planner

The same power plant tested by two consultants

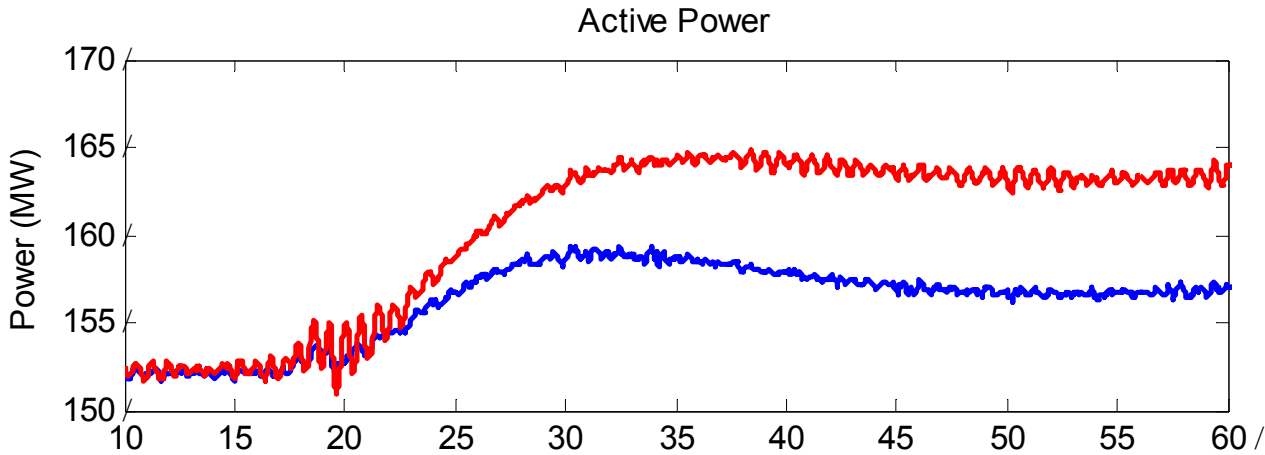

Consultant A

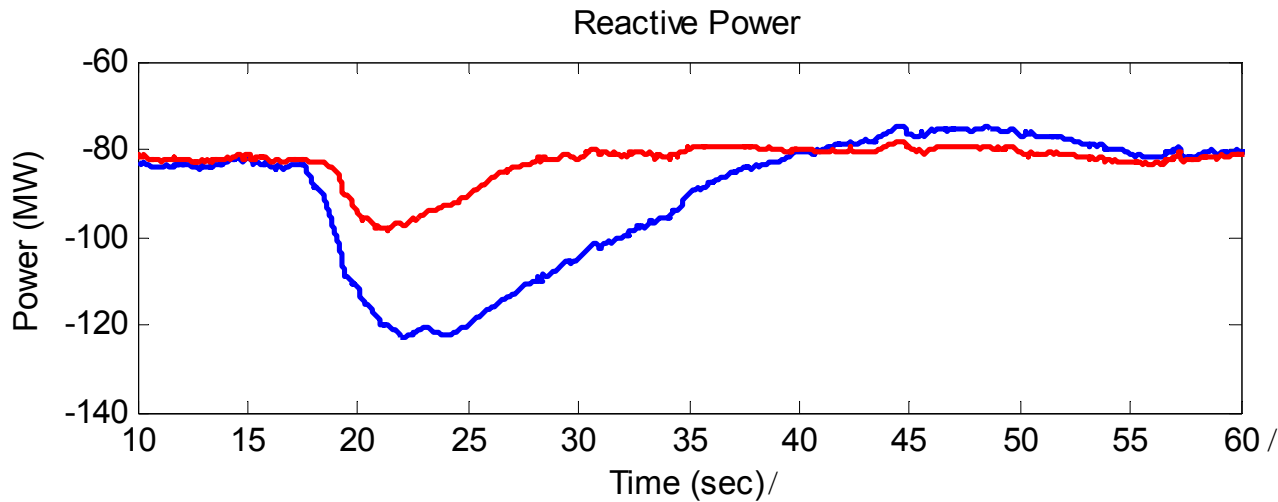

Consultant B

Which data is correct ?

You do not know unless you have an independent way of verifying

Using PMU Data for Model Validation

- BPA has installed PMUs at power plant POIs
- BPA developed Power Plant Model Validation (PPMV) application using PMU data

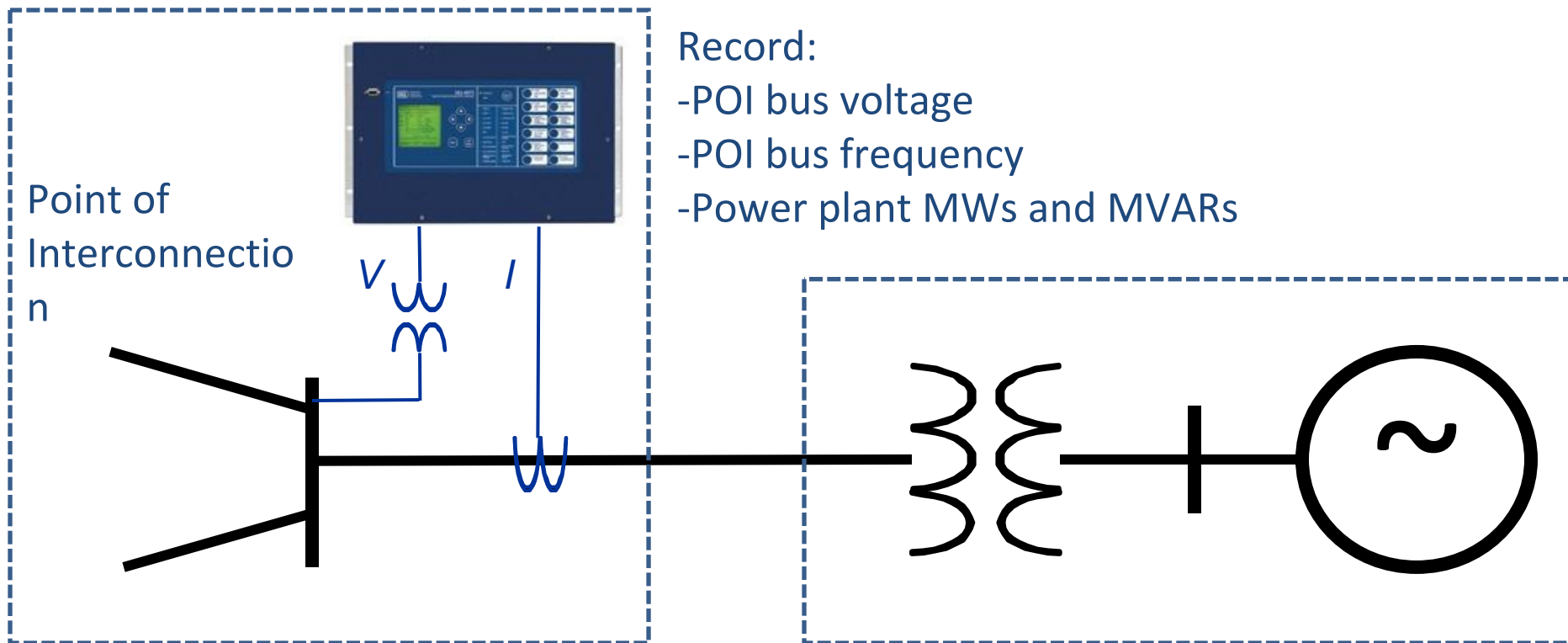

Turned out neither consultant was right

Active Power

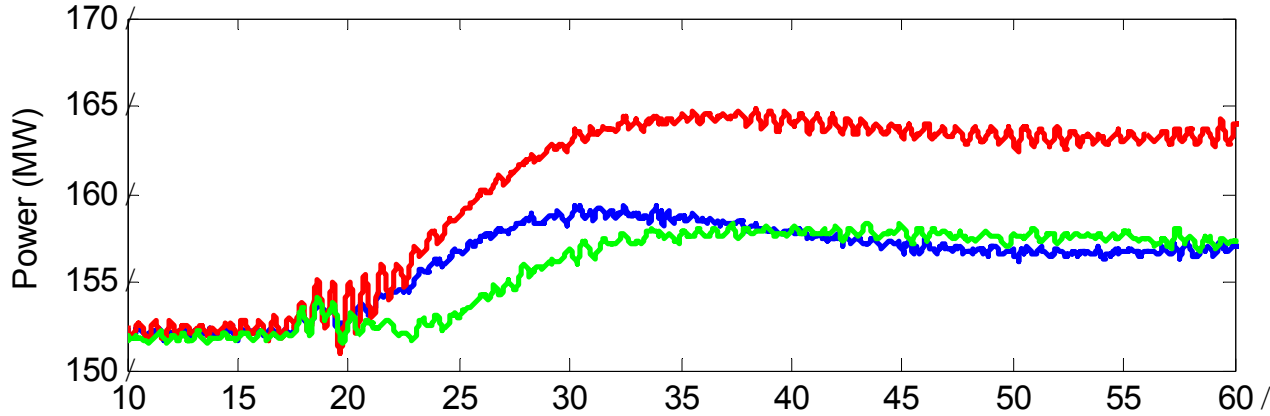

Consultant A

Reactive Power

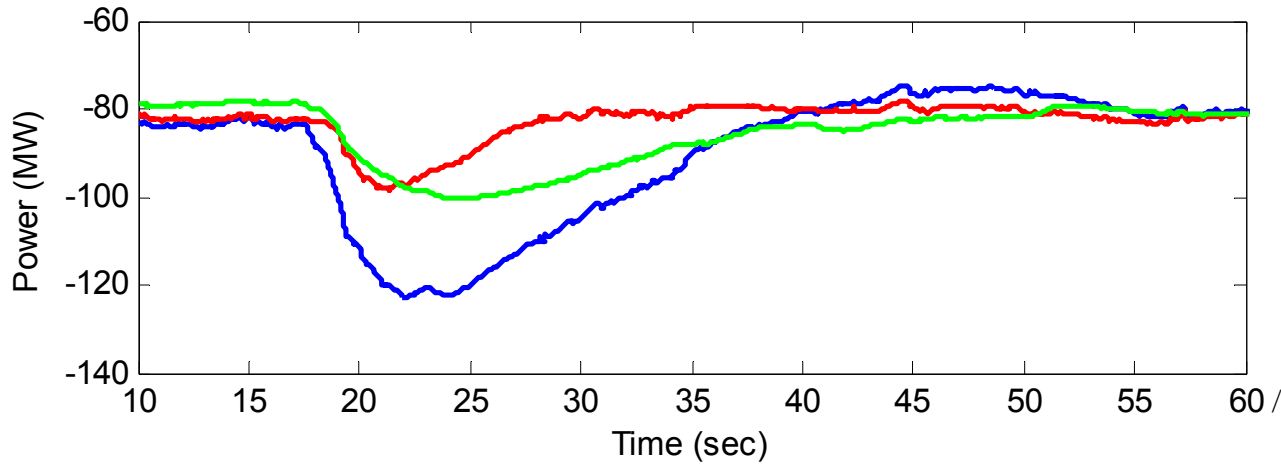

Consultant B

Reality

Power Plant Model Validation

- What a good models looks like:

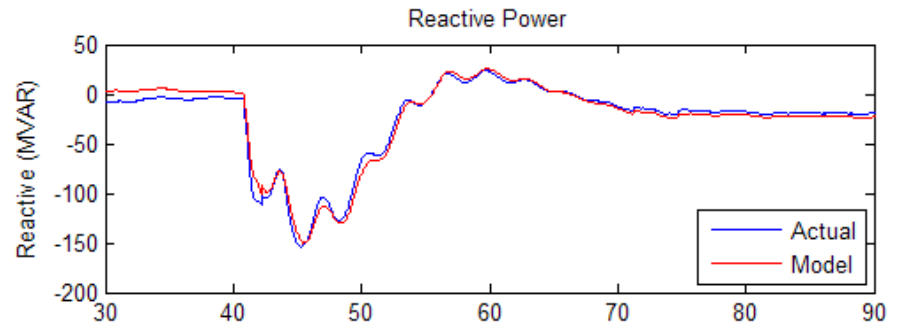
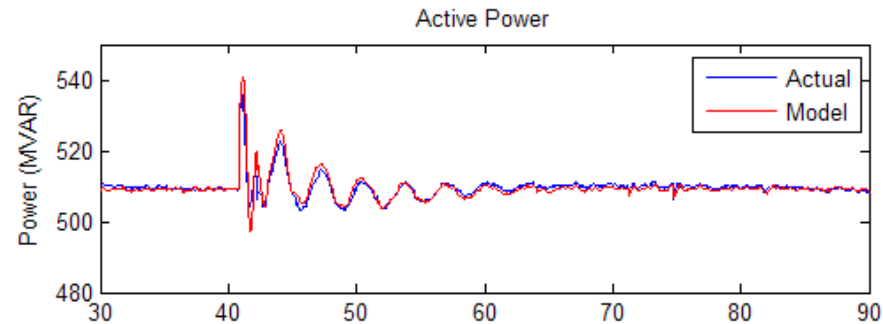
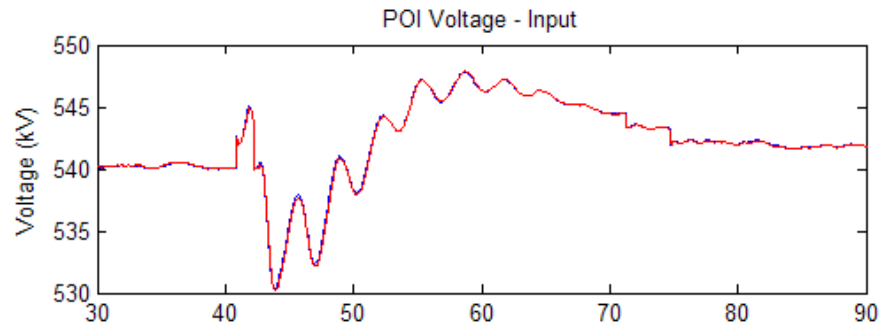
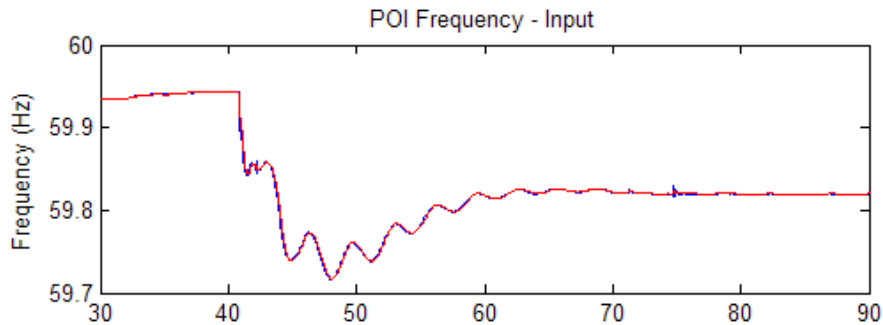

Voltage and frequency are inputs

Active and reactive power are “measures of success”

Blue line = actual recording

Red line = model

Power Plant Model Validation

- What a bad model looks like:

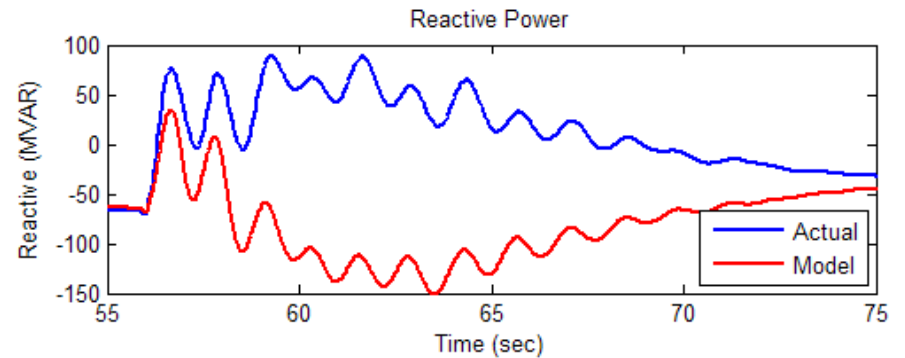
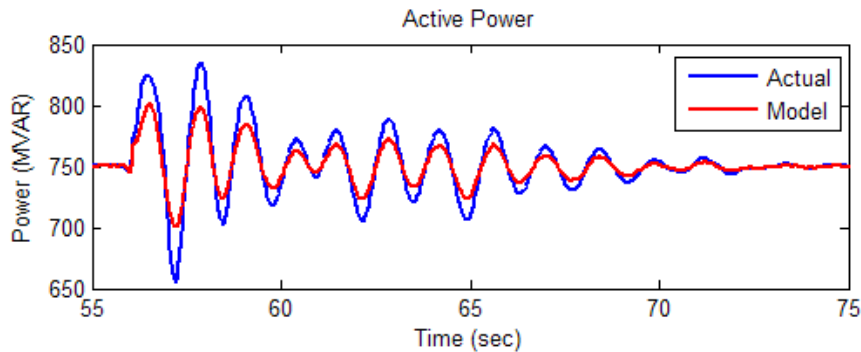
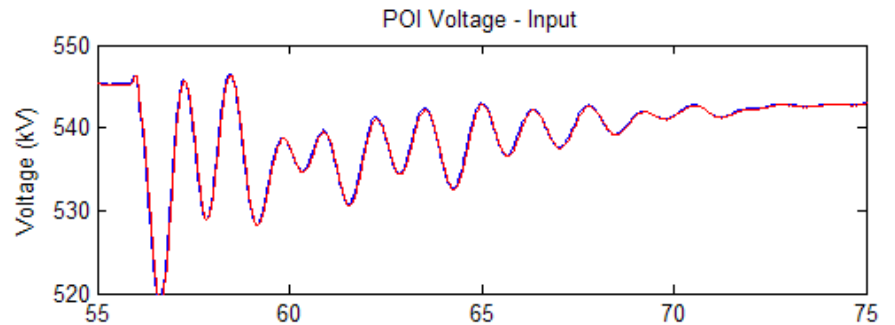
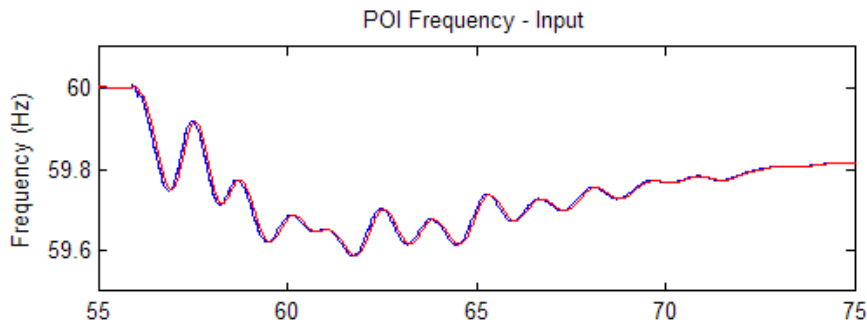

Voltage and frequency are inputs

Active and reactive power are “measures of success”

Blue line = actual recording

Red line = model

BPA Experience with Disturbance-Based Model Validation

- Most common model issues:
 - Power System Stabilizer models
 - Turbine control mode of operation / governor models
 - Generator inertia
 - Deficiencies in model structure
- Other reasons for model mismatch
 - Automatic Generation Controls
 - UEL
- “Clinical” experience:
 - Plants with modern digital systems have good models that stay accurate over time
 - Plants with legacy analog controls have most errors and tend to change in time

Frequency Responsive Plant

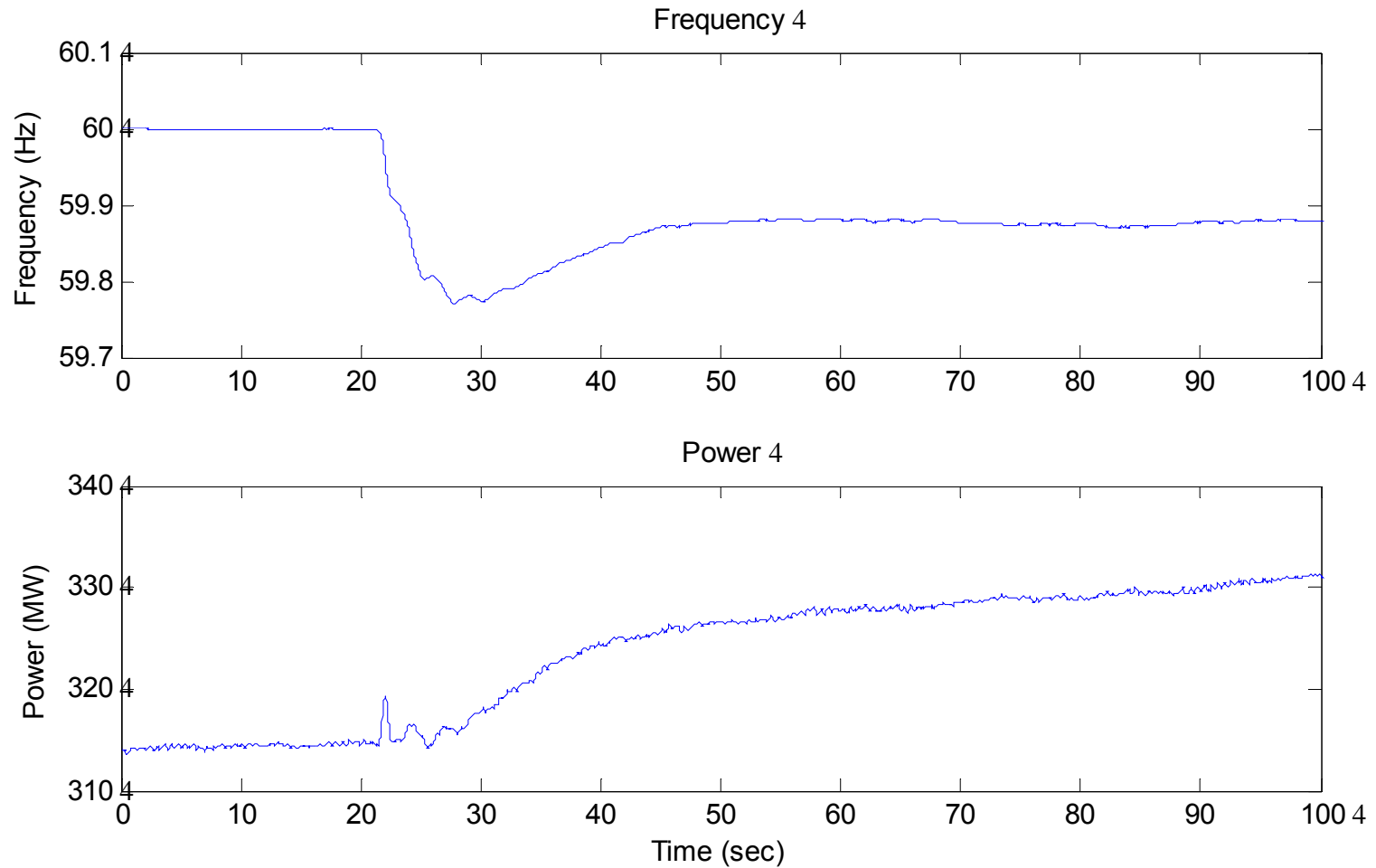

Provides sustained frequency response

“Baseloaded” Generating Unit

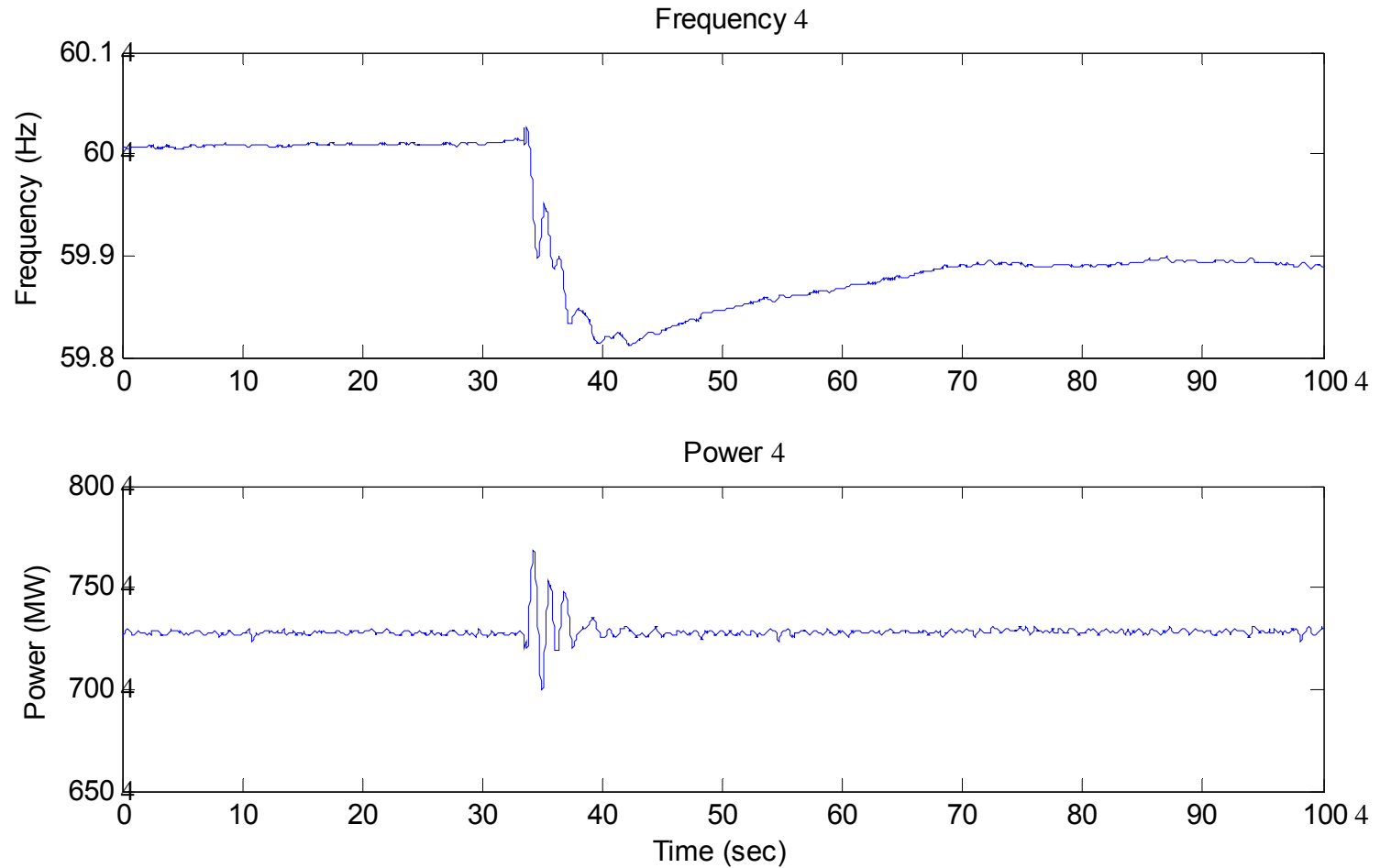

Does not respond to system frequency

Plant under Load Control

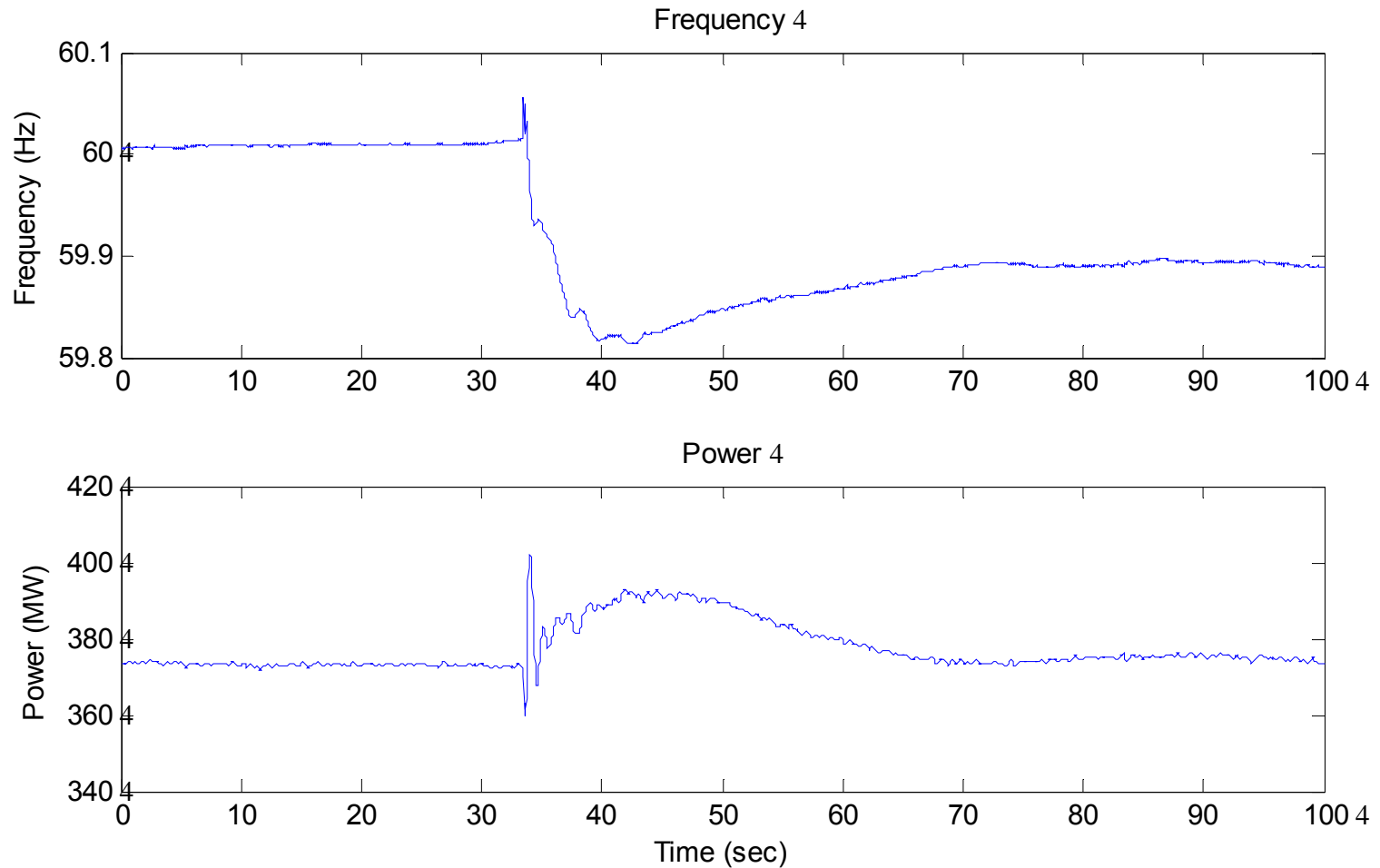

Provides initial response, but returns to the MW set-point 4

Generator Performance Monitoring

Performance Monitoring and Detecting Generator Control Failures

- Once a good baseline is developed, PMU is used for “clinical” assessment of power plant performance

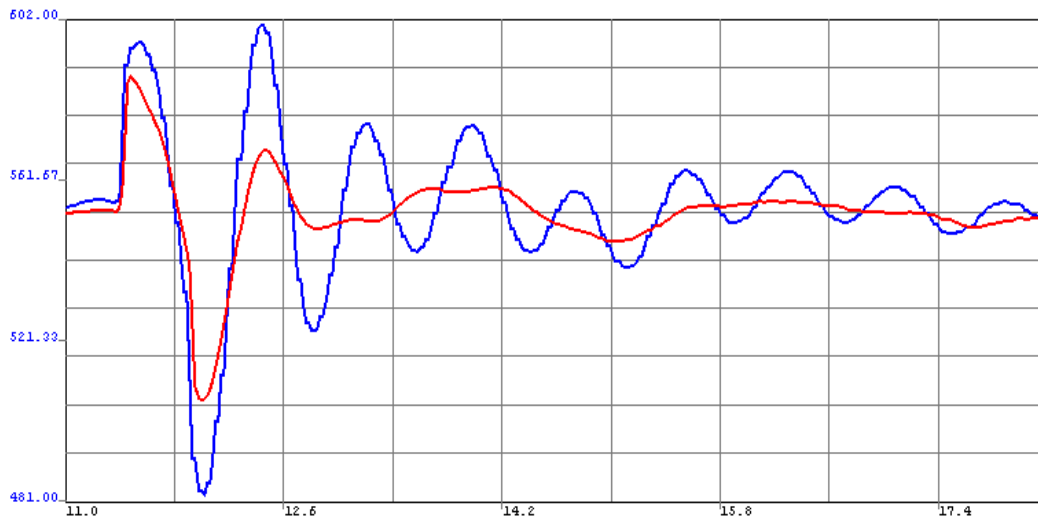

Blue line = actual response

Red line = expected response

- Controller status at the generator was indicating normal state
- PMU disturbance data indicated actual response very different from what was expected
- Power plant was contacted, controls inspected, found internal failure

Performance Monitoring Event 1

PSS ON

PSS OFF

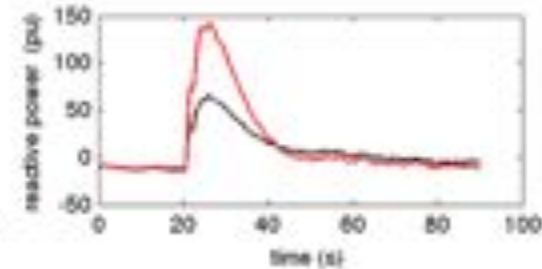
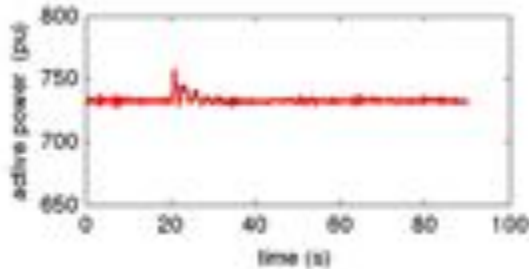
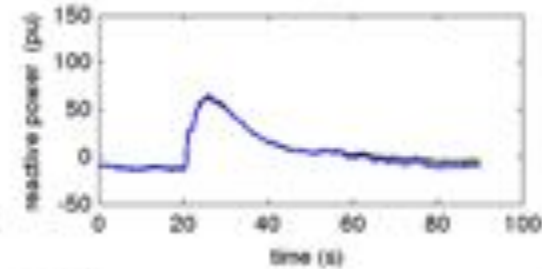
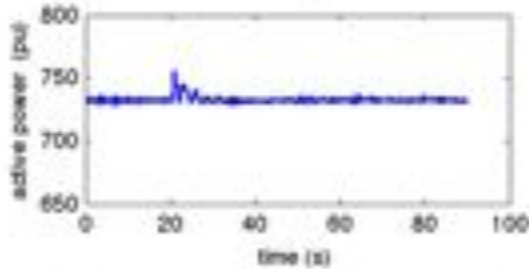
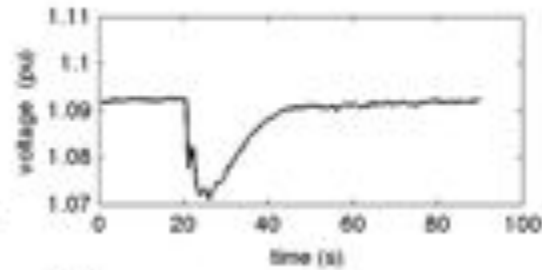
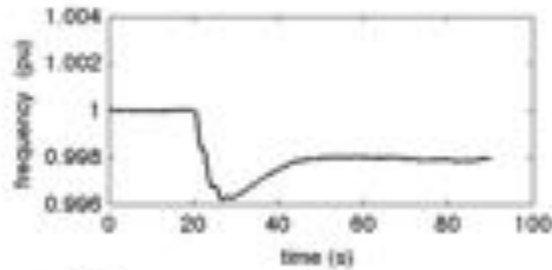

Actual PMU recording, Simulation with PSS ON, Simulation with PSS OFF

Performance Monitoring Event 3

PSS ON

PSS OFF

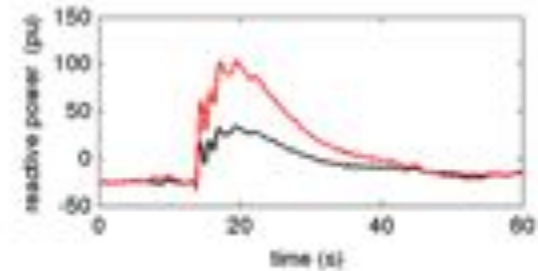
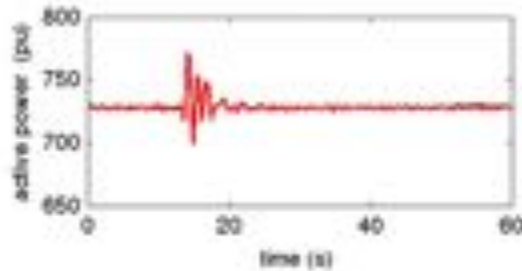
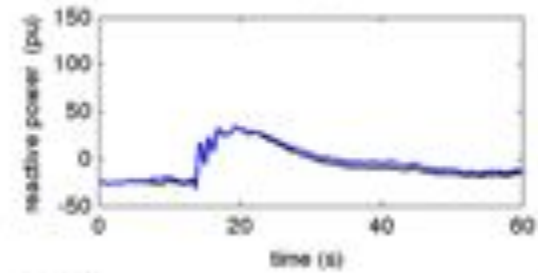
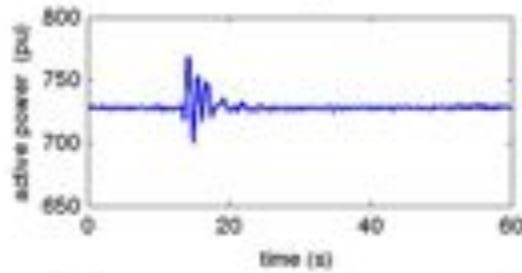
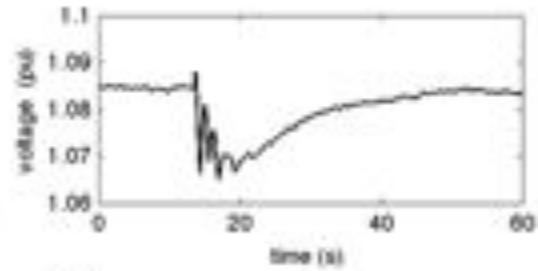
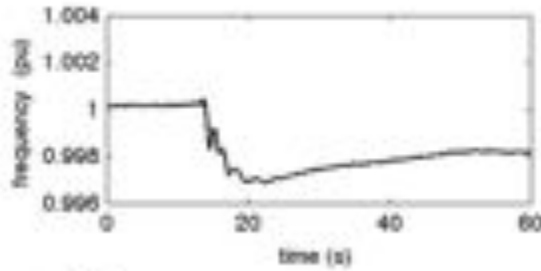

Performance Monitoring Event 4

PSS ON

PSS OFF

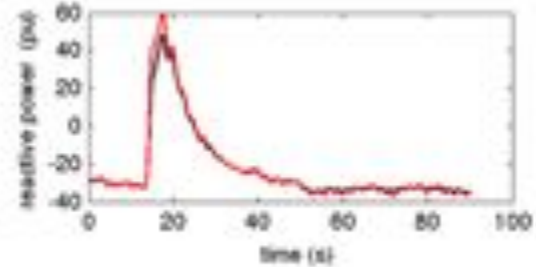
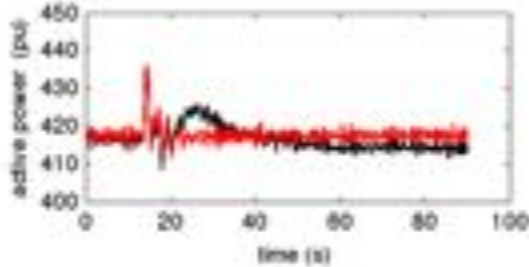
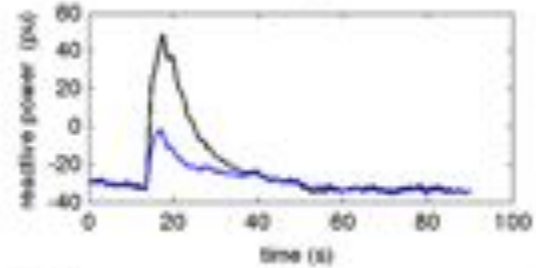
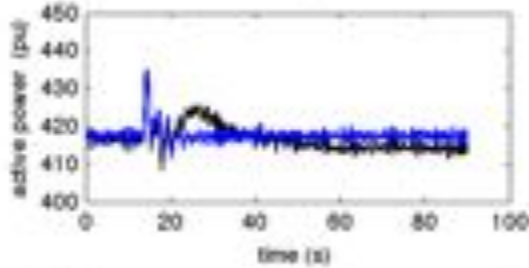
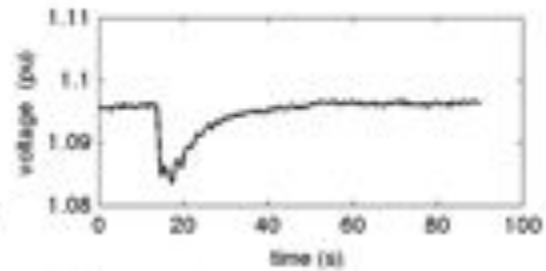
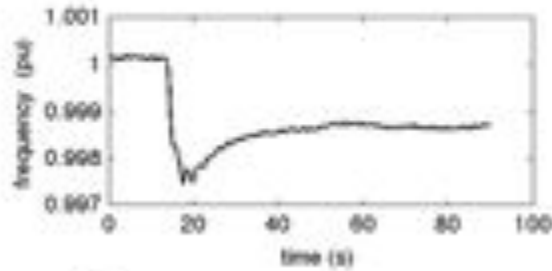

PSS failed sometime between event 3 and event 4

Performance Monitoring

Event 7

PSS ON

PSS OFF

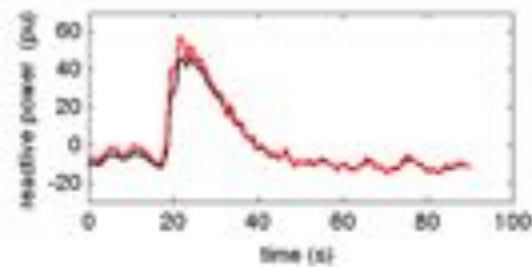
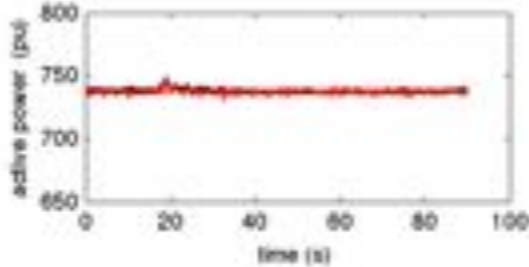
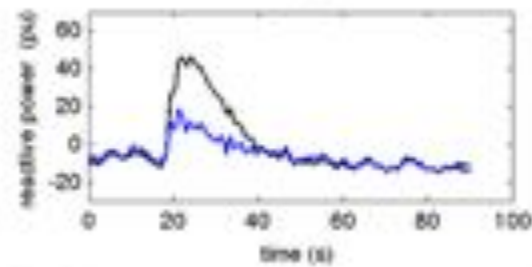
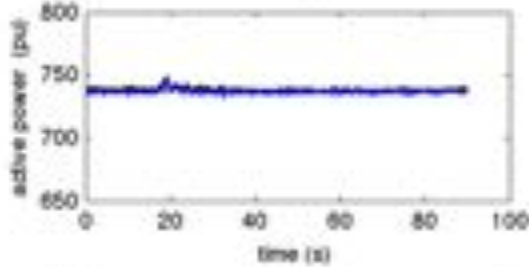
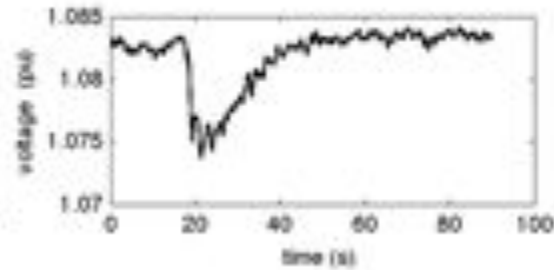
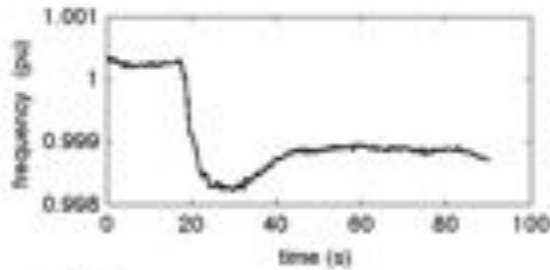

Benefits of PMU-based Model Validation

- Disturbance recordings can complement the baseline model development (e.g. TransAlta – BPA work at Centralia)
- PMU-based model validation is an acceptable method for GOs to comply with NERC MOD-026,-027
 - assuming a correct baseline model is developed
- PMU-based model validation can be used by TPs to independently verify that the models provided by GOs are accurate
 - BPA experience suggests that 60 to 70% of models did not match disturbance recordings even after the baseline test was performed
 - TPs need independent method of model verification – it is difficult to police traffic if you do not have a speed radar
- PMU-based model validation allows more frequent model verification and detection of control failures (e.g. Grand Coulee and Colstrip) than once every 10 years (per NERC) or 5 years (per WECC)

Wind Power Plants

Wind Power Plant Model Validation

- BPA, Idaho Power installed several PMUs at wind power plants
- BPA is collaborating with EPRI, NREL, Enernex, UVIG, Sandia on wind power plant model validation
- Initial results suggest more model development work is needed before models can be used in dynamic simulations

Wind Power Plant Model Validation

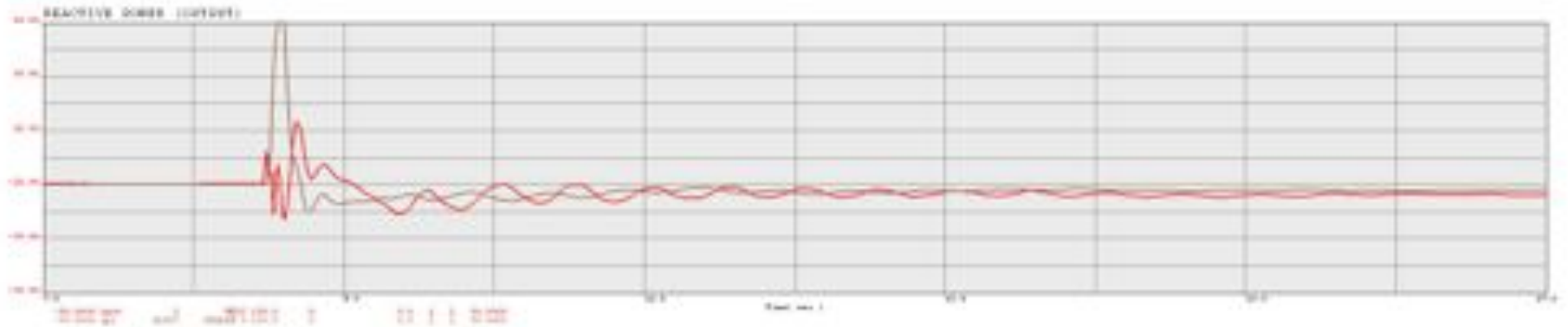
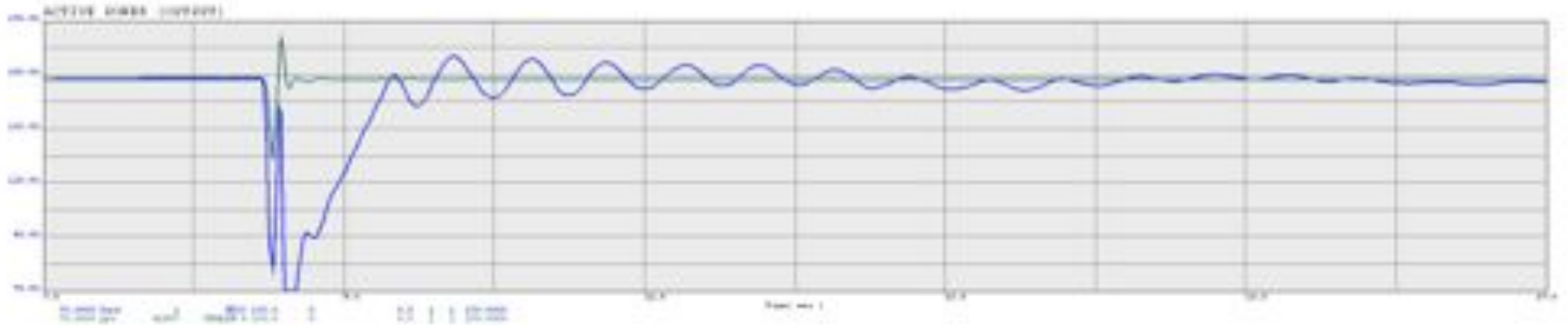

Demonstration

PPMVA_SetBaseCase_v1a.p

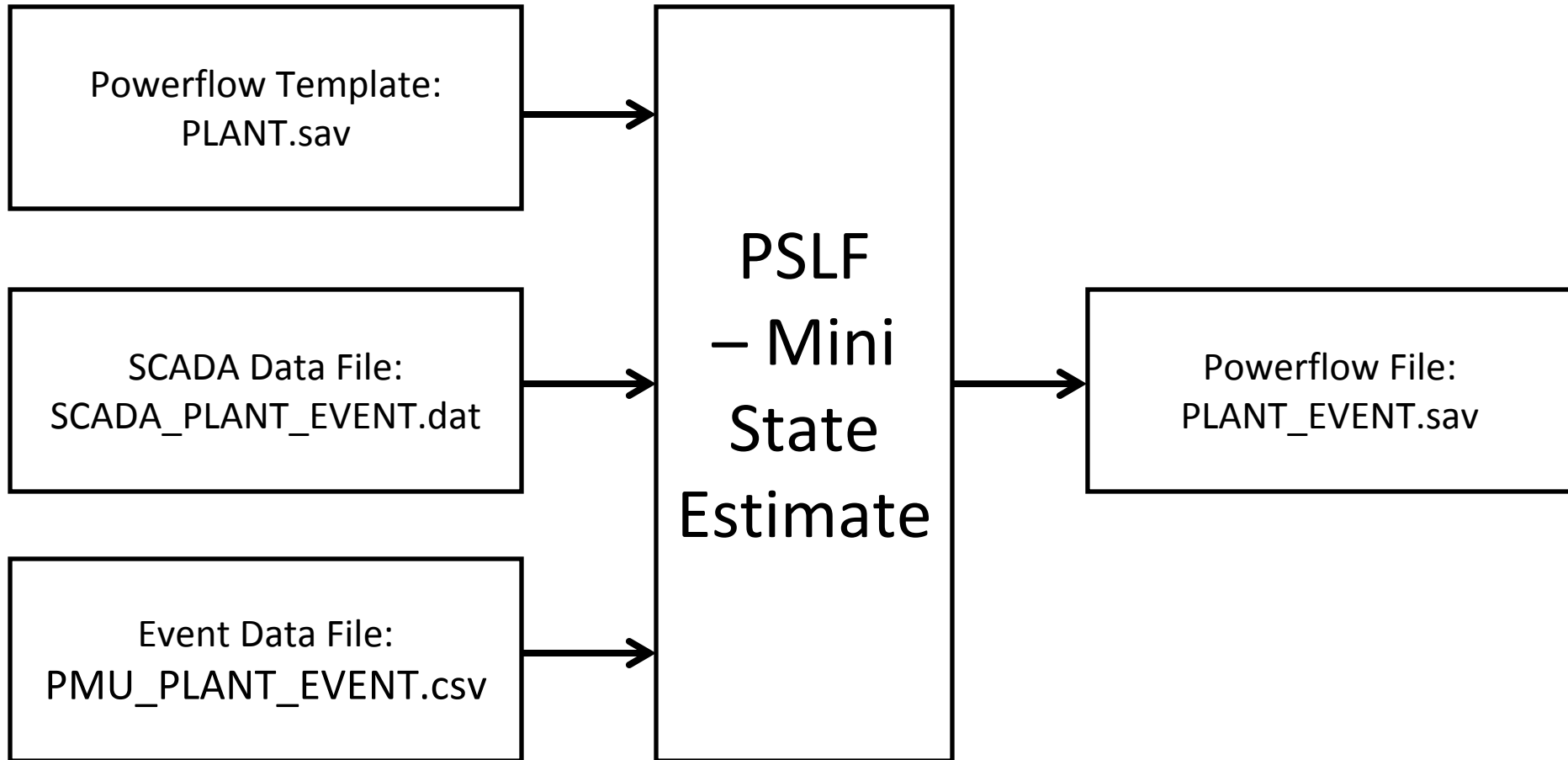

Set up a power flow with initial conditions

PMU Data File

5

Time Vact Fact Pact Qact //Head

1 **500** **60** 1 1 // Scale

0 0 0 0 0 // Offset

0 0 0 0 0 // Tf

0 0.8 0.99 0 -200 // min

160 1.2 1.01 1000 200 // max

1 1 1 1 1 // Plot

0,**542.696899**,**59.987999**,561.183899,-38.693913

0.033333,**542.686523**,**59.988998**,561.175293,-38.754639

.....

SCADA Data File

Bus Number

Bus Name

Base KV

Unit ID

Unit Status

Unit MW

Unit MVAR

Baseloaded
or
Responsive

102	"GT-01	"	18.00	"1"	1	165.0	4.2	B
103	"GT-02	"	18.00	"1"	1	155.7	4.9	B
104	"ST-12	"	16.00	"1"	1	236.2	8.5	B

PPMVA_RunValidation_v1a.p

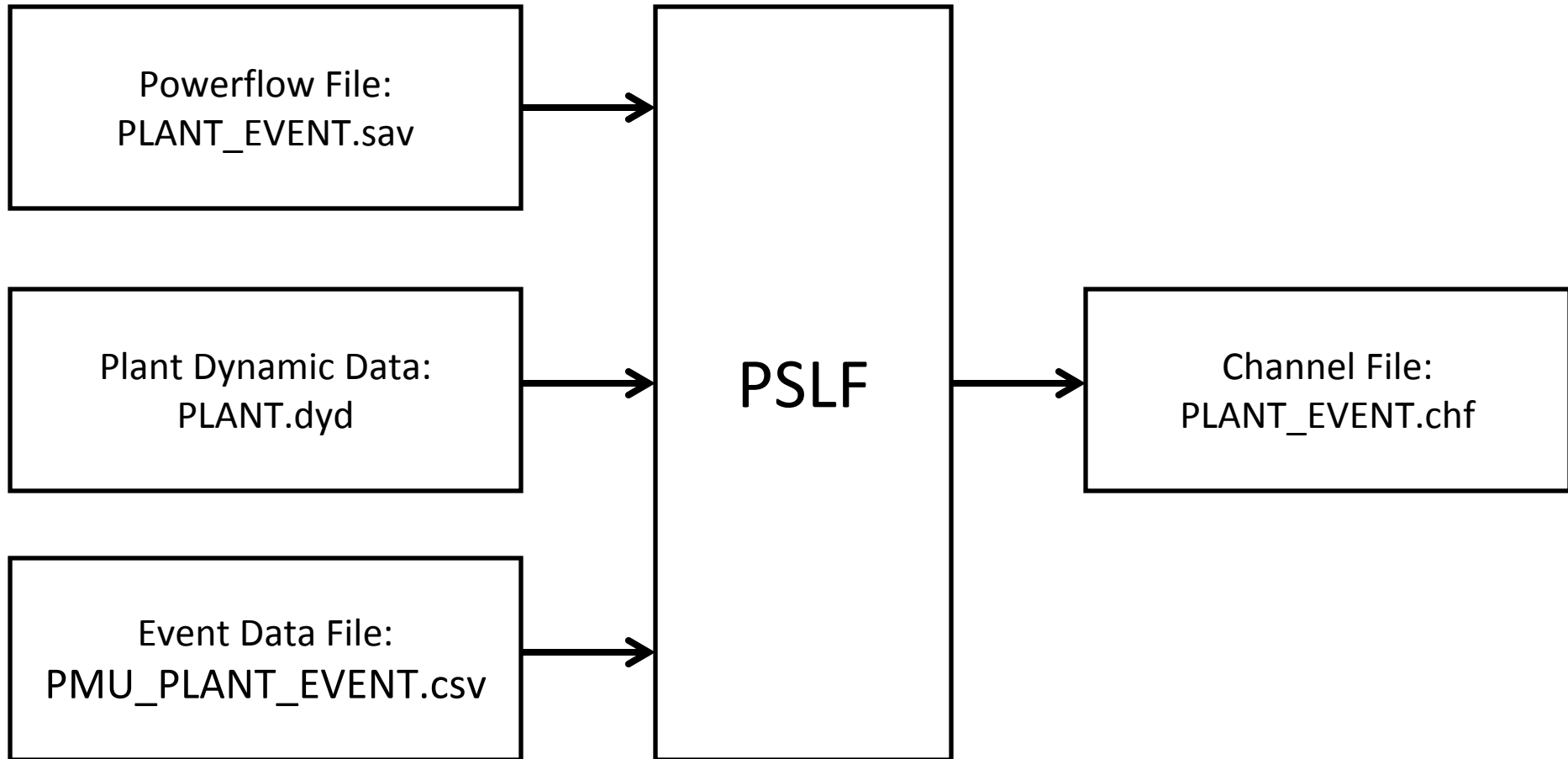

Run power plant model validation

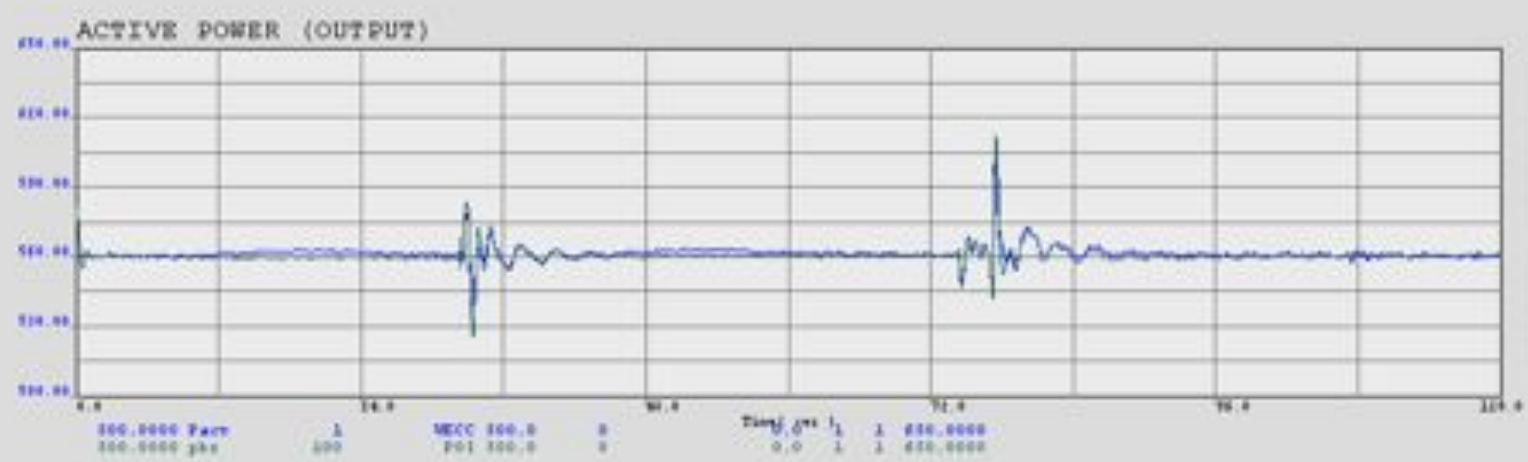
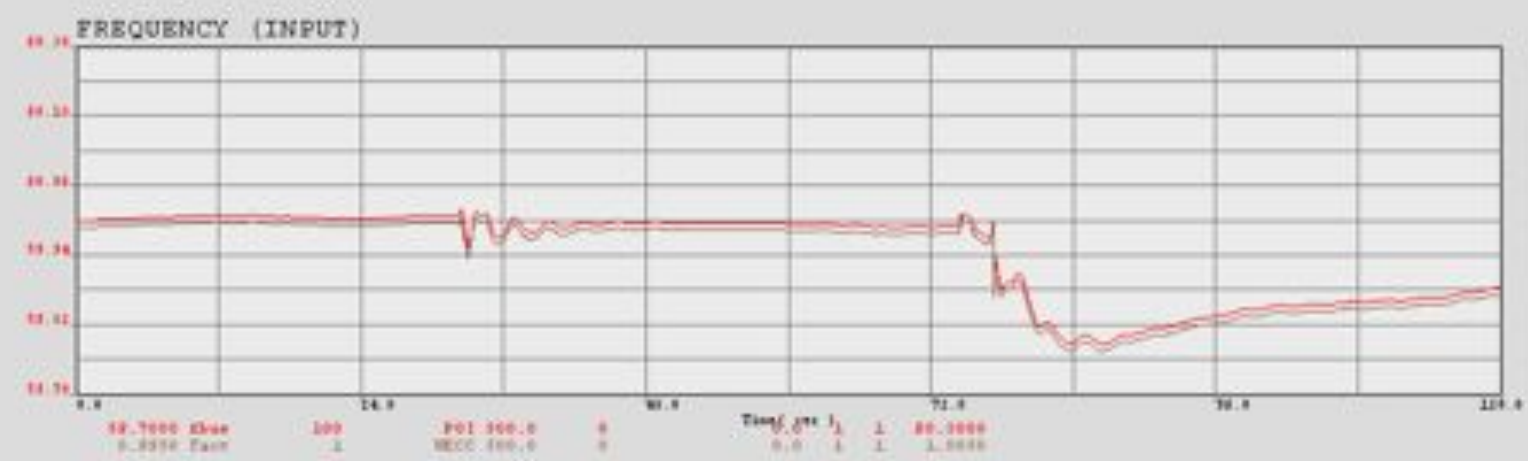

VOLTAGE (INPUT)

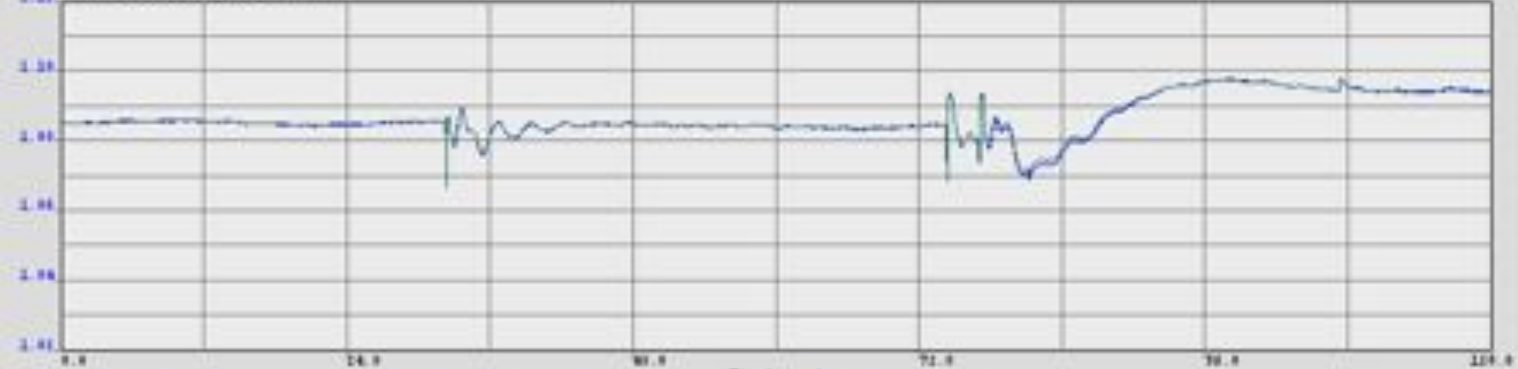

1.0000 Vrms	100	POI 100.0	0	Time/pts	1	1	1.1200
1.0000 Vavg	1	MECC 100.0	0		0.0	1	1.1200

REACTIVE POWER (OUTPUT)

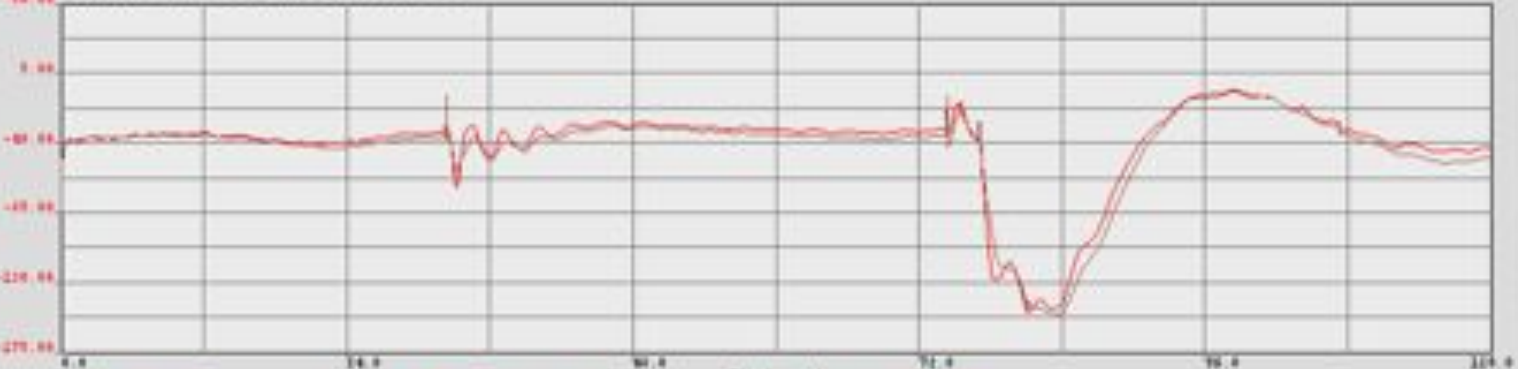

-173.0000 Vavr	1	MECC 100.0	0	Time/pts	1	1	10.0000
-173.0000 Vpr	100	POI 100.0	0		0.0	1	10.0000

Model Calibration

Model Calibration

- Initially, BPA use of the PMU data has been limited to validating dynamic models of power plants:
 - used for pass / fail checking
 - no model adjustments are made should the model be wrong

Model (in)Validation

Simulations done using a model from WECC dynamic data base

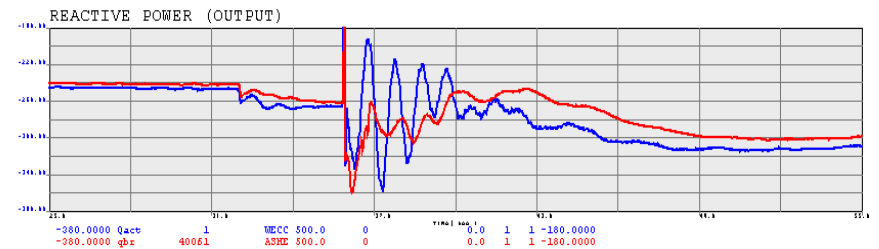
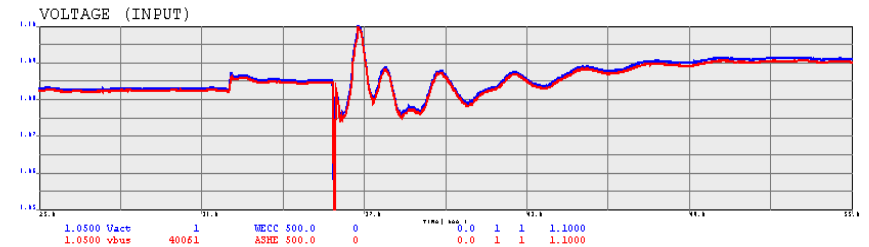
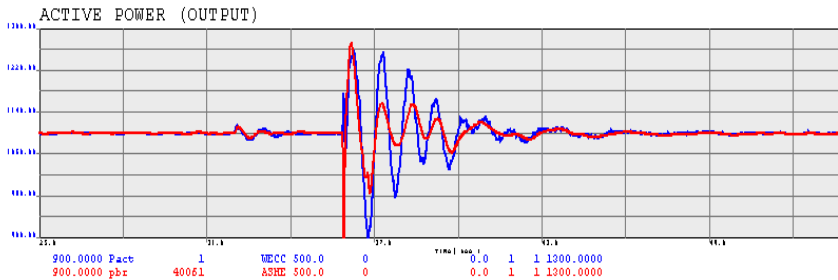
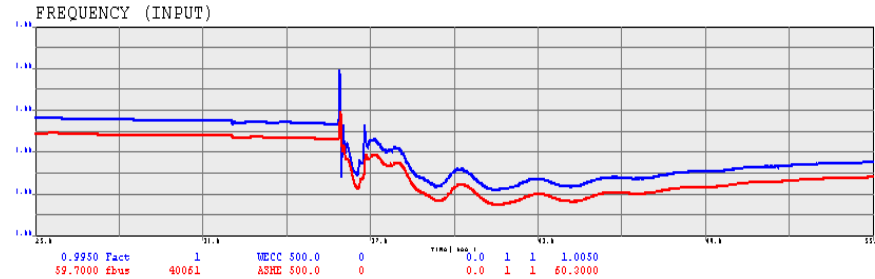

Blue = actual
Red = simulated

Model Calibration

- DOE is funding several researchers to do work on power plant model calibration using PMU data
 - PNNL (Kalman filter)
 - Sakis Meliopolis, Georgia Tech (super-calibrator)
 - Bernard Lesieutre, University of Wisconsin (pattern matching)
 - Wei-Jen Lee, University of Texas (particle swarm optimization and non-linear optimization)
- EPRI is also working on PMU-based model calibration
- BPA has worked with Bernie Lesieutre to perform model calibration for CGS and Colstrip

Model Calibration

Simulations done using a calibrated model

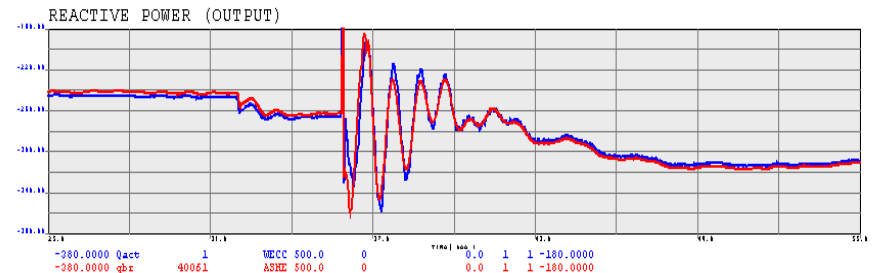
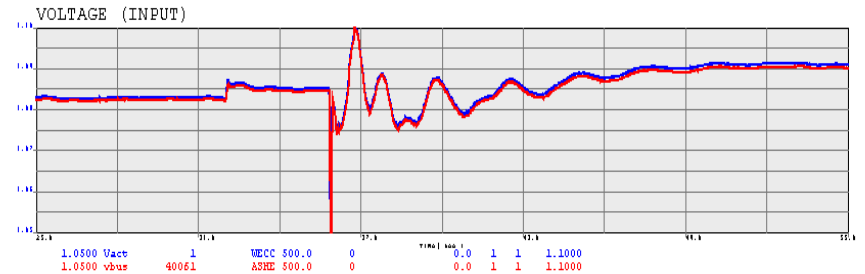
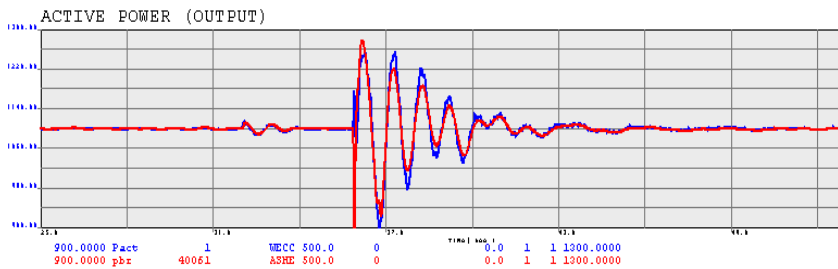
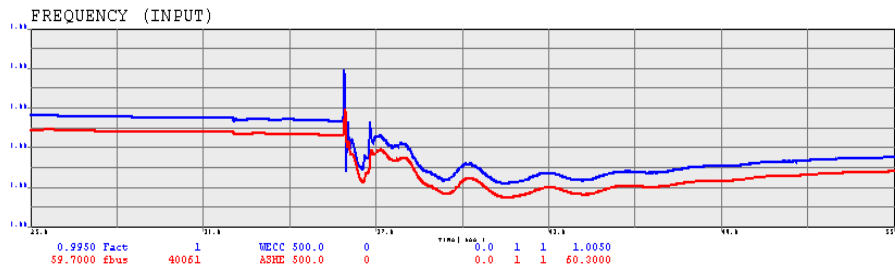

Blue = actual
Red = simulated

Model Calibration

Simulations done using a calibrated model

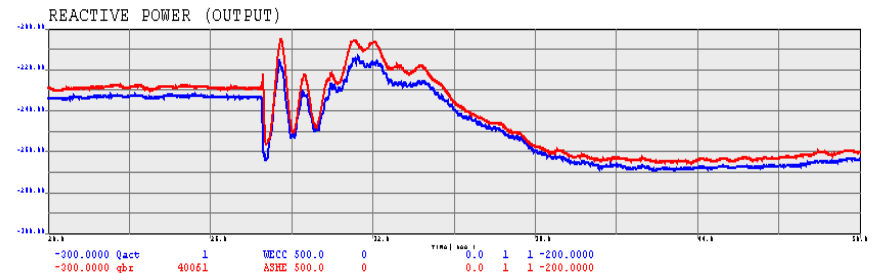
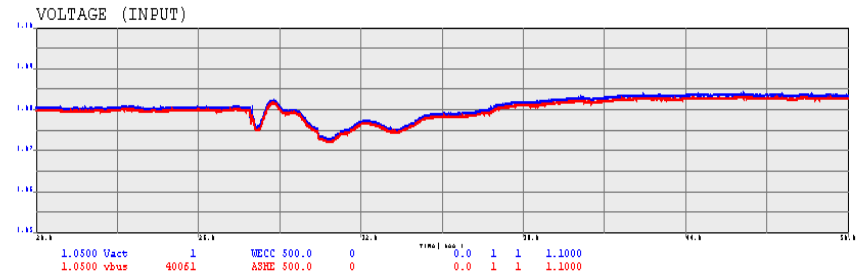
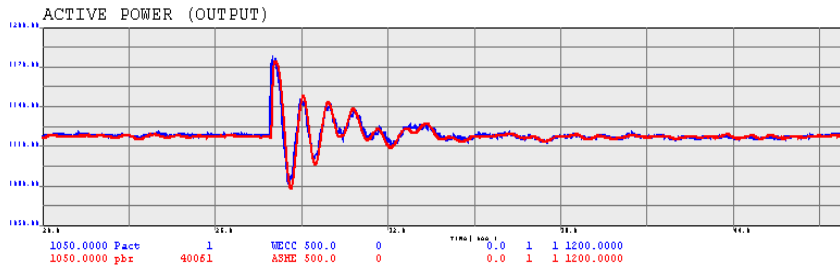
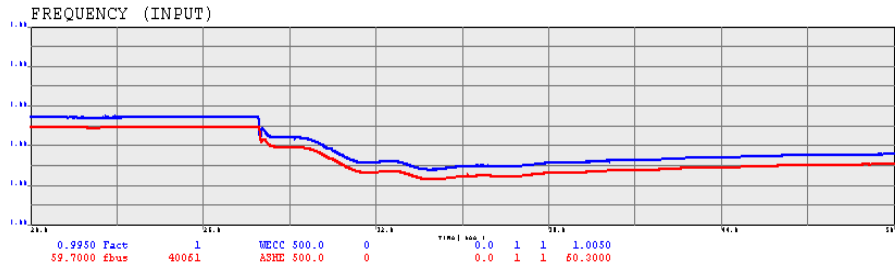

Blue = actual
Red = simulated

Contact Information

- Dmitry Kosterev, BPA, dnkosterev@bpa.gov
- Steve Yang, BPA, hyang@bpa.gov
- Pavel Etingov, PNNL, Pavel.Etingov@pnnl.gov
- Bernie Lesieutre, University of Wisconsin
- Shawn Patterson, USBR

NASPI TECHNICAL WORKSHOP: * *MODEL VALIDATION USING SYNCHROPHASOR DATA &*

TUESDAY, OCTOBER 22, 2013 *
Crowne Plaza Chicago O'Hare Hotel *
5440 N. River Rd. *
Rosemont, Illinois 60018 *

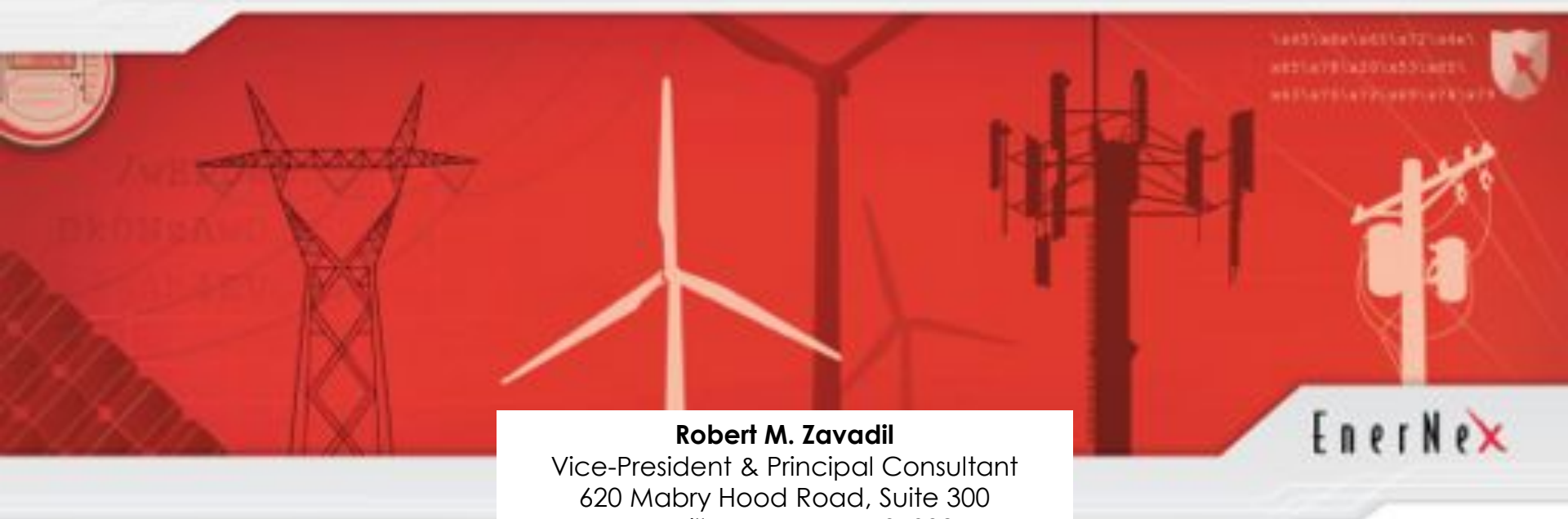

Robert M. Zavadil
Vice-President & Principal Consultant
620 Mabry Hood Road, Suite 300
Knoxville, Tennessee 37932
Tel: (865) 218-4600 ext. 6149
bobz@enernex.com
www.enernex.com

EnerNex

Renewable Plant Model Validation Activities

- ▶ Utility Variable Generation Integration Group
- ▶ Initial support from BPA, DOE Office of Electricity
- ▶ Objectives
 - Inventory operating wind plants with POI monitoring (PMU or other device)
 - Determine if event data appropriate for model validation has been collected
 - Perform plan validation with field data
- ▶ Approach
 - Transient turbine and plant models (allow direct simulation of asymmetrical events) for initial validation
 - PSS/E or PSLF models validated against transient model
- ▶ Project Team
 - EnerNex
 - Hydro Quebec/IREQ
 - BPA

Validation Attempt for OG&E

- ▶ OG&E presentation at 6/12 NASPI mtg.
- ▶ Significant wind generation, substantial PMU data
- ▶ Data provided to EnerNex by Austin White

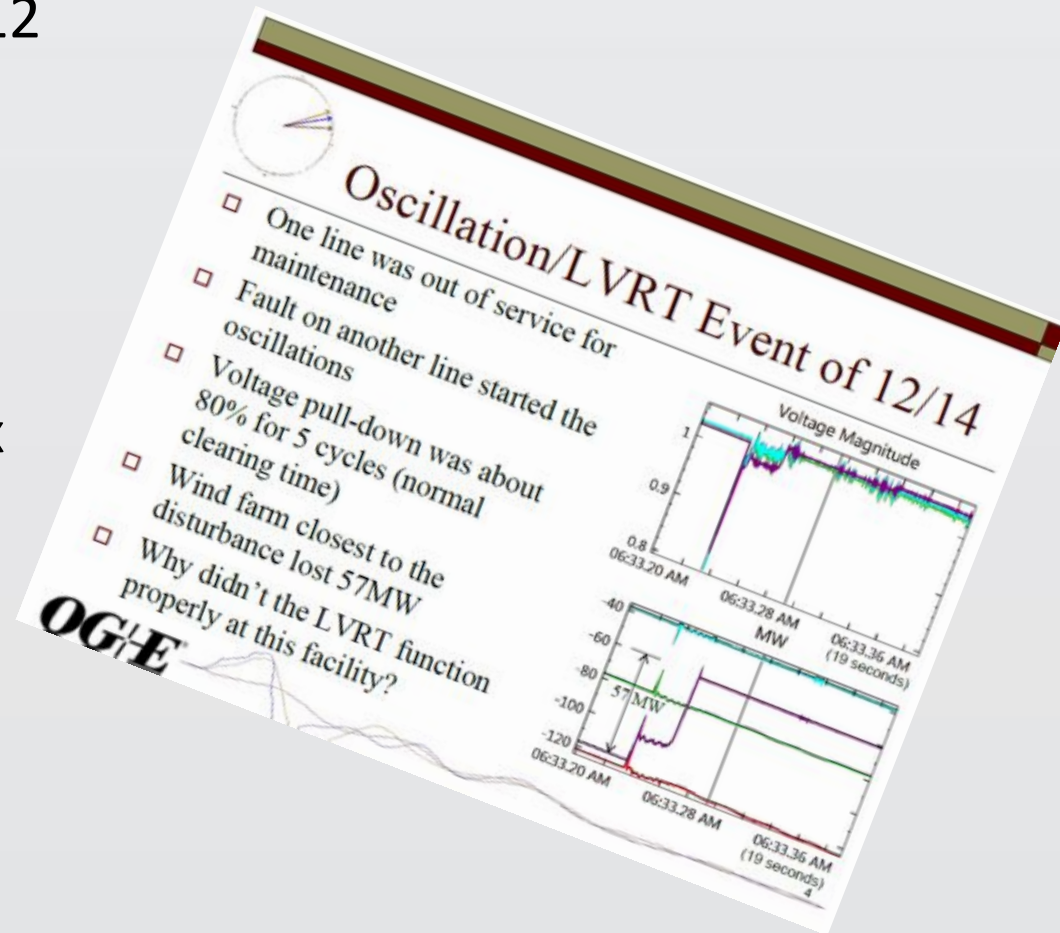

OG&E PMU Data

- ▶ Large number of recorded events screened
- ▶ Many were “small signal” – i.e. slight changes in terminal voltage
- ▶ Looking for large disturbances

Complex event record with embedded large disturbance

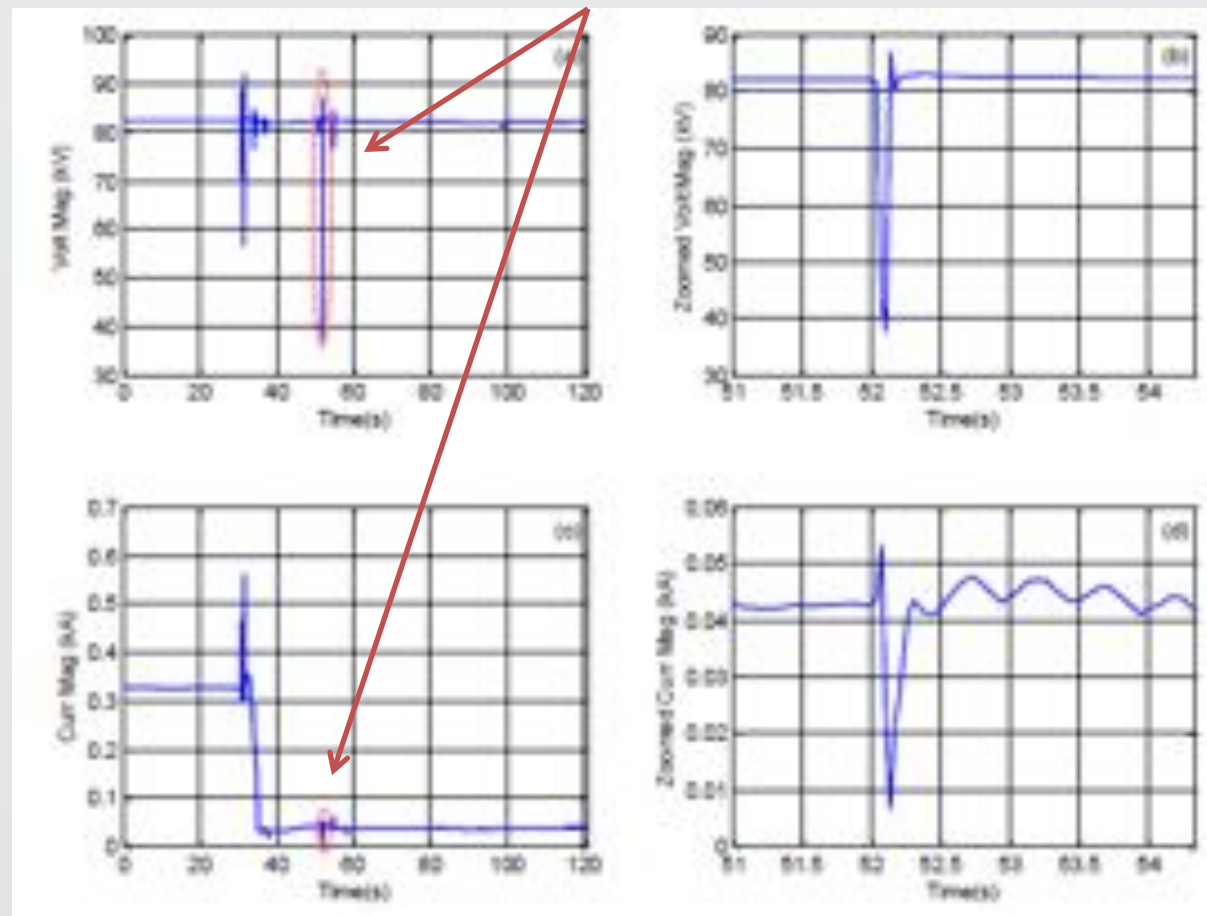

Analysis

- ▶ Basic information about plant obtained from OG&E
- ▶ Type III generic model used to represent turbines
- ▶ Parameter sensitivity analysis conducted to iteratively adjust aggregate turbine model

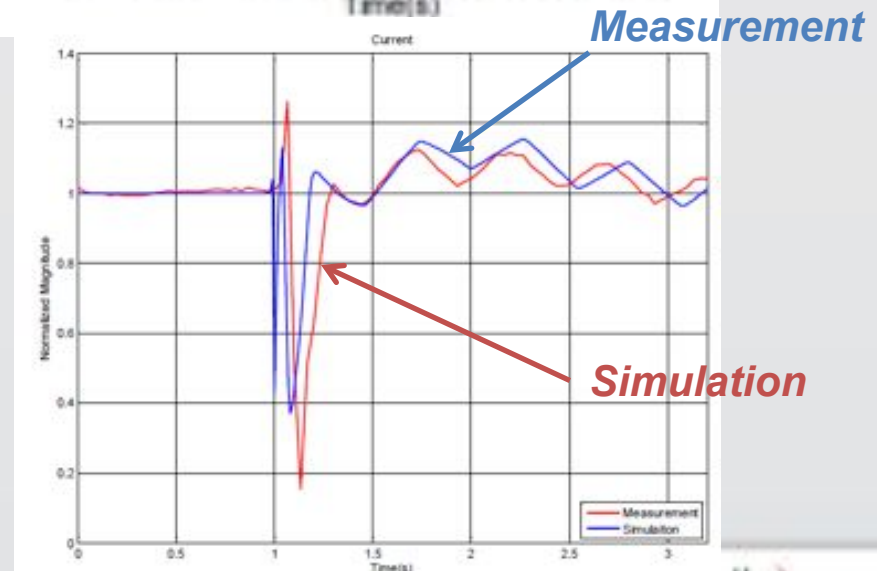
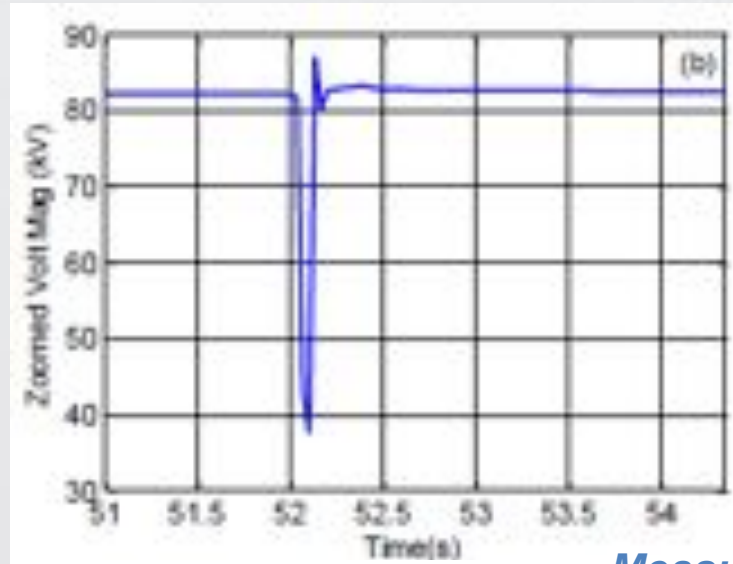

Results

- ▶ Simulation/measurement correspondence is “reasonable”, but...
- ▶ Maybe more of a supporting data point than validation...
- ▶ What is “validation”, anyway?

Lessons Learned

- ▶ Even with wide-scale deployment of PMU's, good data for validation is hard to come by.
- ▶ Good data is important, but not the only information requirement
- ▶ Participation of Transmission owner, plant operators in validation process would be very beneficial
- ▶ 1st generation of generic models may be lacking (good news: 2nd generation imminent)
- ▶ Validation process itself needs more formalization

Challenges

- ▶ A specific event may be hard to replicate via simulation
 - Plant model complexities
 - Initial conditions/system state
 - Origin and nature of system disturbance
- ▶ Actual events will be asymmetrical
 - PSS/E, PSLF models are positive sequence only
 - Unbalanced events model very approximately
 - 3-phase faults are rare
- ▶ Events are infrequent
 - With just a few monitored locations, appropriate data for validate may be long in coming
 - Can be partially remedied by monitoring at many locations
- ▶ Large number of commercial turbines to validate (60 GW + wind, 10 GW solar installed capacity = **100's of bulk power plants**)

- ▶ New initiative
- ▶ Under the UVIG Modeling & Interconnection User Group
- ▶ Mission is to provide a venue for periodic and ongoing information sharing re: model validation
- ▶ UVIG will provide mechanism for information dissemination (modeling Wiki)
- ▶ Will meet twice yearly (prior to UVIG Spring & Fall workshops)
- ▶ Special workshop to be held 2Q 2014 (info forthcoming)



Thanks

▶ Be on lookout for Spring workshop details...

www.variablegen.org

Approaches for Model Validation

- ▶ Various methods can and have been used
- ▶ All have advantages and disadvantages

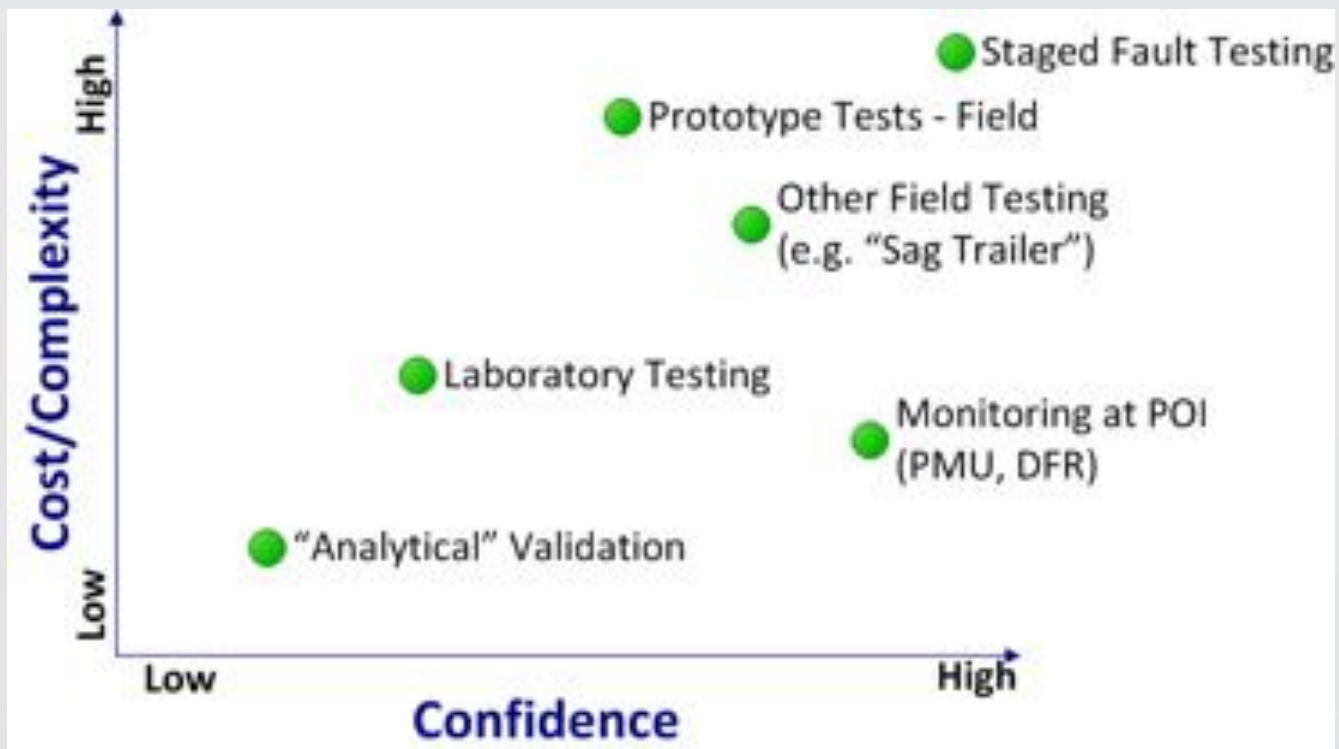



Model Validation of SVC and STATCOM Using PMU Data

Pouyan Pourbeik, EPRI

George Stefopoulos, NYPA

NASPI Technical Workshop: Model Validation using Synchrophasor Data

October 22, 2013

Rosemont, IL



AGENDA

- Project scope and information
- Model development background
- Model identification and validation process
- Example validation results

PROJECT BACKGROUND

- Identify dynamic models for NYPA's static VAr systems:
 - STATCOM (Marcy Convertible Static Compensator)
 - SVC (Refurbished device)
- Use generic models previously developed by EPRI
- Utilize phasor measurements obtained by NYPA's synchrophasor network
 - Part of synchrophasor research
 - Supported via NYISO's SGIG project

BACKGROUND ON TECHNOLOGIES AND MODELS



NEW MODELS DEVELOPED IN 2010/2011

- Developed thorough collaboration with WECC and vendors [1] & [2]
- Released in major commercial tools (GE PSLF™, Siemens PTI PSS®E)
 - SVSMO1 – model of a TCR-based SVS
 - SVSMO2 – model of a TSC/TSR-based SVS
 - SVSMO3 – model of a VSC-based SVS
- **These are generic models intended for emulating the majority of SVS systems, they are NOT an exact representation of any actual control strategy**

GENERIC MODEL SVSMO1 – FOR SVC

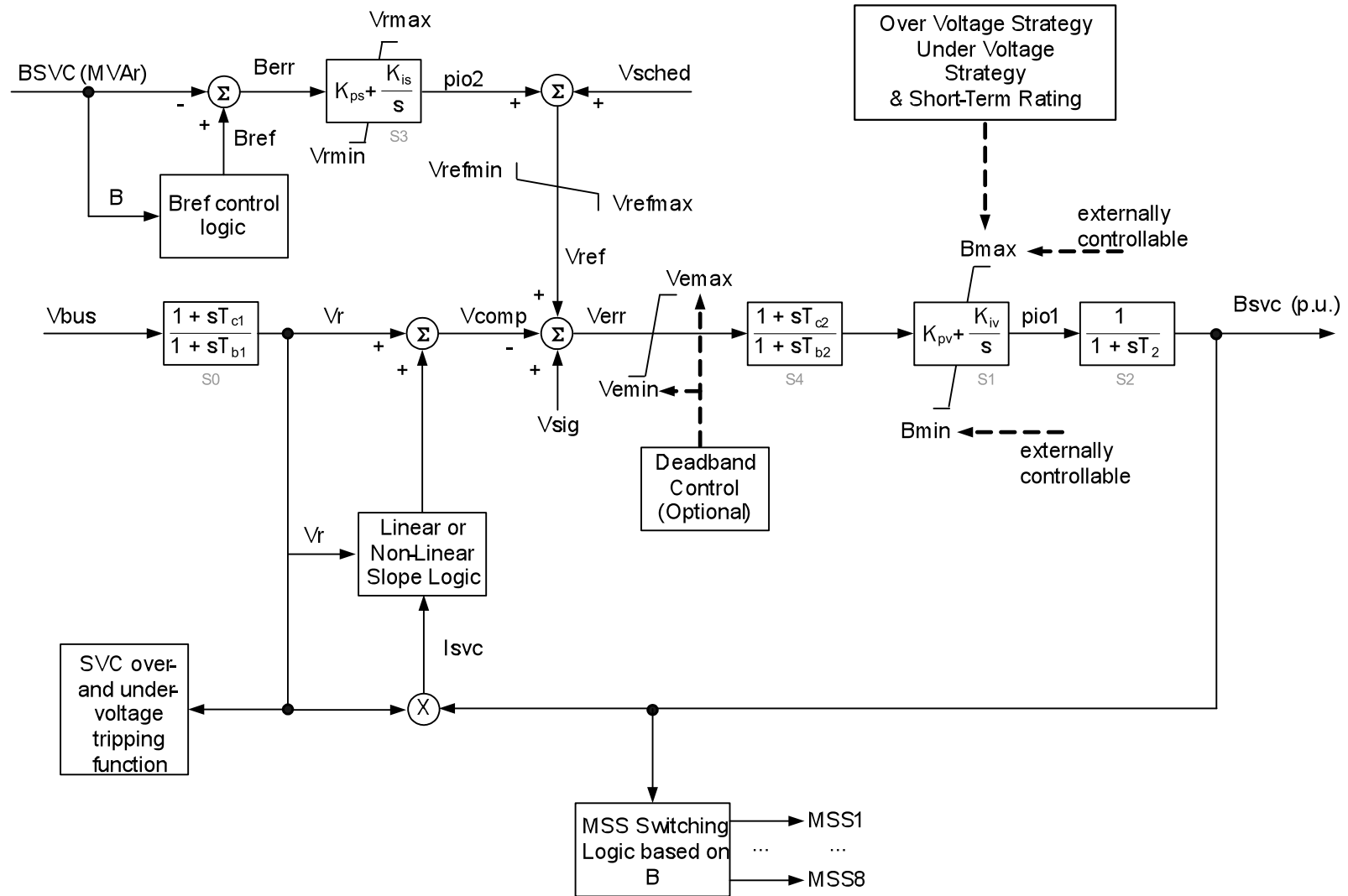

THE VALIDATION PROCESS



PMU RECORDINGS

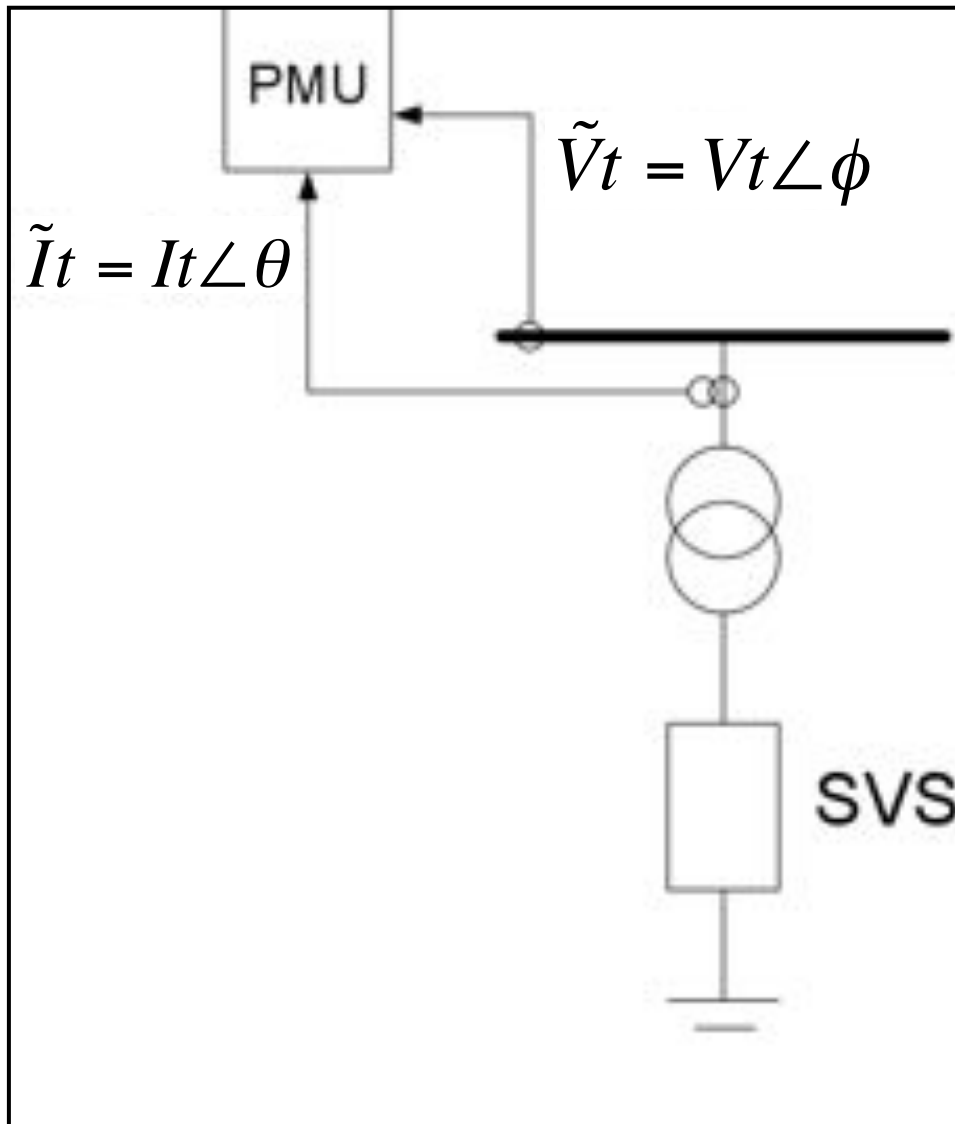

Calculating P, Q, I, and B

$$S = \sqrt{3} \times \tilde{V}_t \times \tilde{I}_t^*$$

$$P = \text{real}(S)$$

$$Q = \text{imag}(S)$$

$$\bar{V}_t = V_t / V_{nom}$$

$$I_{SVS} = Q / V_t$$

$$B_{SVS} = Q / V_t^2$$

TYPICAL EVENT RECORDINGS

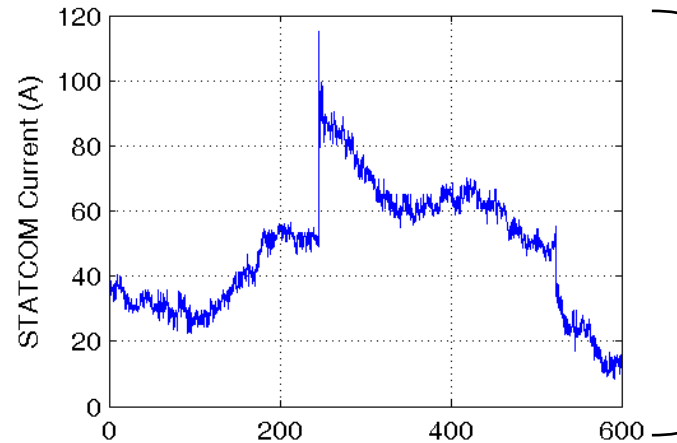
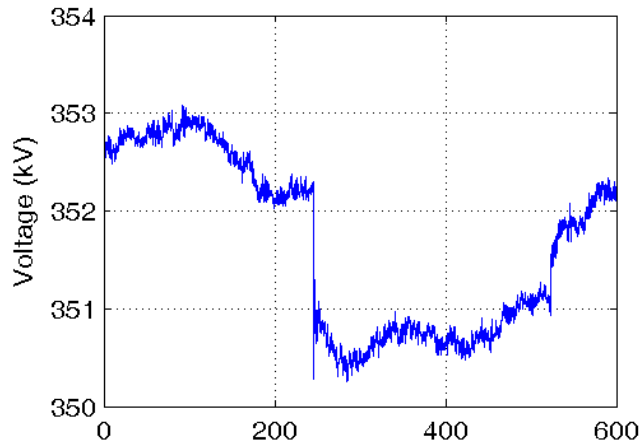

PMU

Losses
(neglected
in stability
simulations)

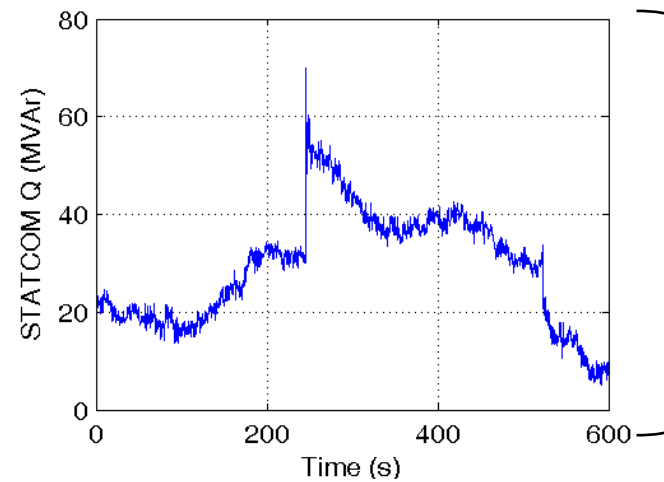
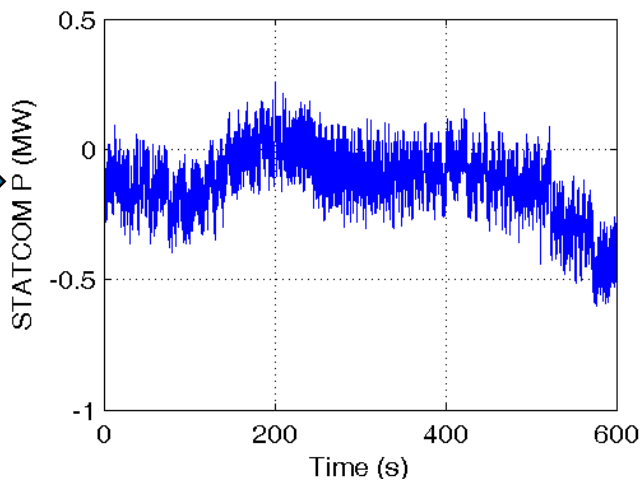

Calculated

THE VALIDATION PROCESS

- Take data recorded by the PMU during disturbance events
- Calculate from the PMU data the injected reactive current (or susceptance for SVC) and reactive power of SVS
- Choose the appropriate model for the device
- Play the measured voltage back into the model and fit the simulated reactive current I (or susceptance B) and Q to the measured values
- Optimize the gains of the controllers to get a good match via least squares estimation
- The optimization process is automated – this is done in a simple standalone software tool that was developed and is called Static Var System Model Validation (SVSMV) [3]

EXAMPLE VALIDATION RESULTS



MODEL VALIDATION – STATCOM Using SVSMO3 Model

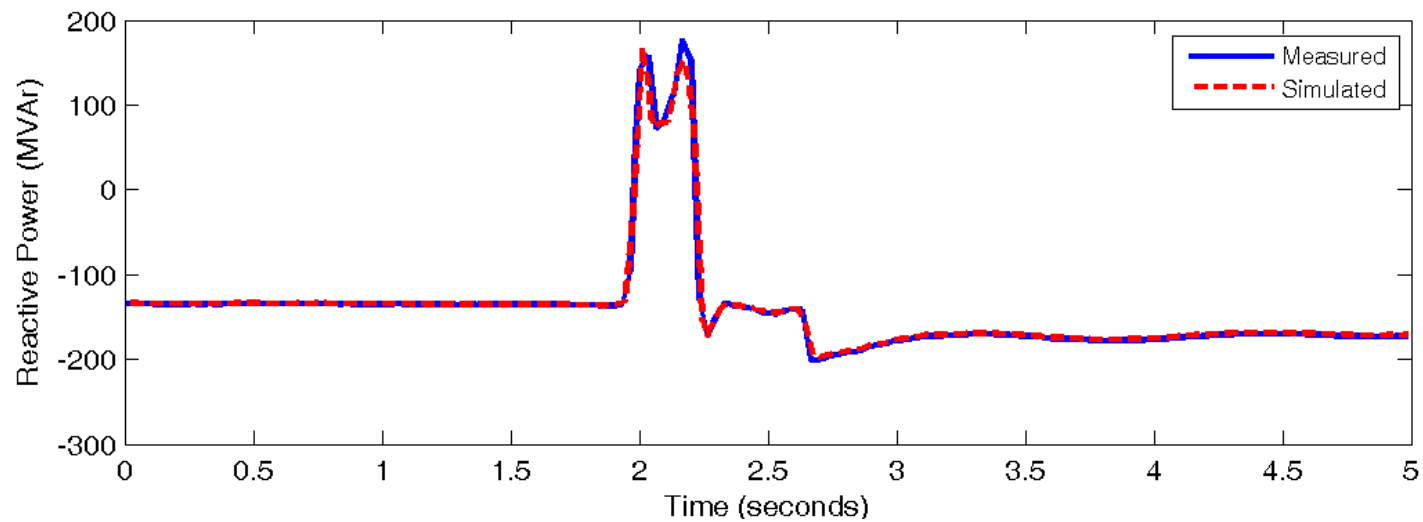
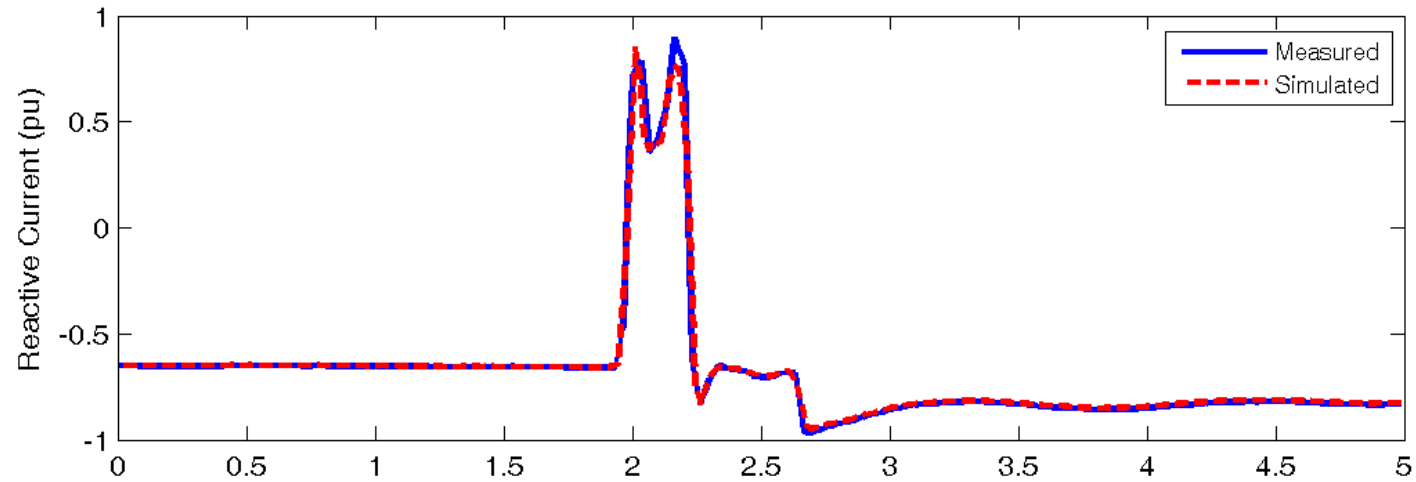

MODEL VALIDATION – STATCOM Using SVSMO3 Model

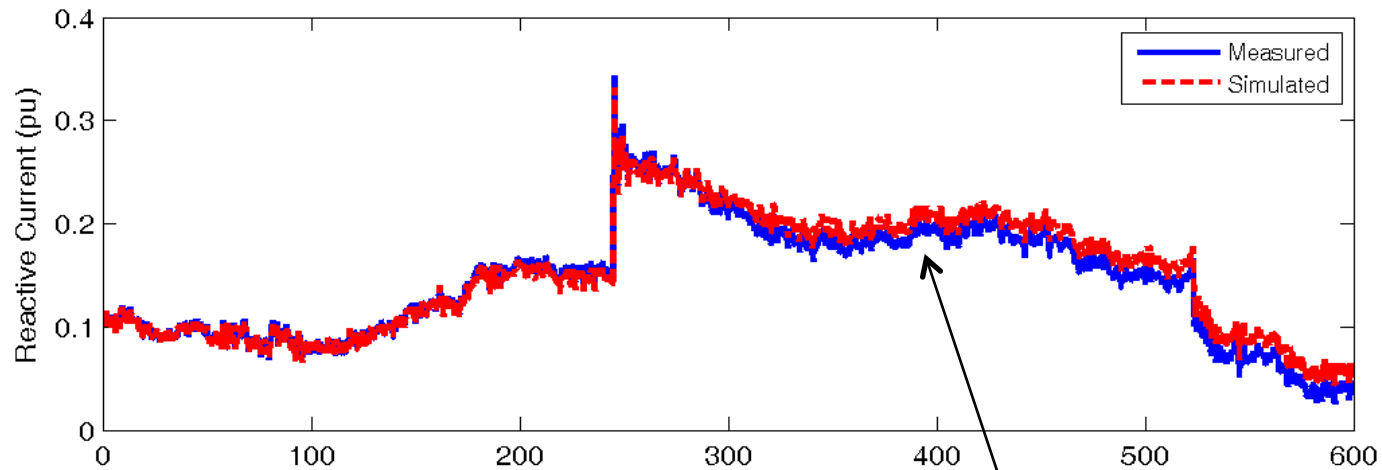

Action of slow-current regulator

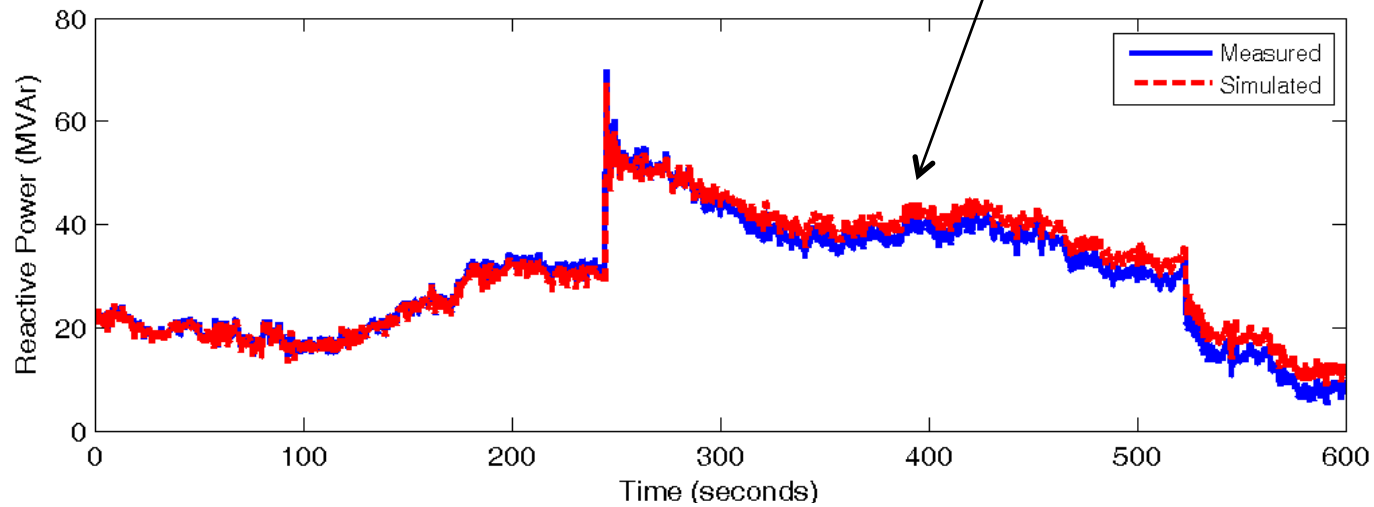

MODEL VALIDATION – SVC Using SVSMO1 Model

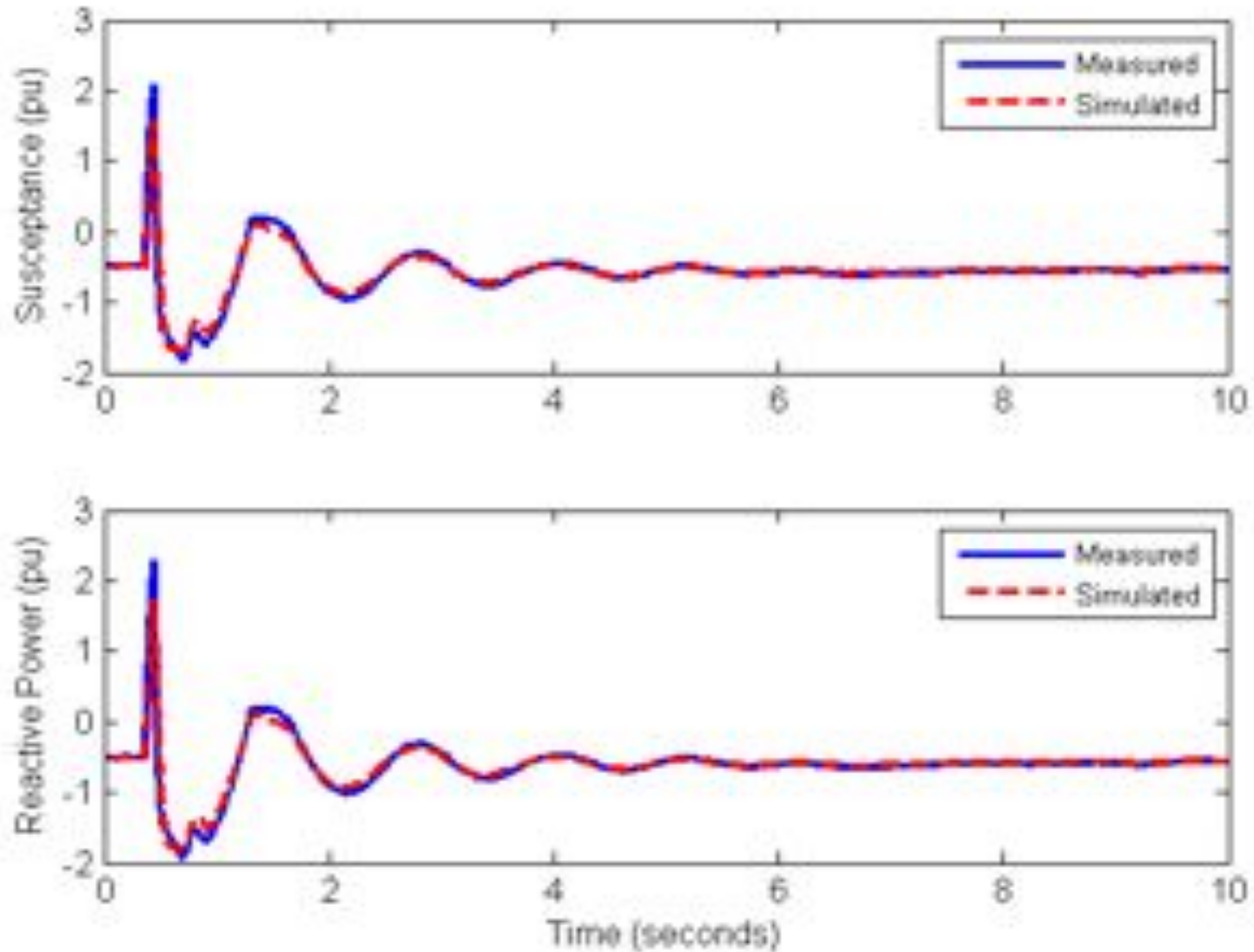

MODEL VALIDATION – SVC Using SVSMO1 Model

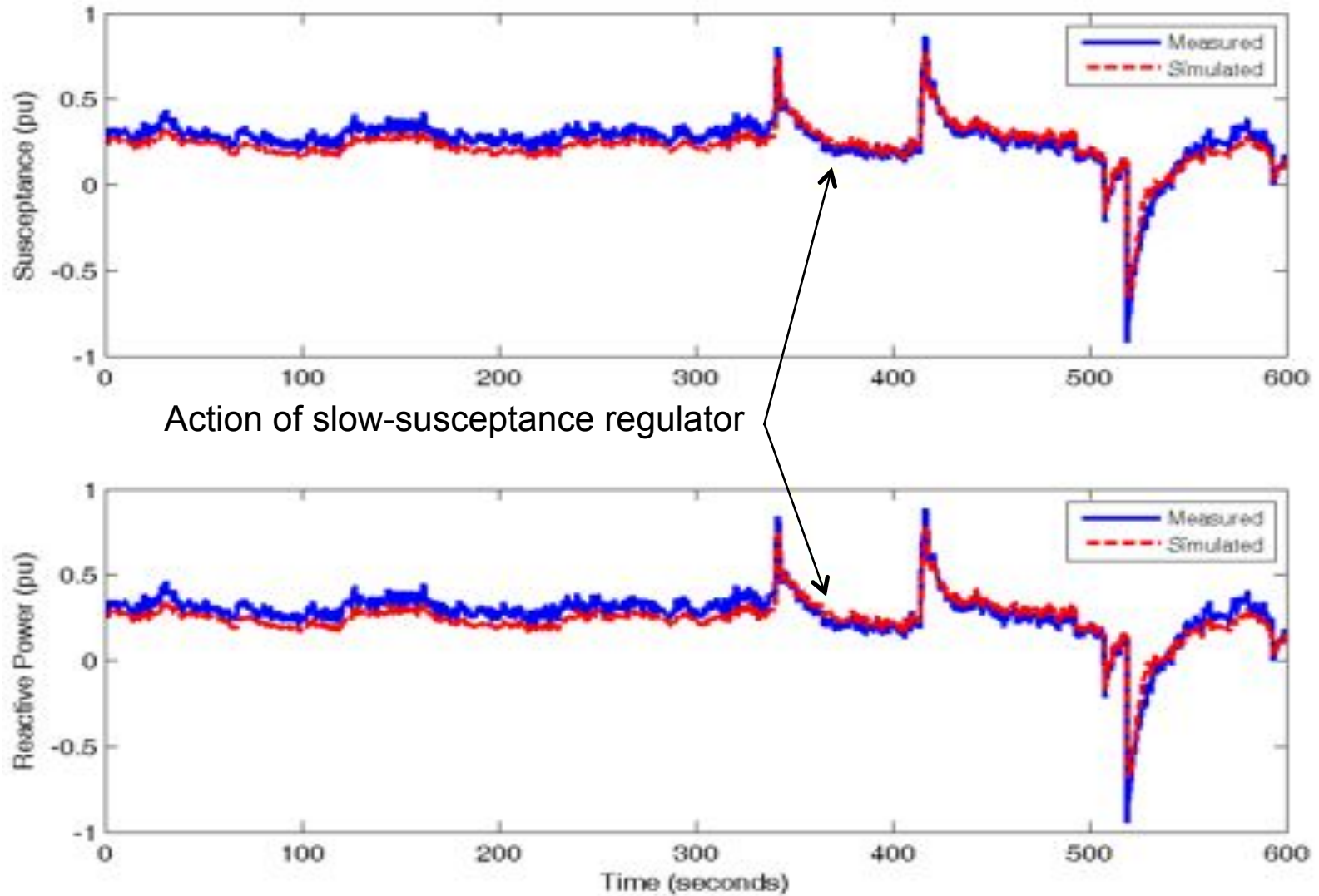

REFERENCES

[1] P. Pourbeik, D. Sullivan, A. Boström, J. Sanchez-Gasca, Y. Kazachkov, J. Kowalski, A. Salazar, A. Meyer, R. Lau, D. Davies and E. Allen, “Generic Model Structures for Simulating Static Var Systems in Power System Studies – A WECC Task Force Effort”, *IEEE Transactions on Power Systems*, August 2012.

[2] Generic Static Var System Models for the Western Electricity Coordinating Council, April 2011. <http://www.wecc.biz/committees/StandingCommittees/PCC/TSS/MVWG/SVCTF/Shared%20Documents/GenericStaticVarSystemModelsforWECC.pdf>

[3] *Static Var System Model Validation (SVSMV) Version 2.0*, June 2013, EPRI Product ID 3002001009. <http://www.epri.com/abstracts/Pages/ProductAbstract.aspx?ProductId=000000003002001009>



Together...Shaping the Future of Electricity

Pouyan Pourbeik
Technical Executive
Electric Power Research Institute
ppourbeik@epri.com
www.epri.com

George Stefopoulos
Research and Technology Development Engineer I
New York Power Authority
george.stefopoulos@nypa.gov
www.nypa.gov

ISO-NE's Model Validation of HVDC and Nuclear Unit using Synchrophasor Data



NASPI Model Validation Workshop

Xiaochuan Luo

TECHNICAL MANAGER



Outline

- ISO-NE's Synchrophasor Infrastructure and Data Utilization (SIDU) Project
- Pilot On-line Transient Stability Assessment
- Model Validation of HVDC
- Model Validation of Nuclear Unit
- Conclusion and future plans



ISO-NE's Synchrophasor Infrastructure and Data Utilization (SIDU)

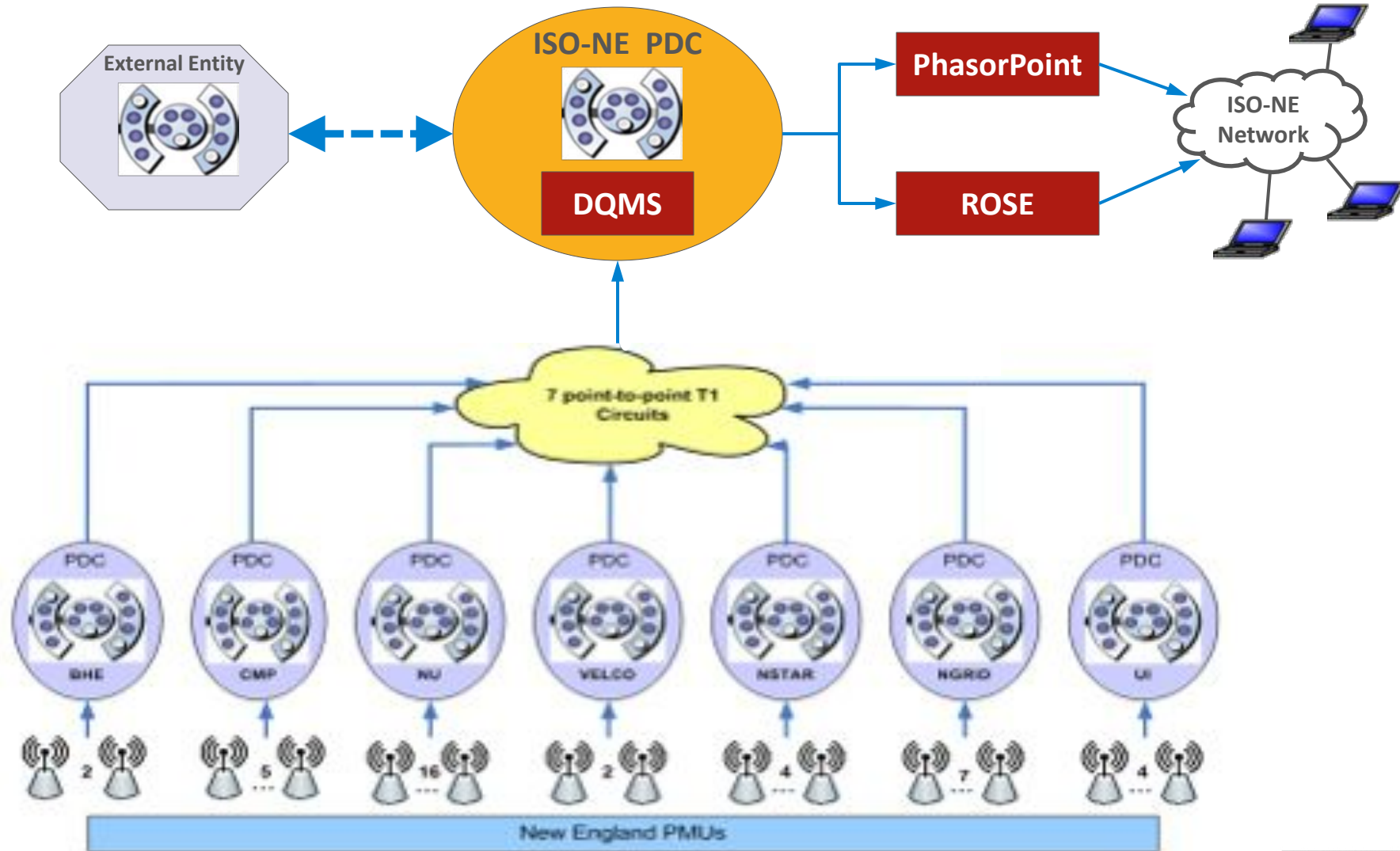

Pilot On-Line Transient Stability Assessment

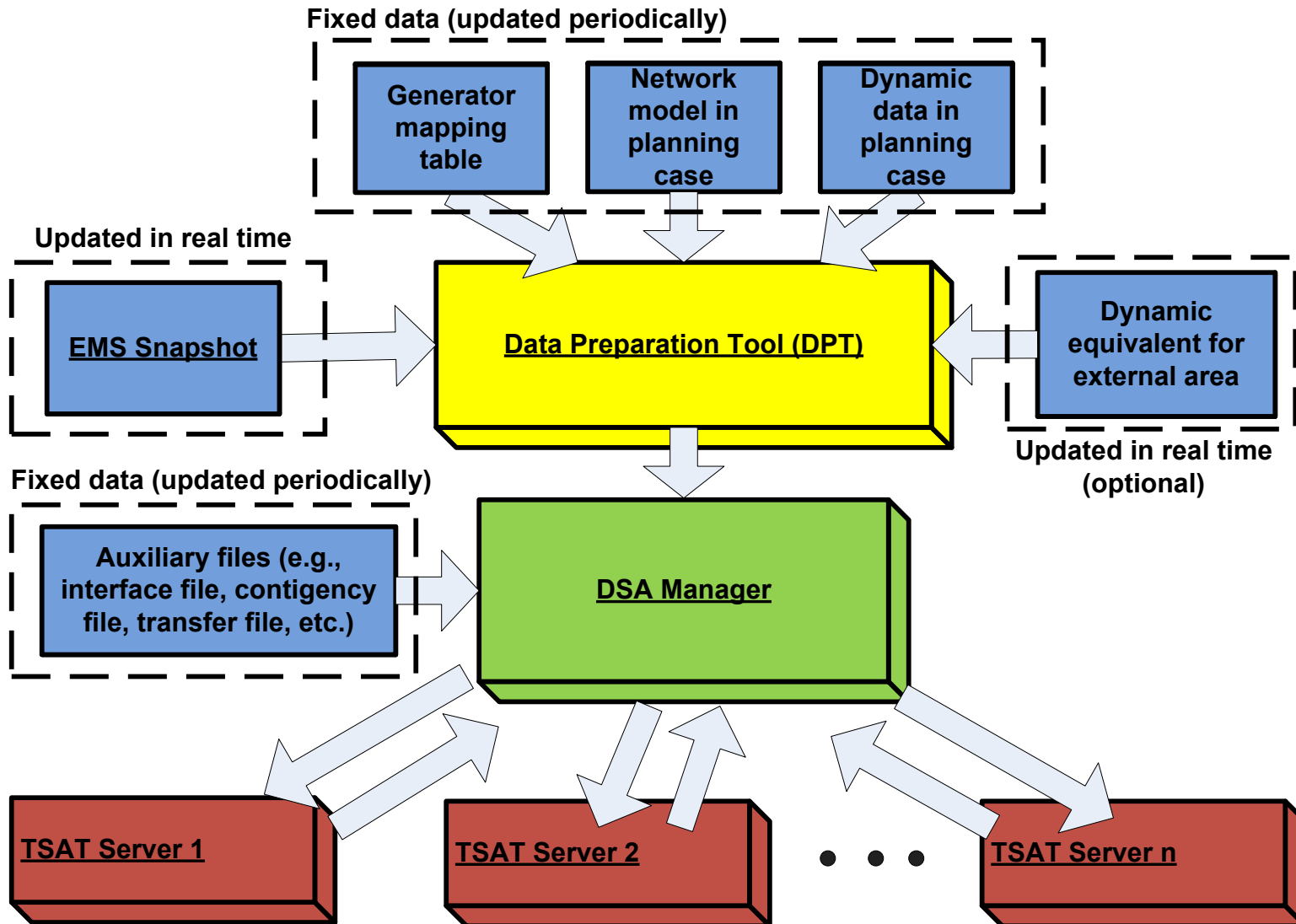

Validation of HVDC Model

- Single phase-to-ground fault occurred at 18.2% of line 337 from SANDY POND station
- Fault was cleared after 5 cycles by opening line 337

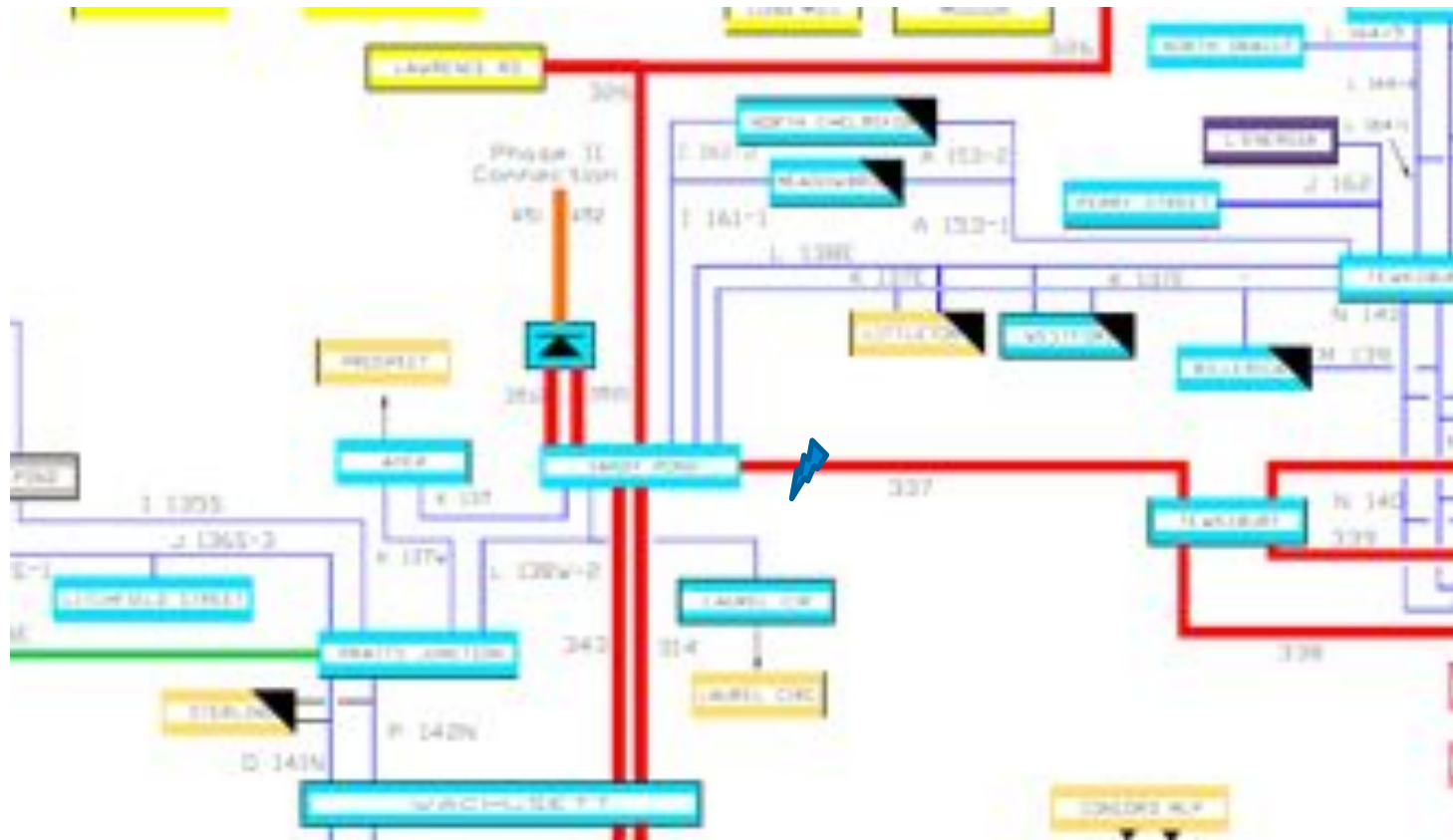

Validation of HVDC Model

Sandy Pond 345 kV Voltage - PMU

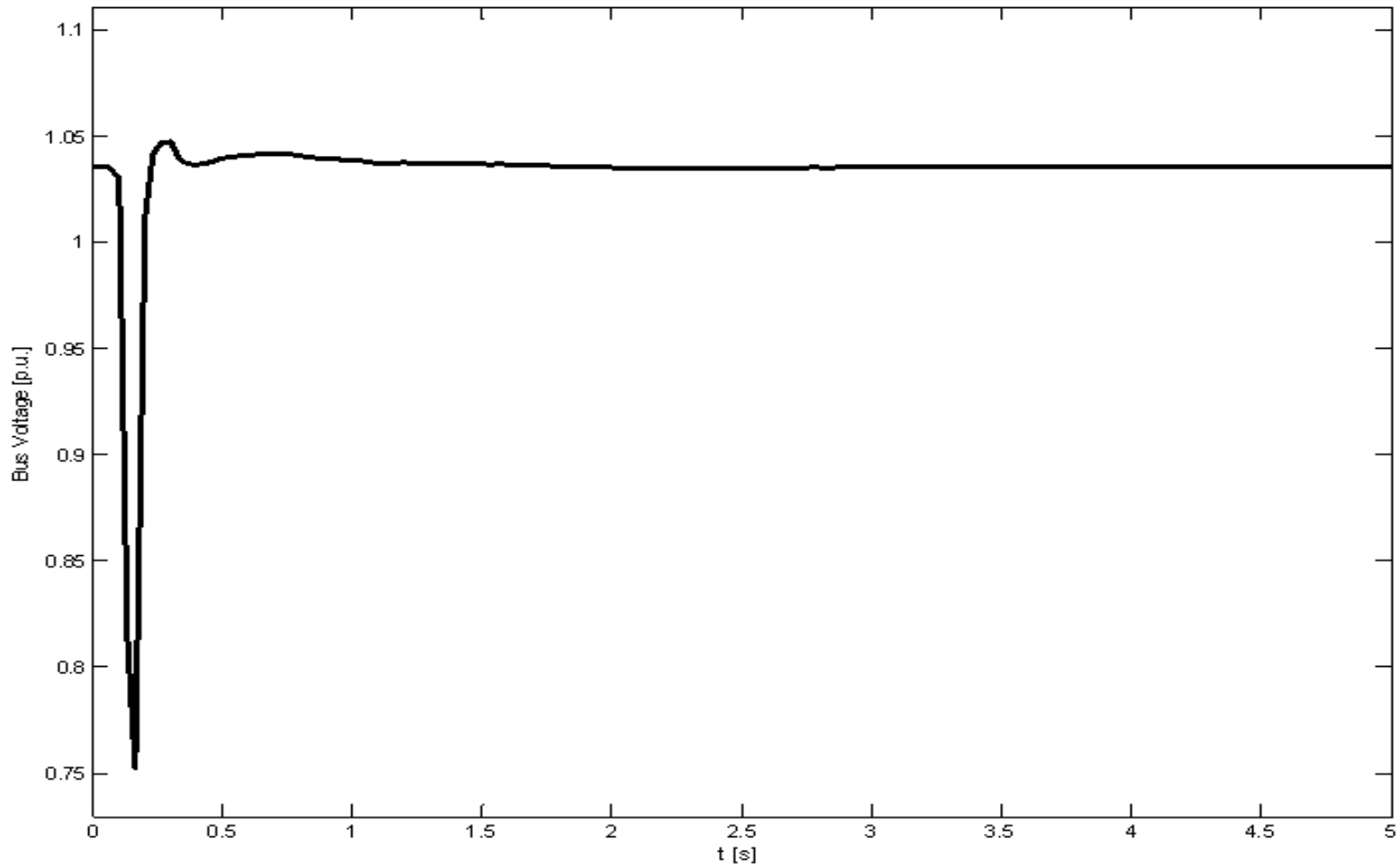

Validation of HVDC Model

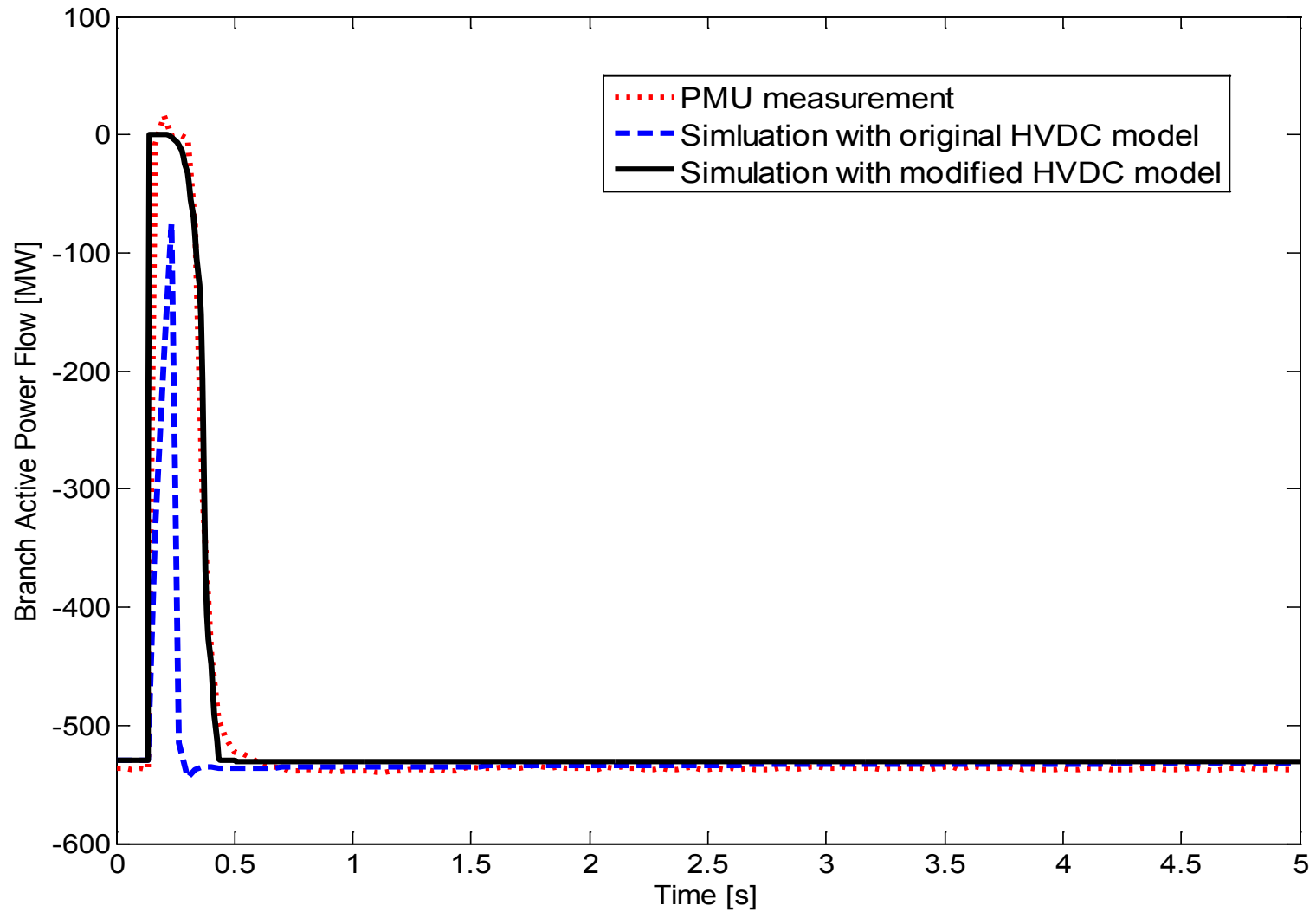

Validation of Nuclear Unit

- Phase B to ground fault on line 348, 16 miles away from the MILLSTONE station
- Fault was cleared after 5 cycles by opening line 348; Line was reclosed after 10.5 seconds

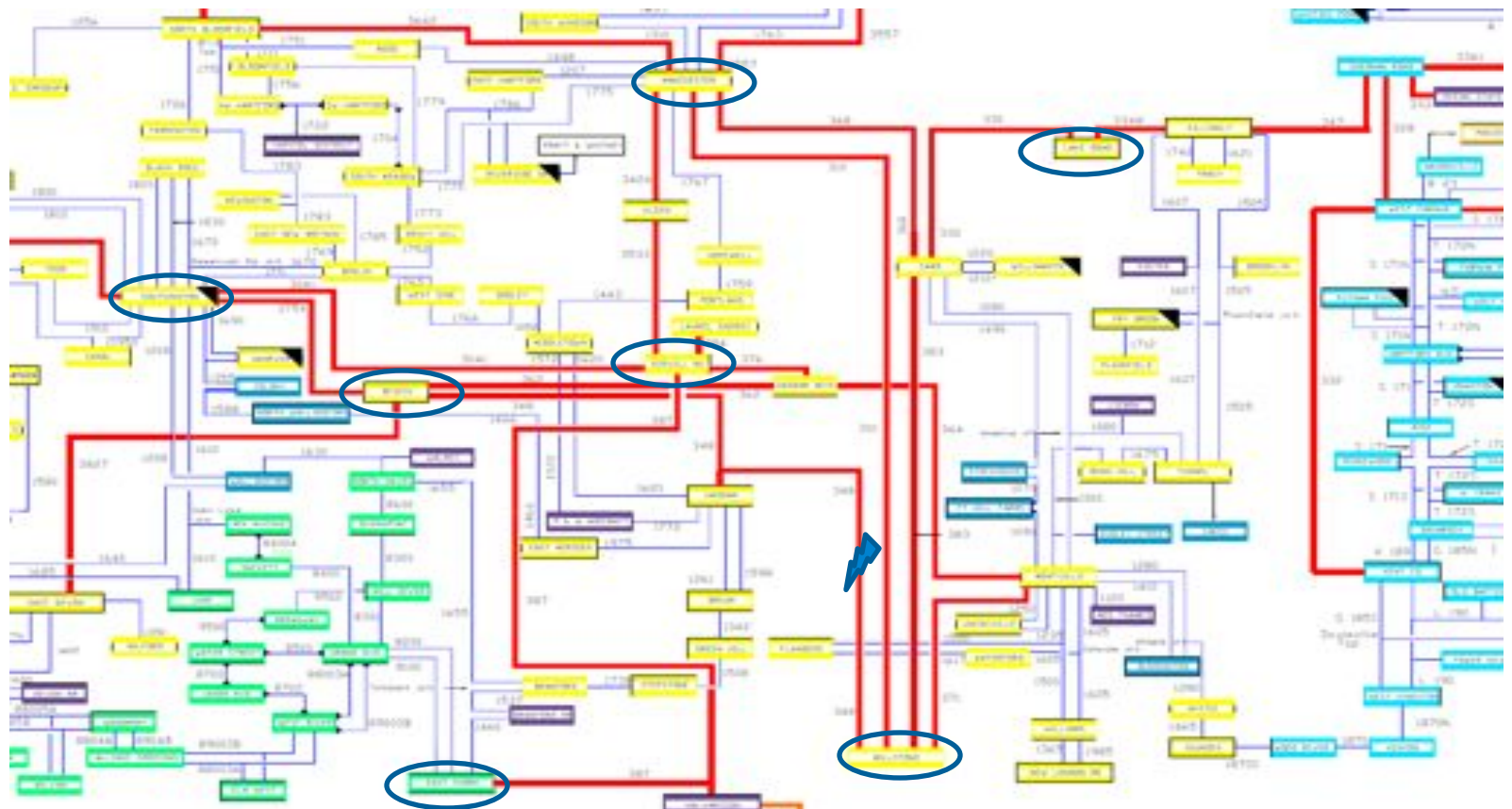

Millstone 345 kV Voltage

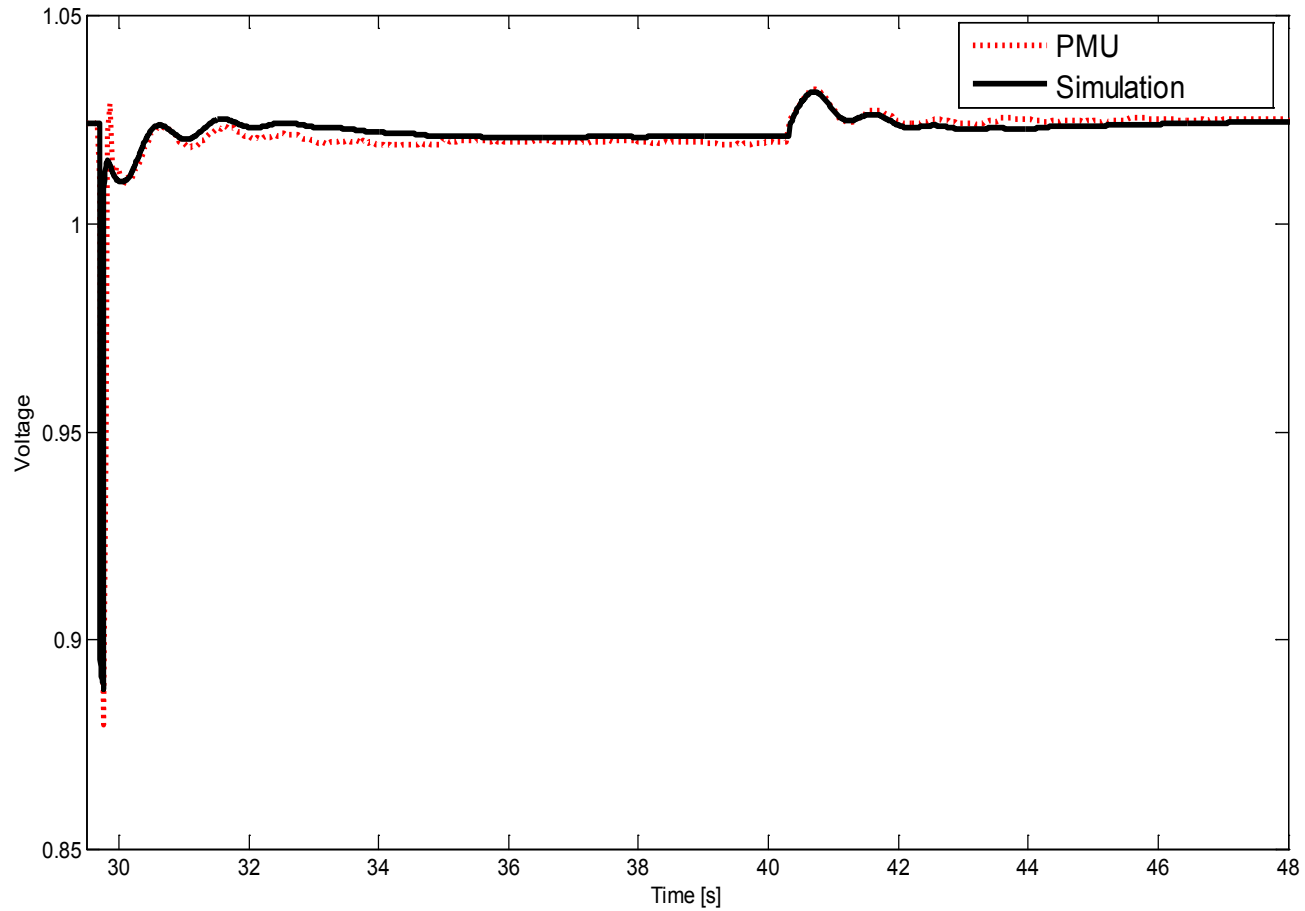

Line 310 Active Power (Millstone – Manchester)

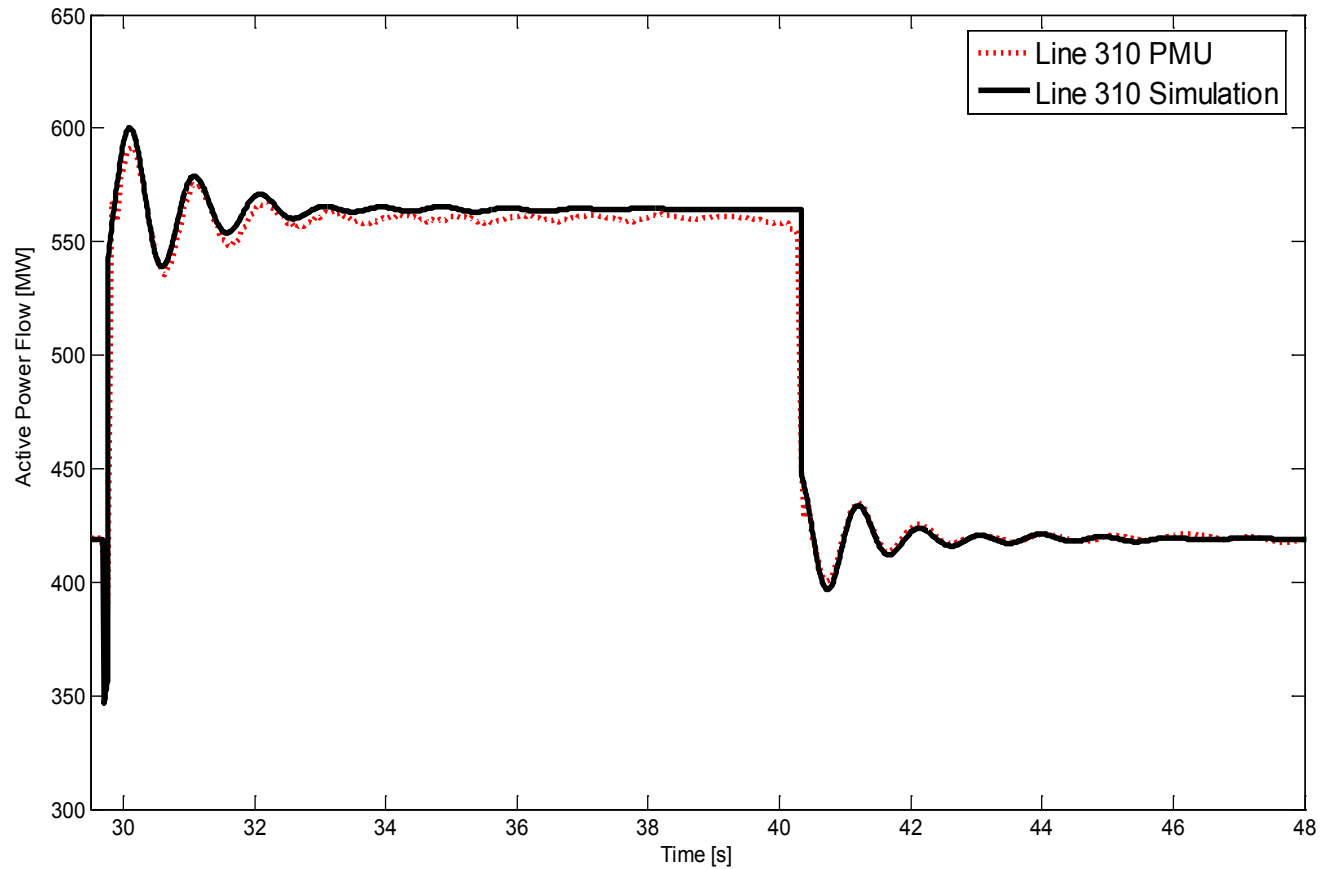

Line 368 Active Power (Manchester – Card)

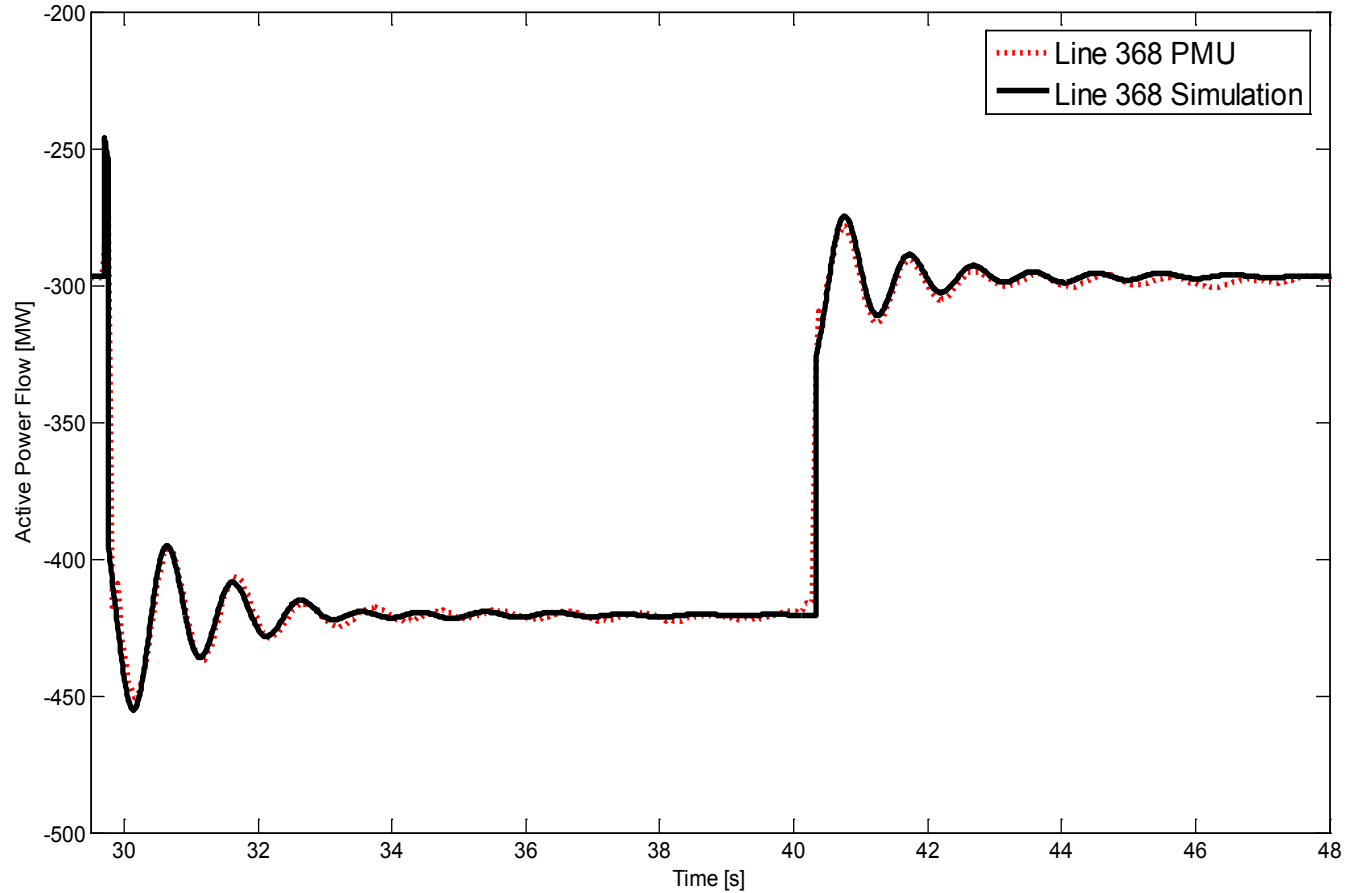

Millstone Unit 3 Active Power

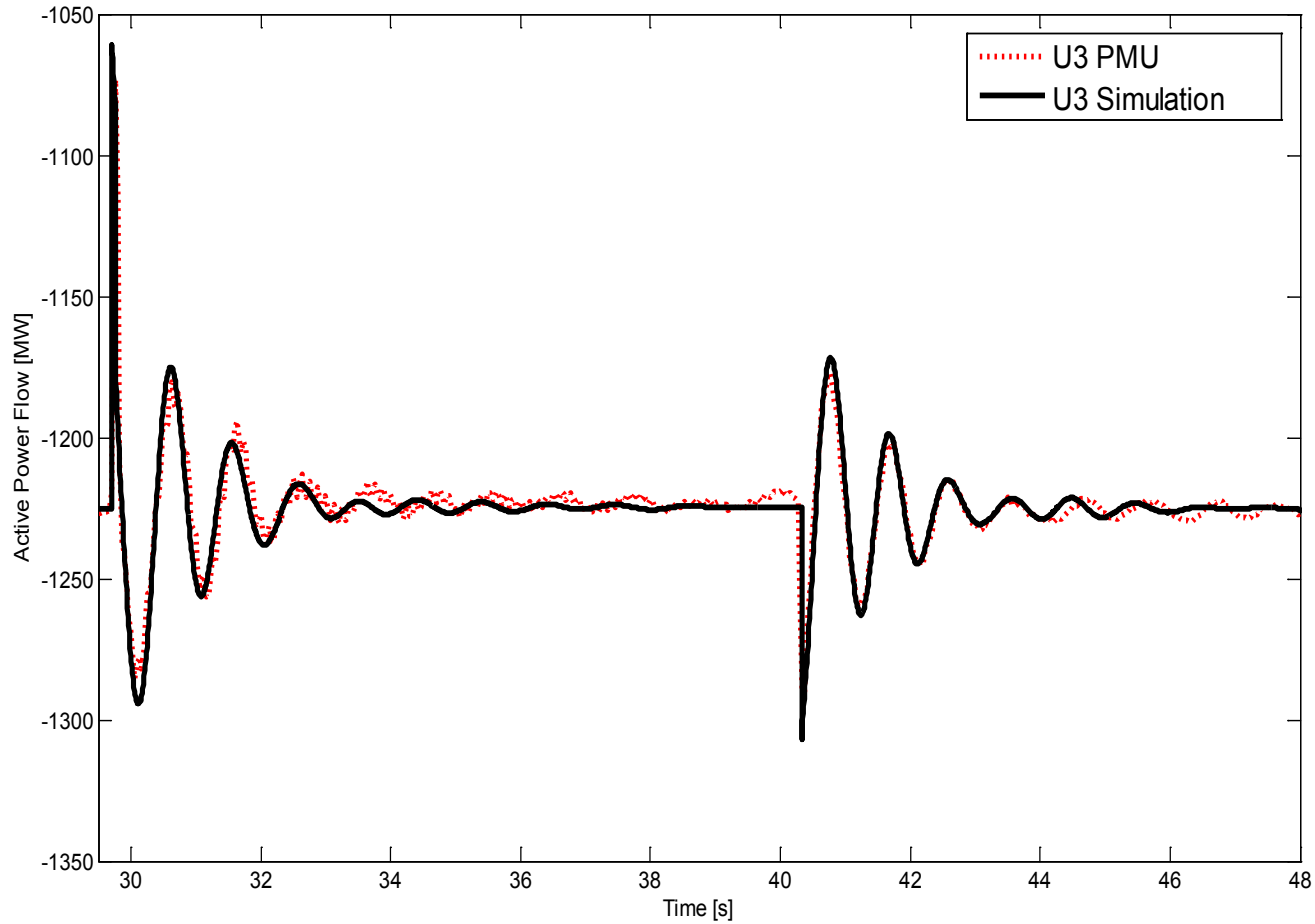

Millstone Unit 2 Active Power

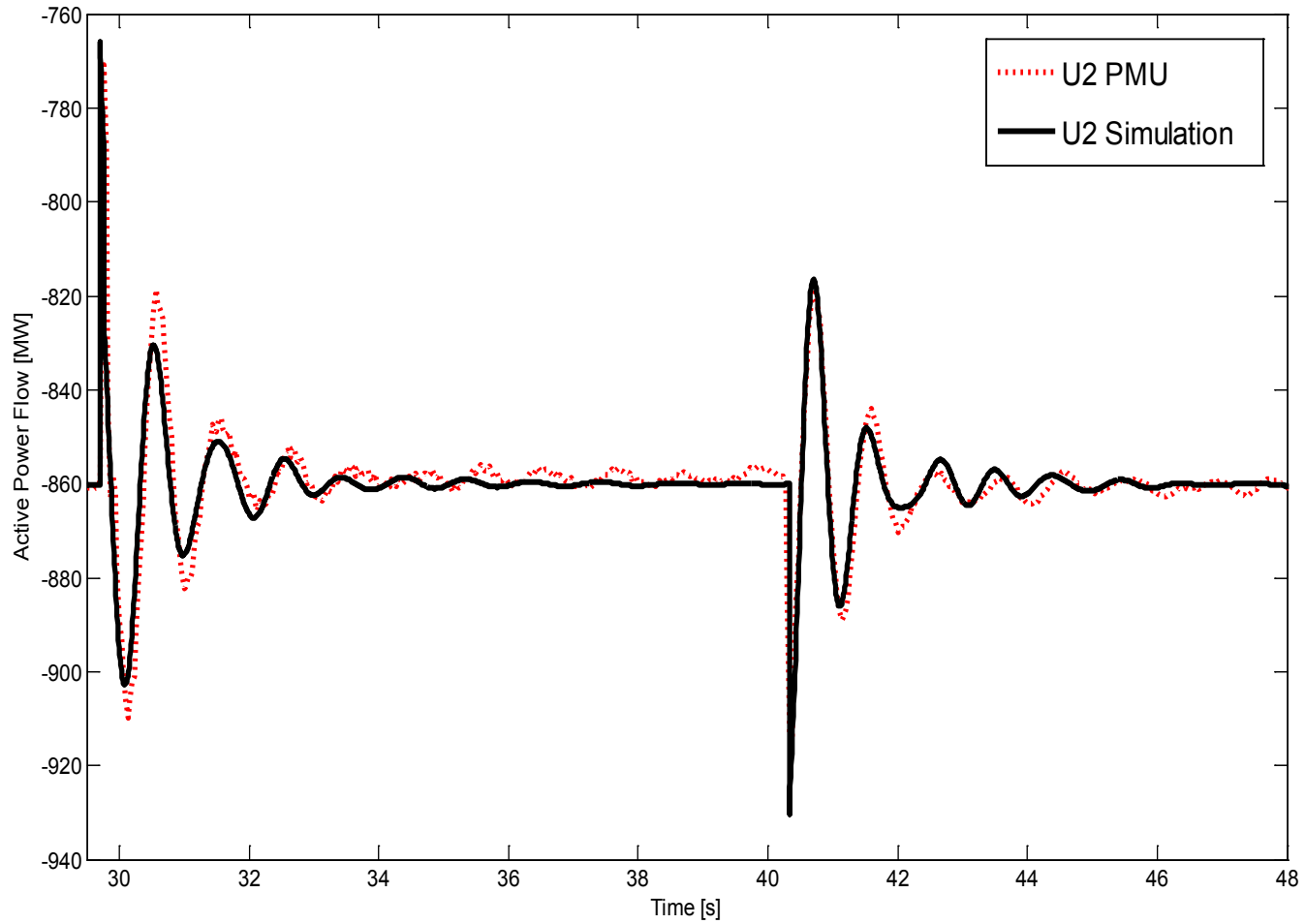

Conclusion and Future Plans

- The synchrophasor system and On-line Transient Stability Assessment build the foundation for dynamic model validations
- Develop the process and tools to automate certain parts of the dynamic model validation
 - NERC MOD-B that ISO must “validate” system models with actual disturbance events
- Access DFR and DDR data from Transmission Owners
 - Historian/database to support storing different types of time tagged data
- Continue the exercise of dynamic model validation for generators, HVDCs, load, SVC, etc

Questions





Use of Synchronized Phasor Measurement for Model Validation

Bill Blevins

Manager

ERCOT Operations Planning

NASPI Meeting

October 22 2013

Overview of the ERCOT System

ERCOT Capacity and Demand

- **One of the largest single control areas in US**
 - 40,530 miles of transmission (345kV & 138kV)
 - 85% of Texas load
- **Capacity**
 - 84,000 MW total capacity
 - Wind capacity: over 10 GW – most in nation
- **All-time Peak Demand**
 - 68,379 MW peak load (Aug.3, 2011)
- **Market Size**
 - 23 million consumers
 - \$ 34 Billion Market

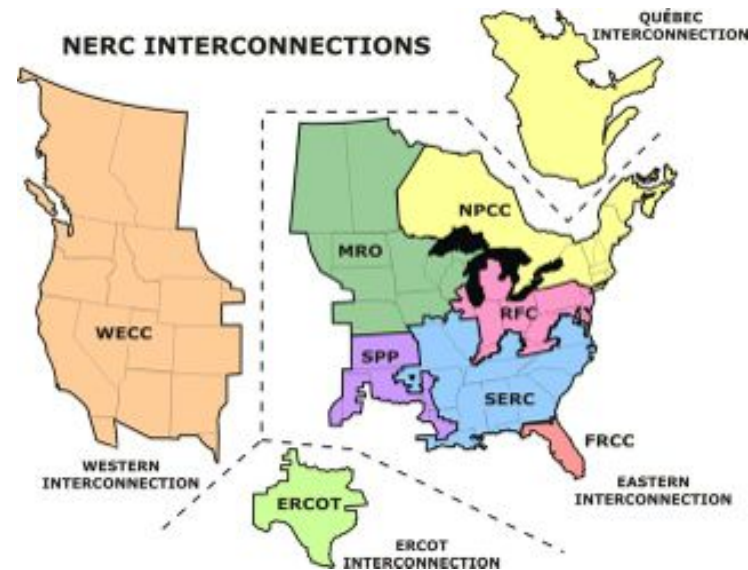

The ERCOT Synchrophasor (PMU) Project

- Started as a pilot project in 2008
- A collaborative effort including:
 - ERCOT
 - Transmission companies: ONCOR, AEP, Sharyland
 - Software vendor: EPG
 - Project coordinator: CCET
 - University: UT-Arlington

The Synchrophasor Data Communication Network

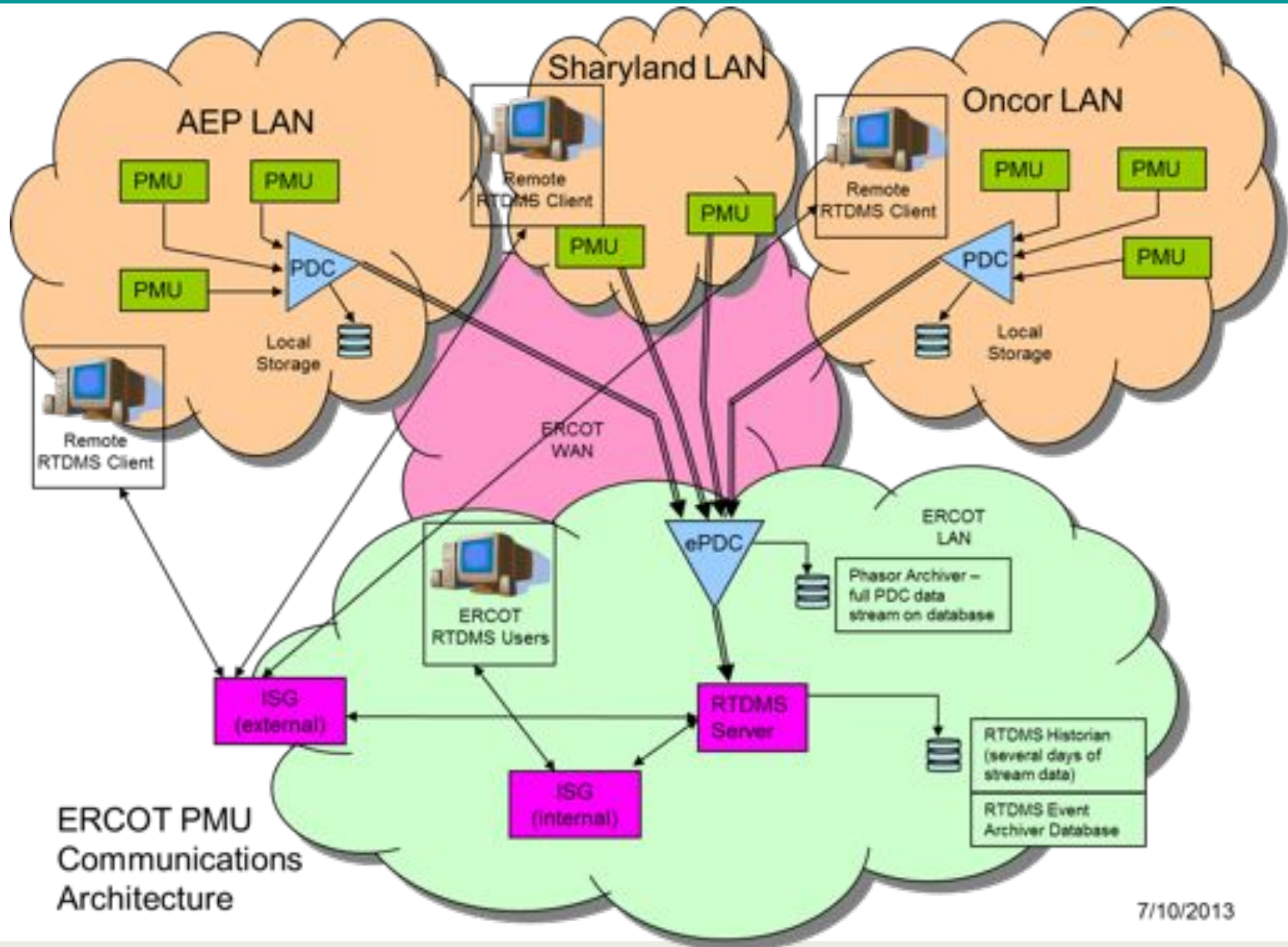

ERCOT PMU Communications Architecture

7/10/2013

Applications of Synchrophasor Data

- Phasor measurement data has been used in ERCOT system for three purposes:
 - Post-event analysis
 - Real time system monitoring
 - Generator model validation

Generator Model Validation

- Both operations and planning engineers rely on dynamic simulation tools to study the behavior of the power system and identify the stability issues in the grid.
- The accuracy of the dynamic models is the key to achieve correct and reliable study results.
- Electric Device (IED) such as DFRs and PMUs can provide dynamic information with high resolution, which makes online dynamic parameter identification become valid option.

Generator Model Validation – Advantages of PMUs

- Provide additional high accuracy measurements for comparison against simulation
- Enable model verification of online events that may not be observable in off-line field testing
- Reduce model complexity by allowing model components to be replaced with a data driven component

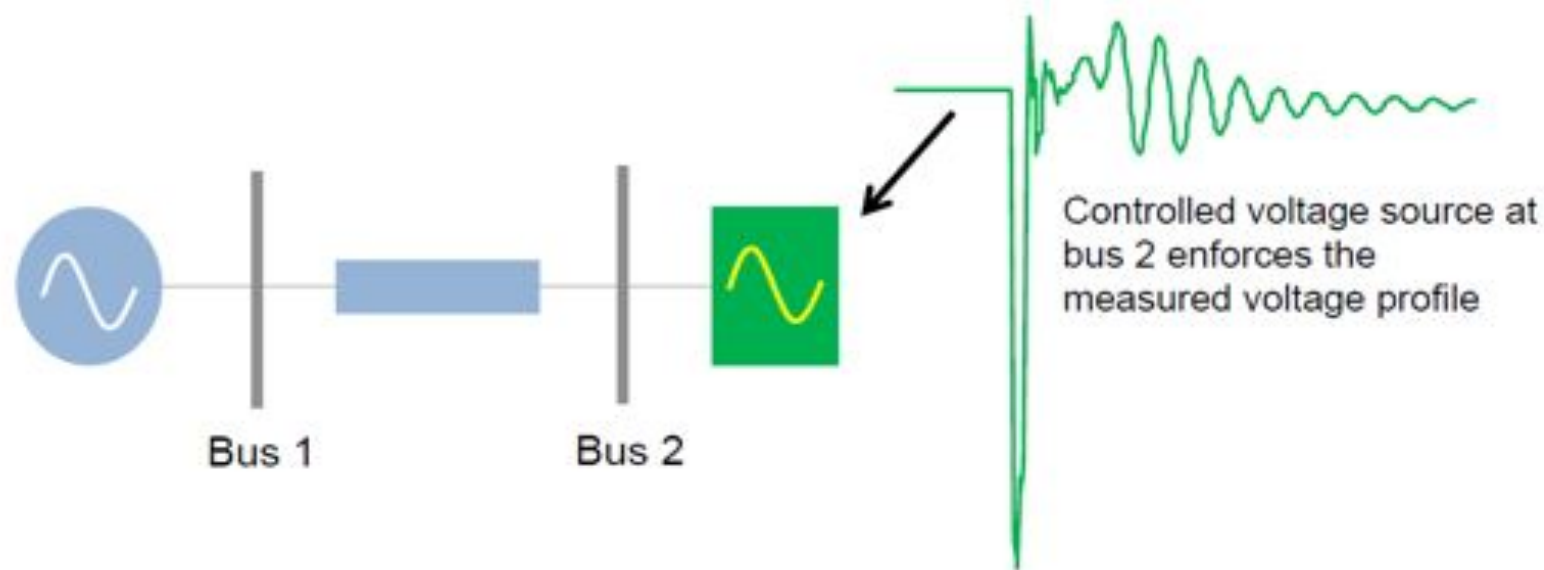

Example: Use PMU Data to tune a Wind Model

- Simplified network topology of the wind power plant

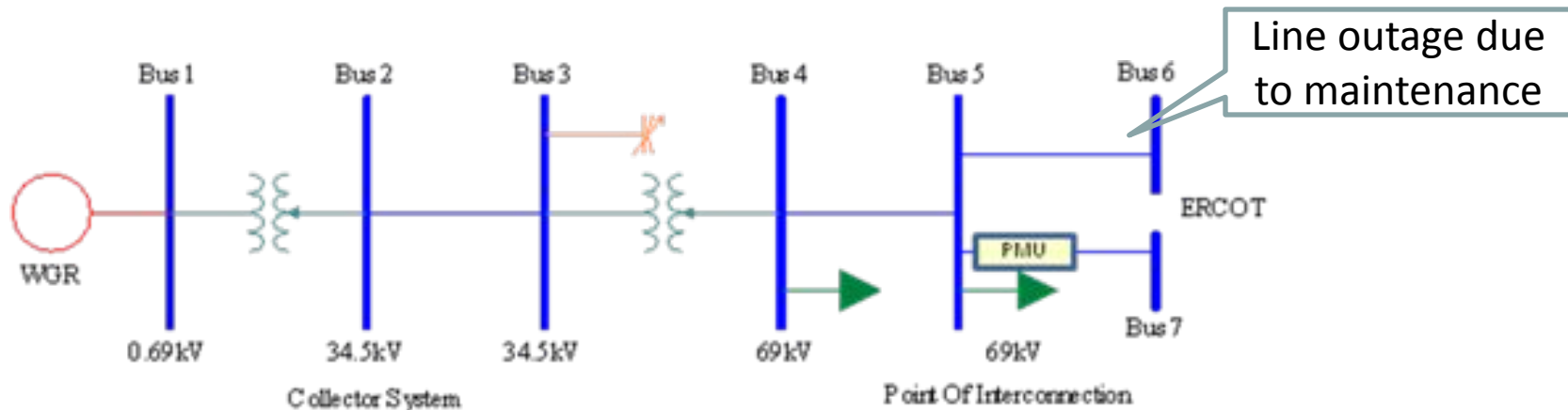

Example: Use PMU Data to tune a Wind Model

- Voltage oscillations observed at the PMU
 - Poor-damped oscillation at low output
 - Un-damped Oscillation at high output

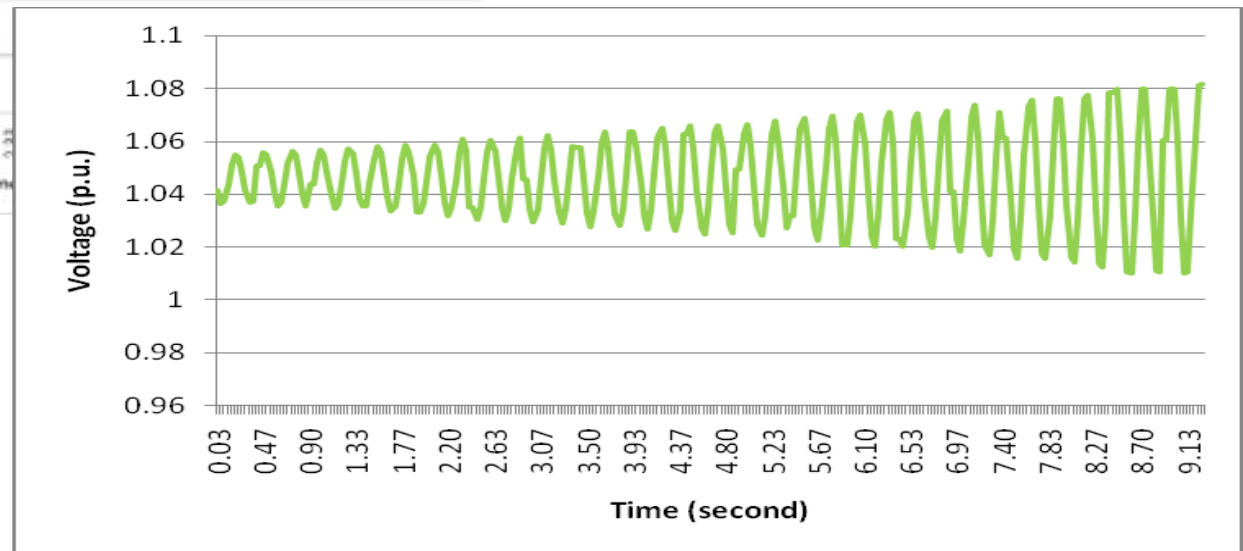
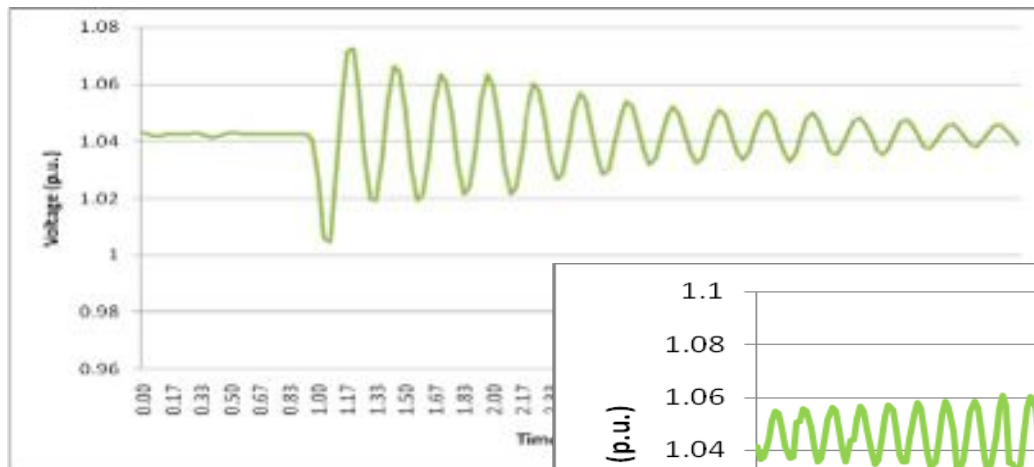

Example: Use PMU Data to tune a Wind Model

- Post Event Analysis
 - Re-create the oscillations as captured by the PMU using simulation tools such as MATLAB and Powertech Tools
 - Identify the cause and solutions to mitigate the oscillations
- Benchmarking of tuned model using PMU data –

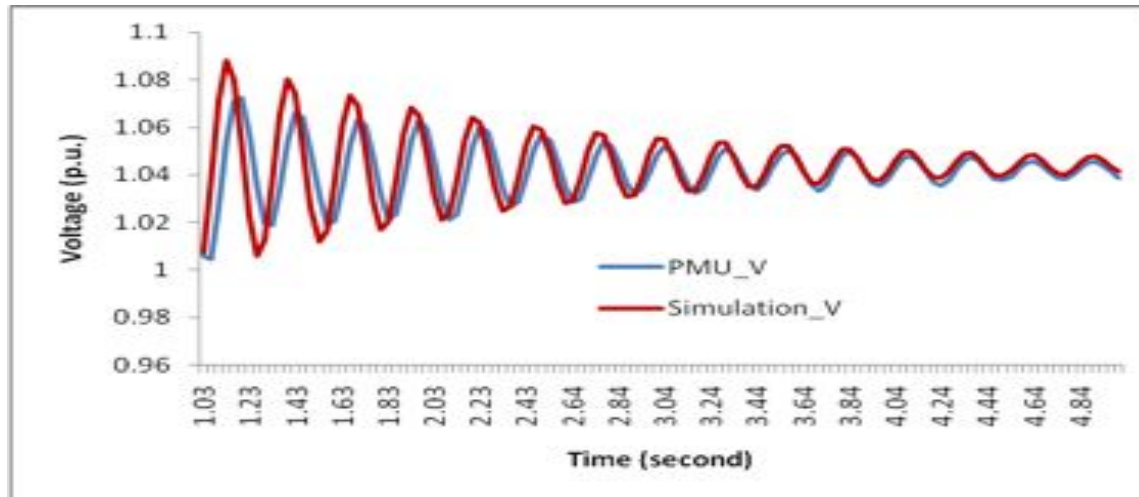

Generator Model Validation

NERC Regulation (MOD 26/27) Generator/Exciter Modeling & Validation

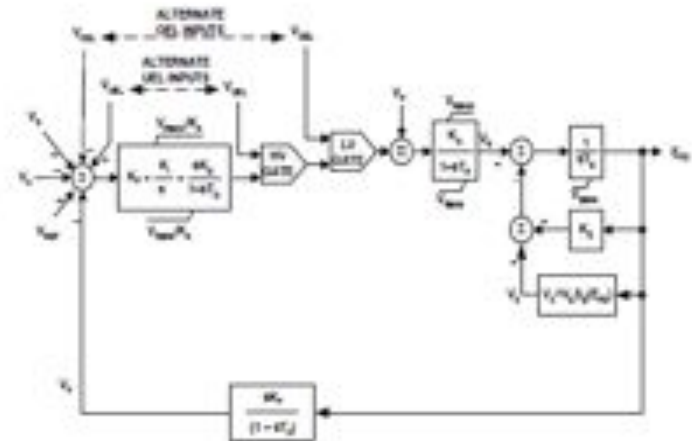
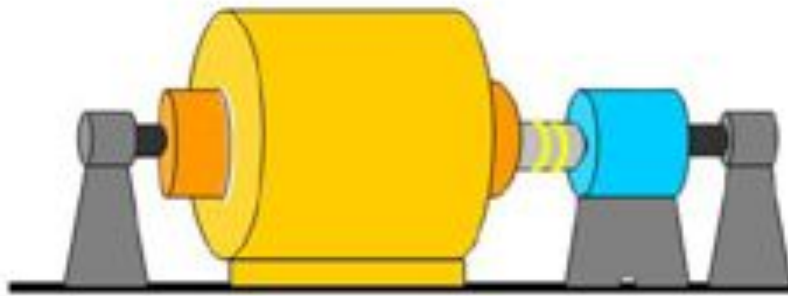

Challenge: Build a good dynamic model for a Generator/Excitation System that matches the actual equipment in the field and validate it through offline/online testing

Example: Use PMU Data to tune a Wind Model

- Representation of the wind farm (generic equivalent model) and the simplified topology in MATLAB/Simulink framework

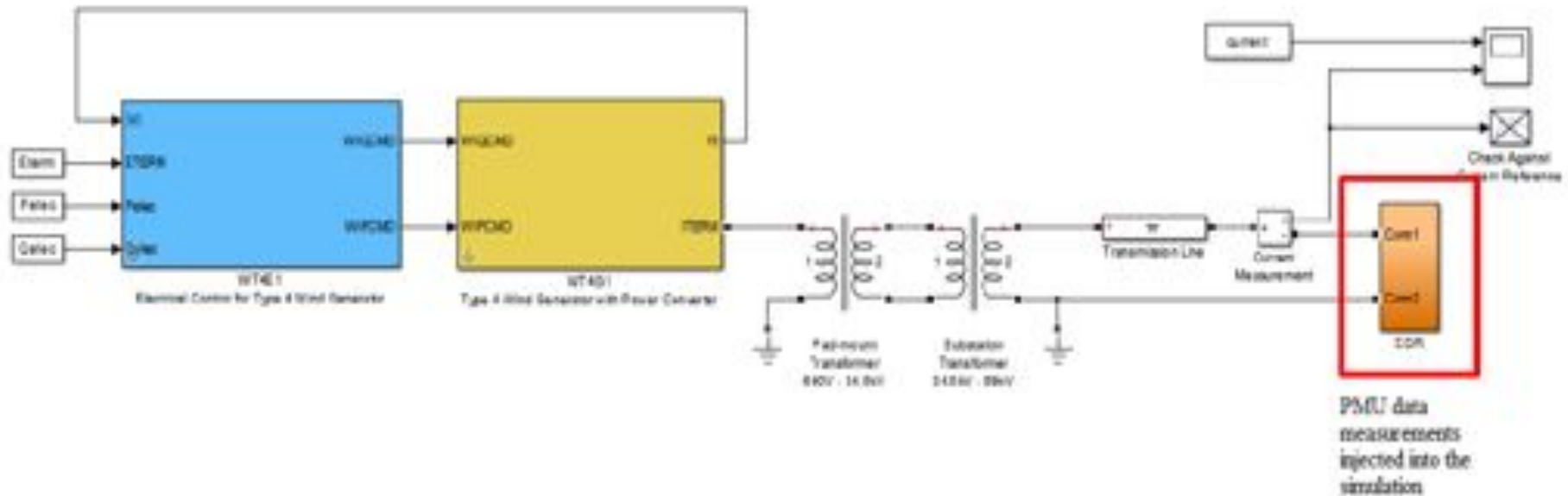

Example: Use PMU Data to tune a Wind Model

- Proposed solution based on simulation studies

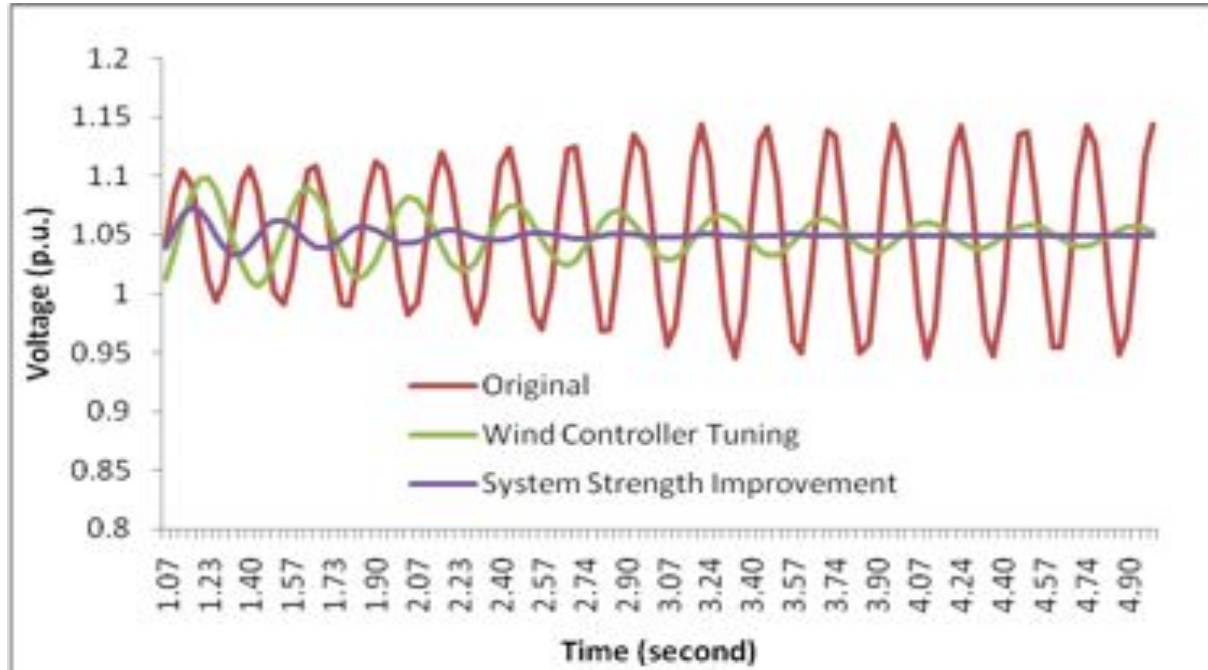

Conclusions

- Synchrophasor measurements allow for parameter estimation and verification of generator models.
- Reduction of system models to a time-series data component greatly simplifies the process.
 - Possibility of online parameter estimation and verification
- Automation of the process using software tools like MATLAB greatly eases the workload associated with matching simulation models with measured response.



Q&A



Model Re-Validation/Invalidation and Calibration using PMU Disturbance Data

Bernie Lesieutre



Use PMU Disturbance Data

1. Use disturbance data to evaluate modes:
 - Affirm models
 - Refute models
2. Recalibrate models
3. Identify structural changes



Affirm/Refute/Calibrate

Compare Data and Simulations

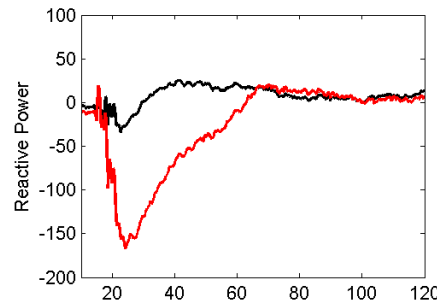
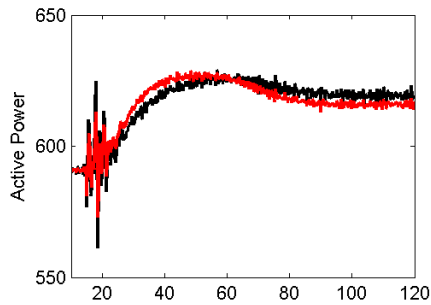

Refute Model

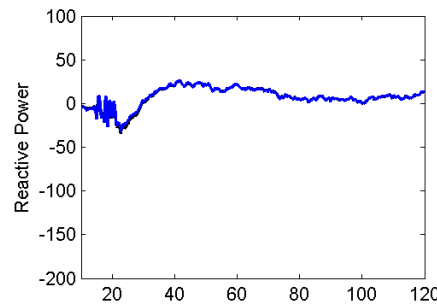
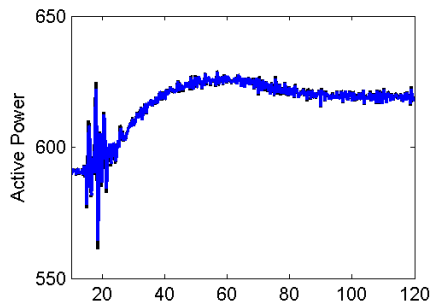

Recalibrate Model



Recalibration

We use a sensitivity model to represent changes in model parameters to outcomes of the simulations – trajectories and other features of interest.

We calculate the sensitivity model using perturbation analysis from repeated PSLF simulations.



Sensitivity Models

We rely on models to analyze the grid under various conditions - actual and anticipatory.

Sensitivity models relate features of model-based analyses, to model properties. This is useful for

- Understanding the model components
- **Tuning and improving models based on observations**
- Estimating the range of possible outcomes, i.e., map model uncertainties to responses.



Model Tuning

We've calculated sensitivity models to help

- Estimate load model parameters,
 - System wide simulations
 - Load models for FIDVR studies
- Estimate power plant parameters from PMU measurements



Sensitivities for Model Tuning

Example of using PMU data to fit observations

Before

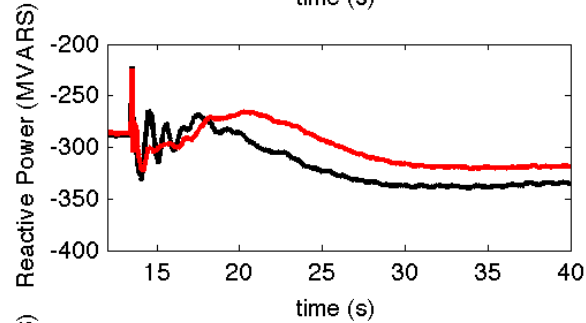
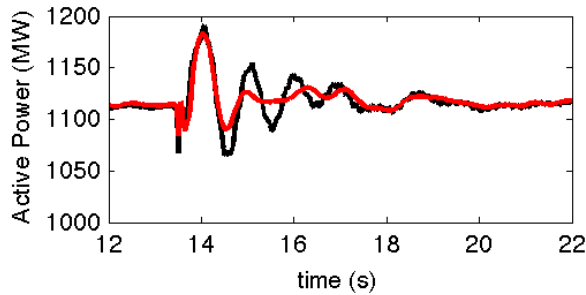
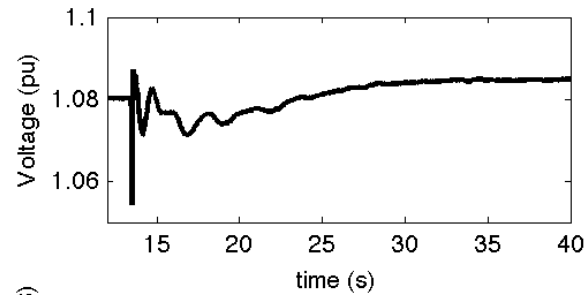
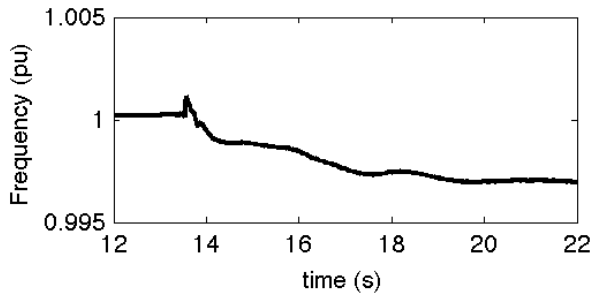

After

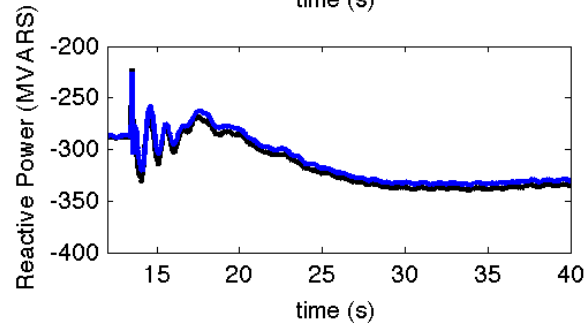
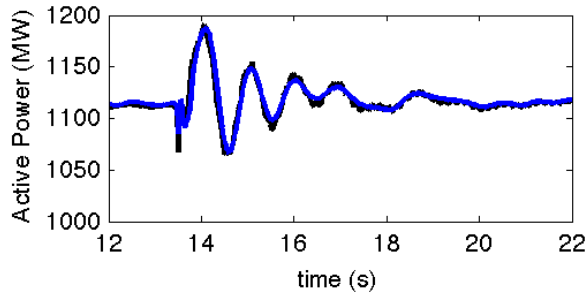



Sensitivities for Model Tuning

Example of some parameter adjustments

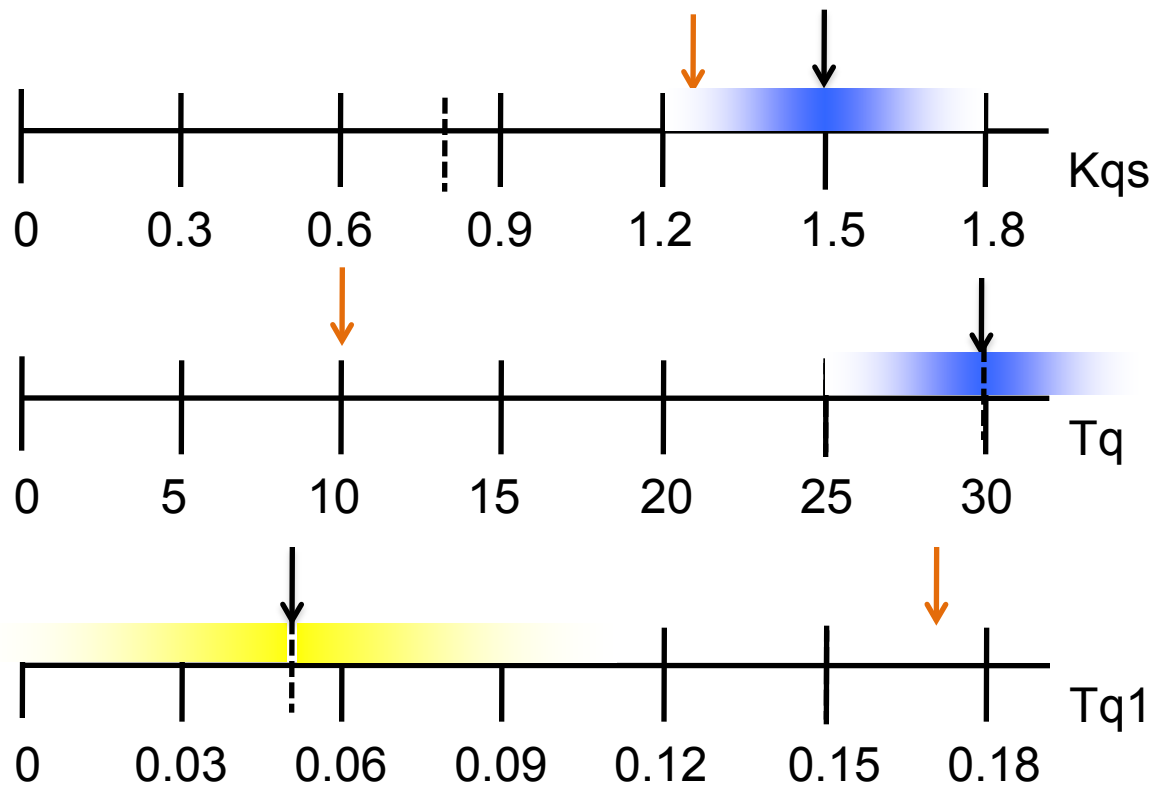



Three Test Cases

1. Recalibration: adjust parameter values
 - 4 study events, 2 verification events, + dozens of additional events studied by BPA.
2. Identify Structural Change: PSS Problem
 - Recalibrate parameters
 - Identify point at which PSS stops operating
3. Test Case – study process
 - Match disturbance data
 - Evaluate parameter values, and uncertainty.



Event Voltages

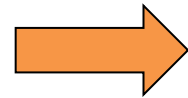
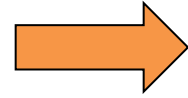
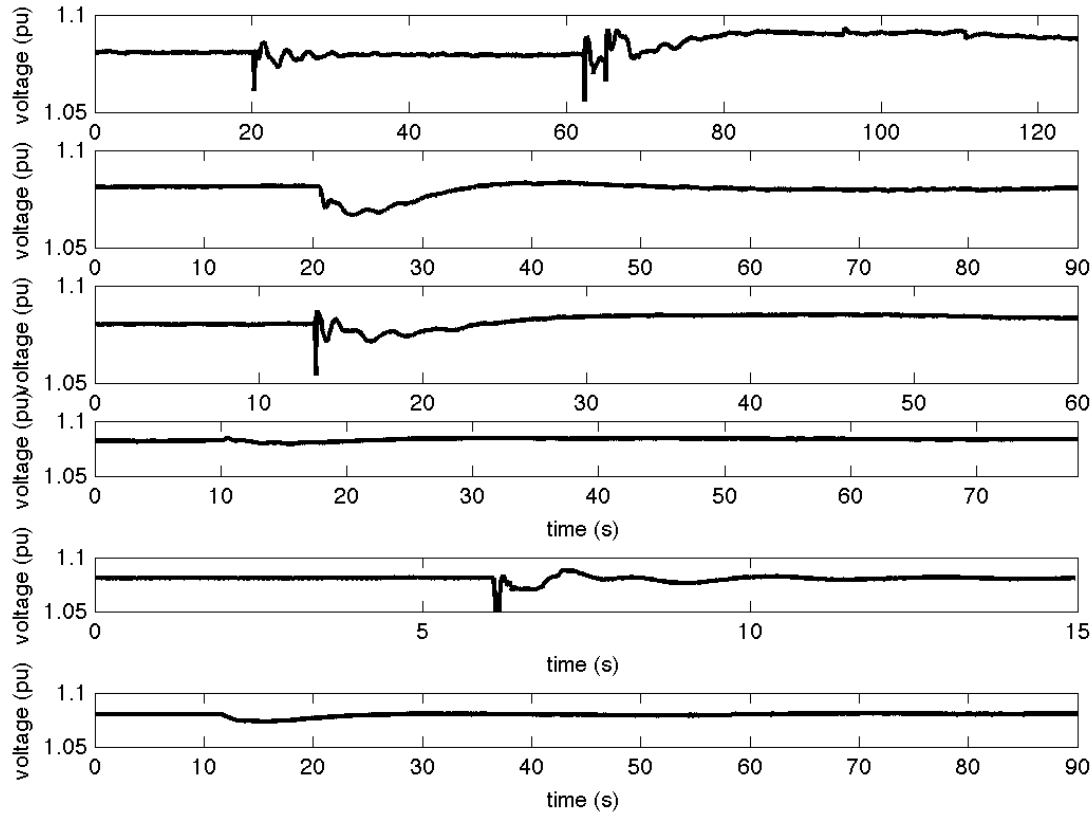
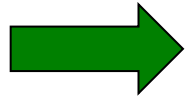
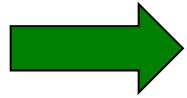
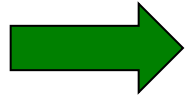
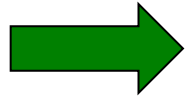



Event Frequencies

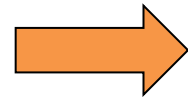
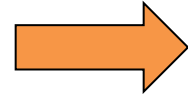
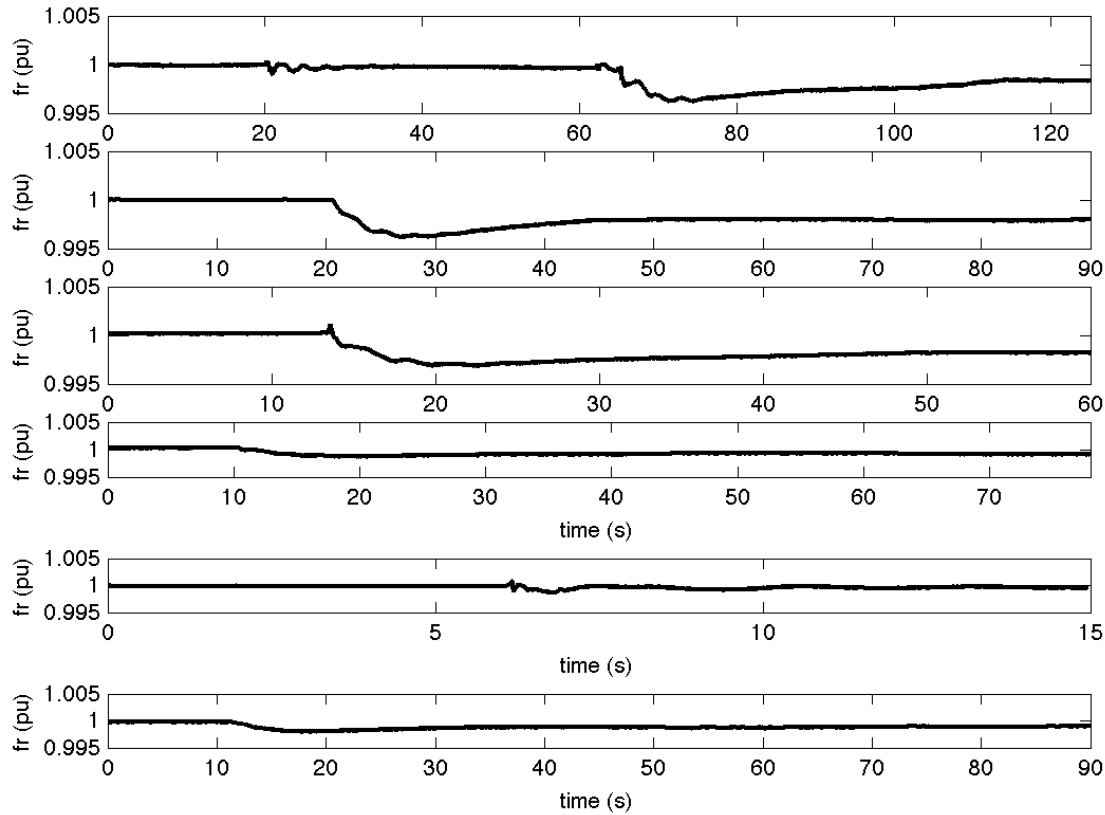
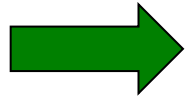
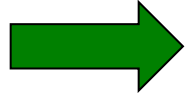
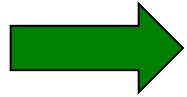
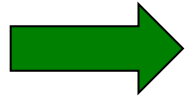



Event 1, part 1

Original Parameters

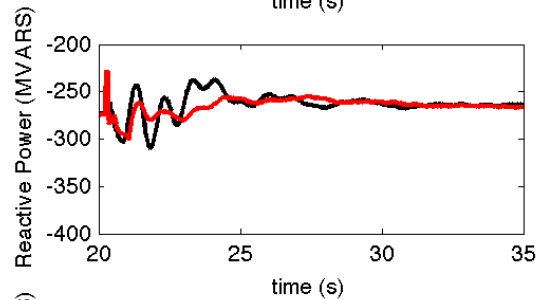
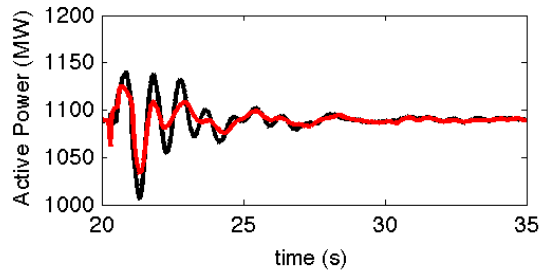
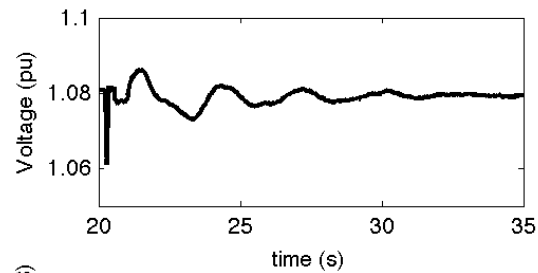
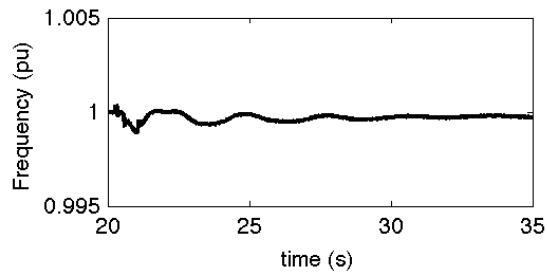

Modified Parameters

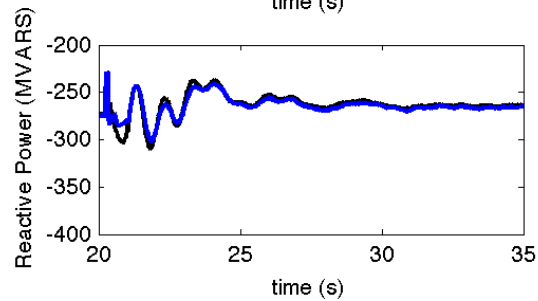
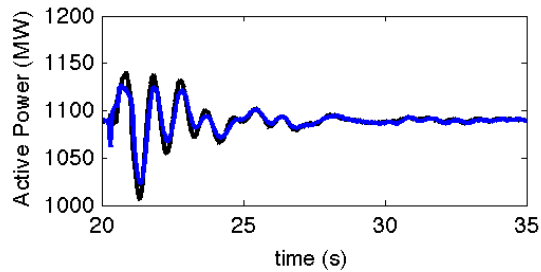



Event 1, part 2

Original
Parameters

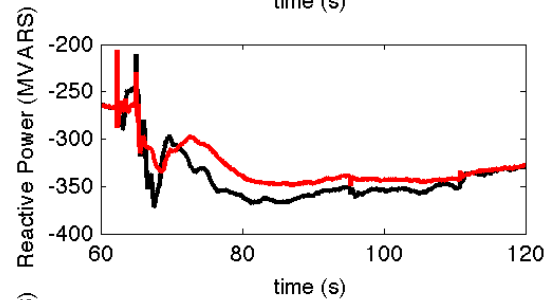
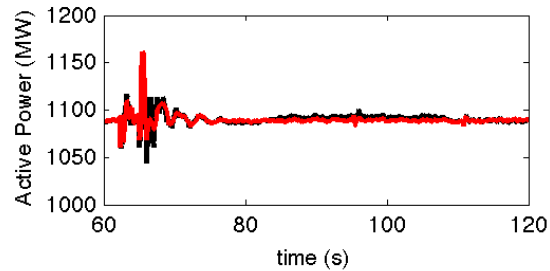
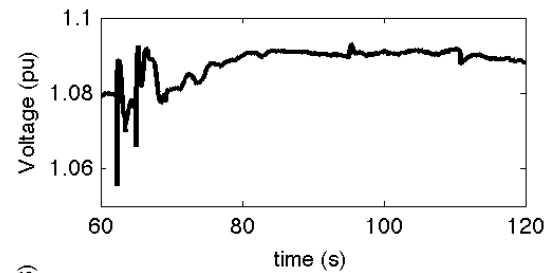
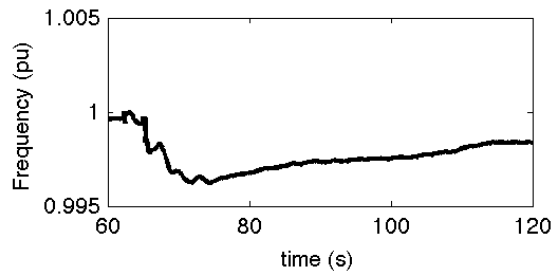

Modified
Parameters

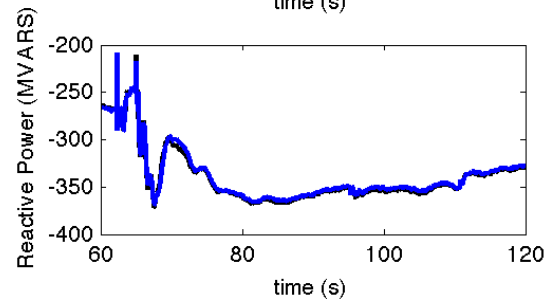
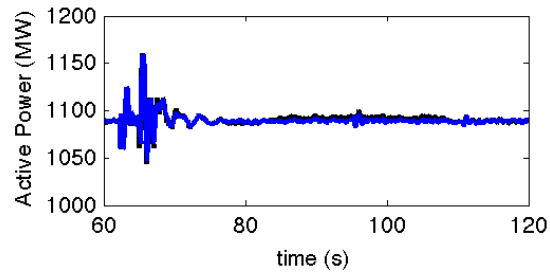



Event 1, part 2

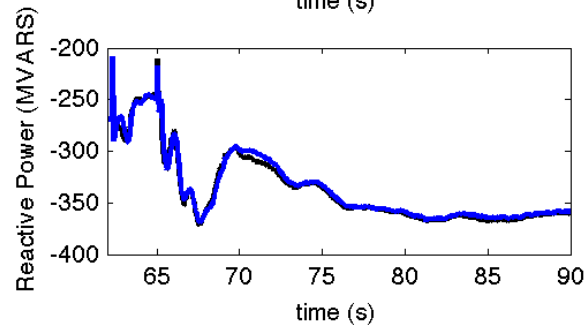
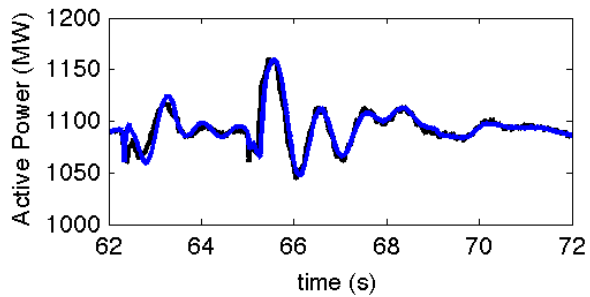
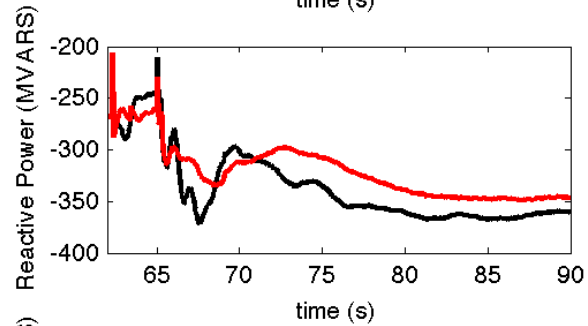
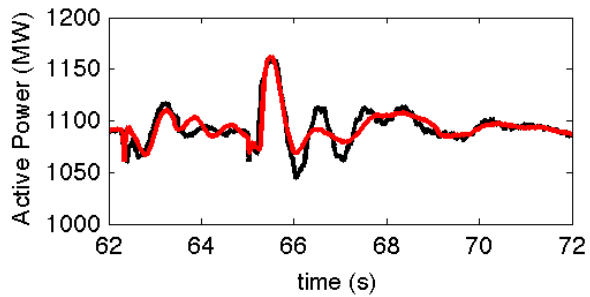
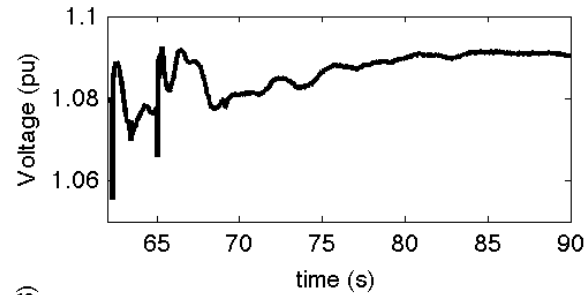
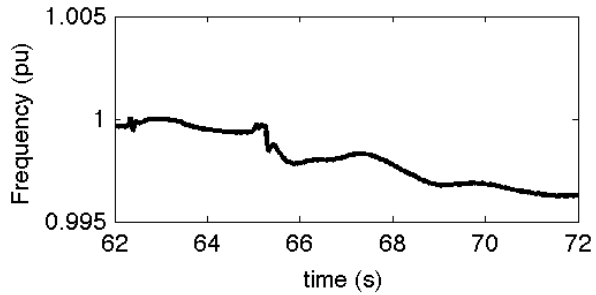



Event 3

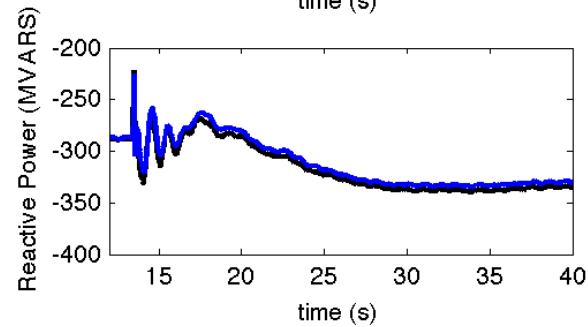
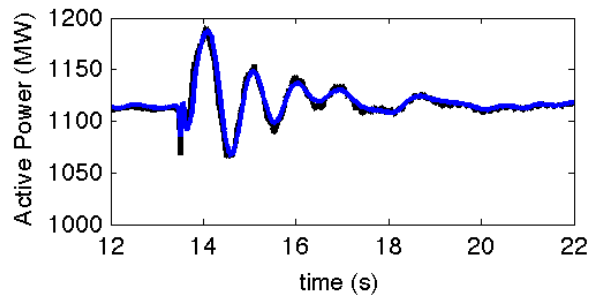
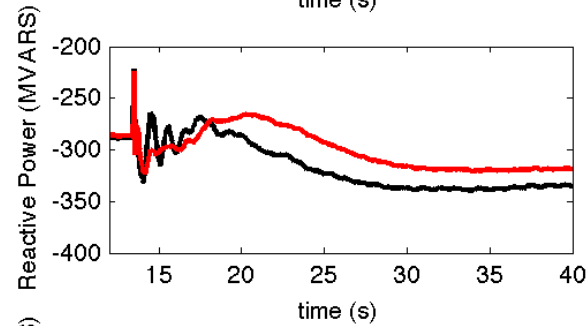
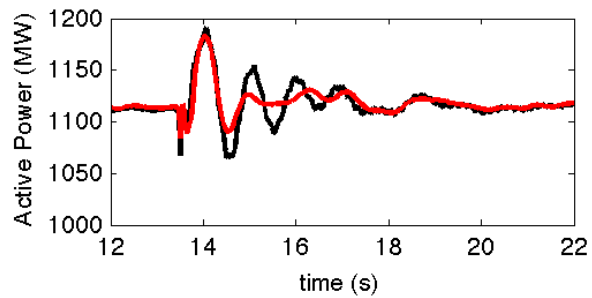
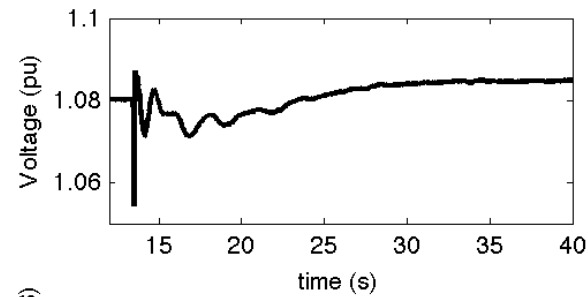
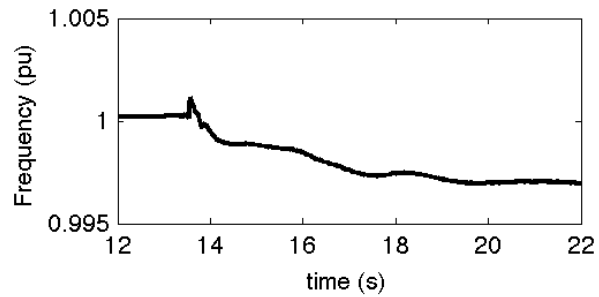



Event 4

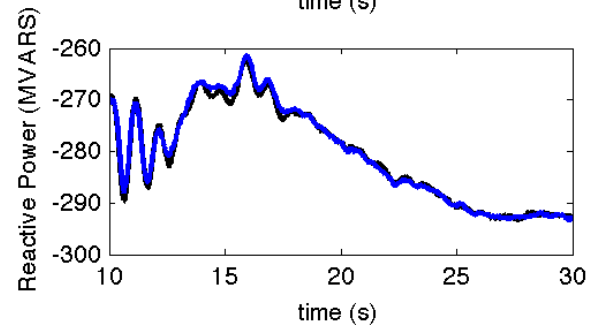
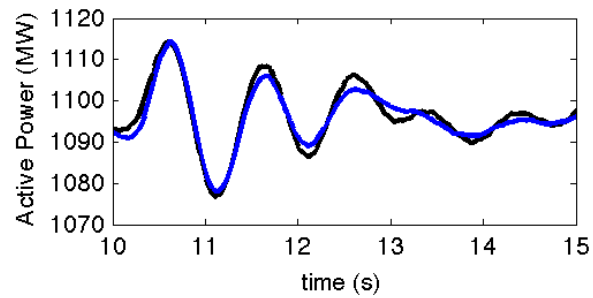
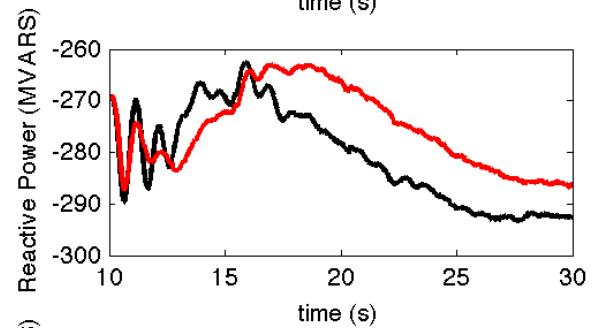
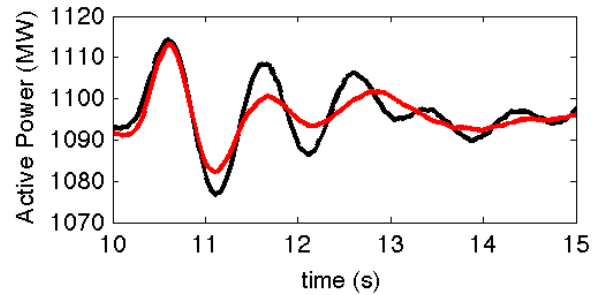
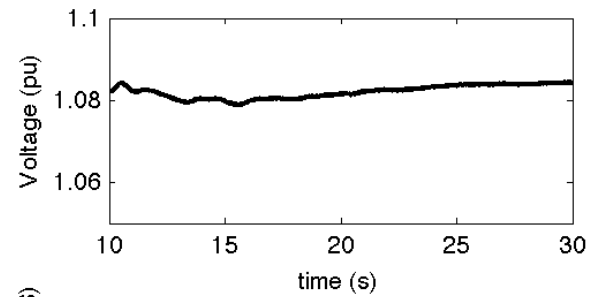
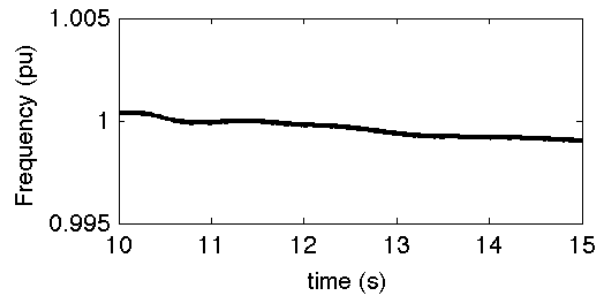



Event 5

Original Parameters

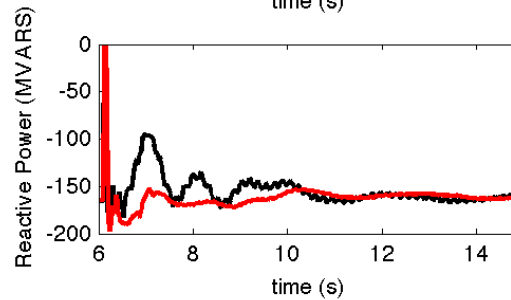
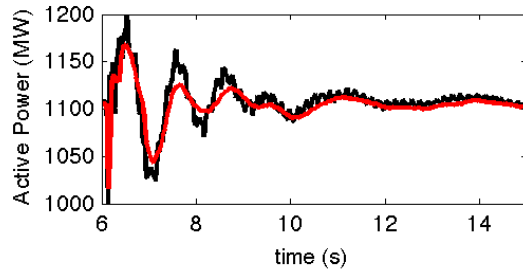
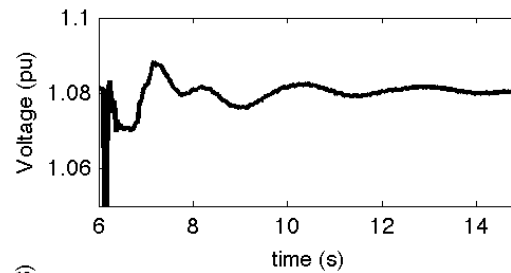
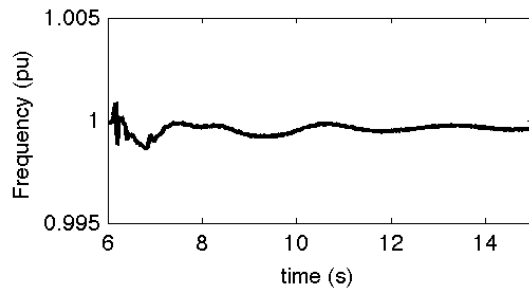

Modified Parameters

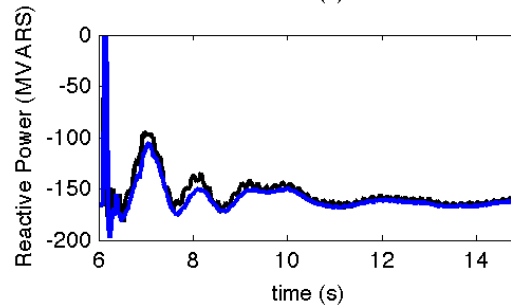
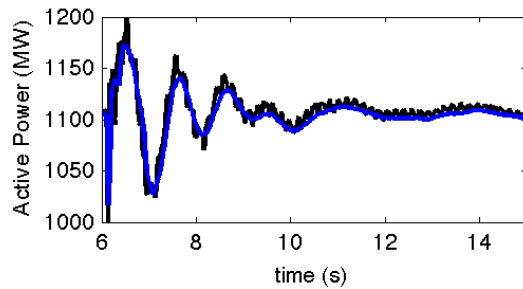



Validation: Event 2

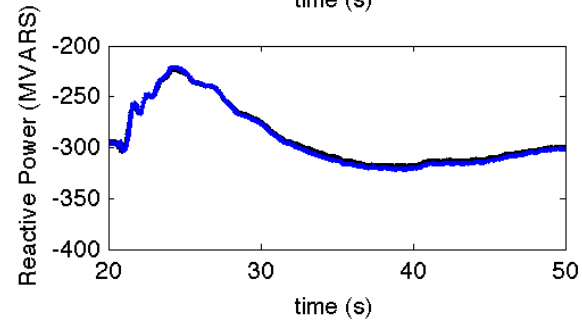
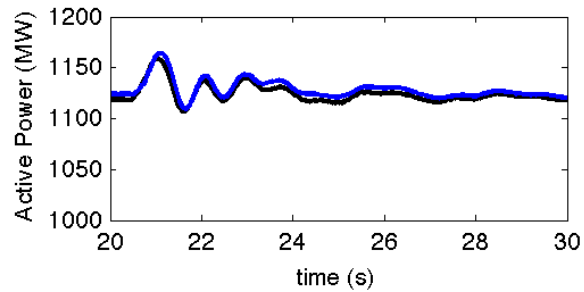
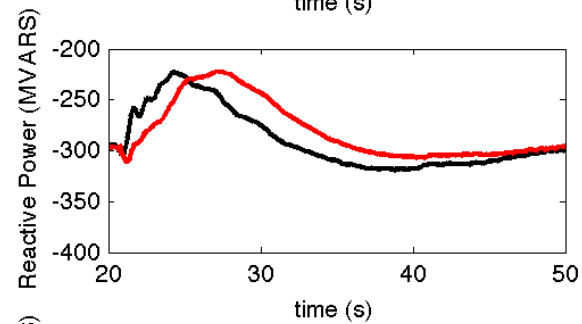
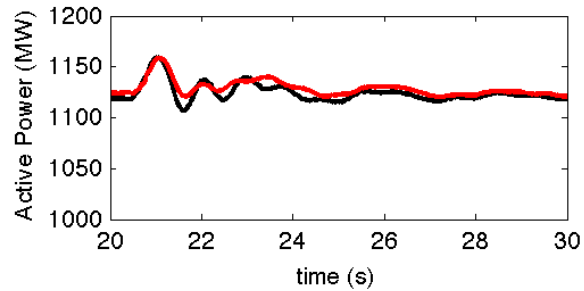
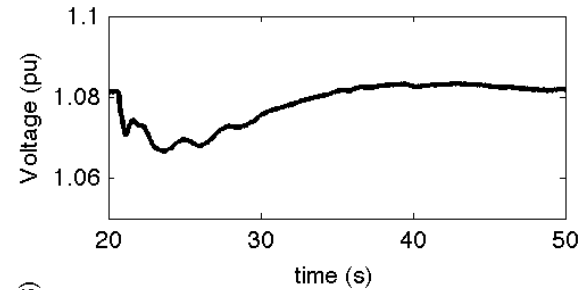
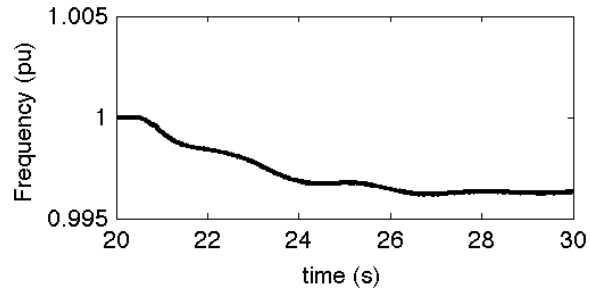



Validation: Event 6

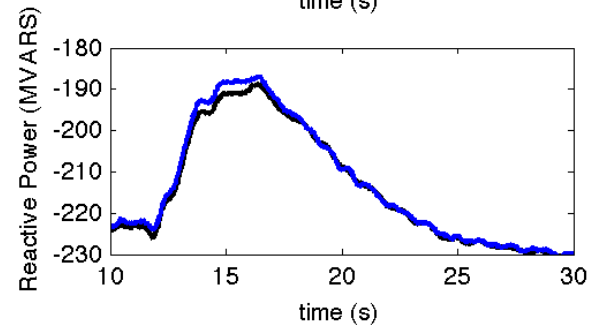
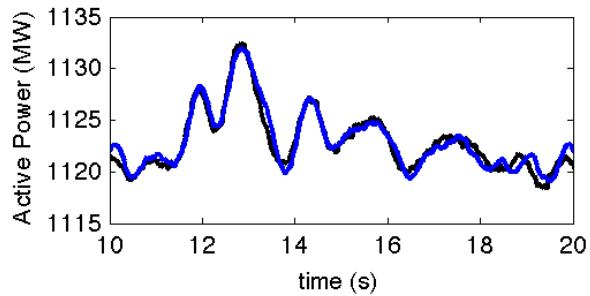
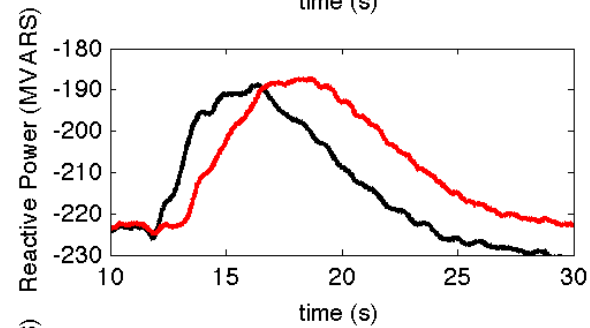
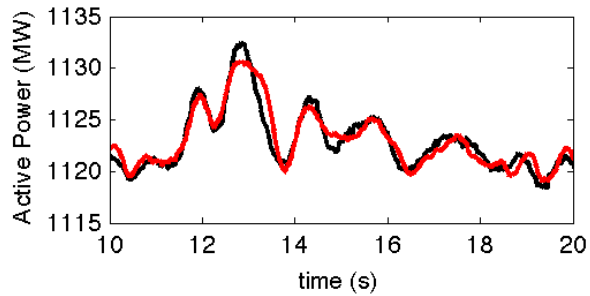
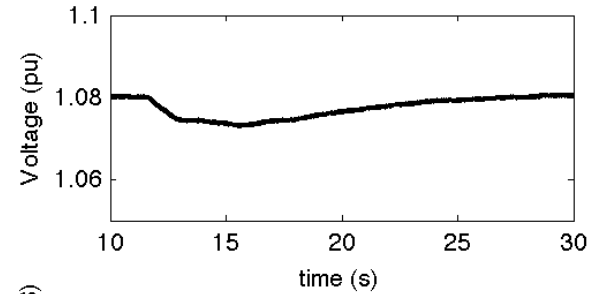
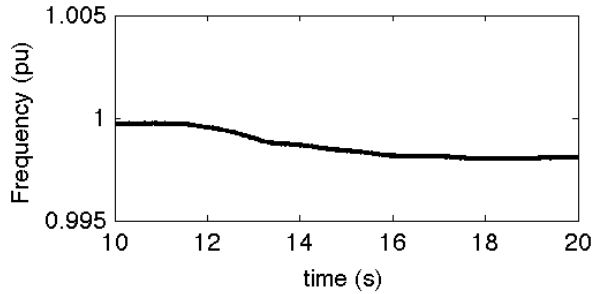



Second Plant

- Data from eight events over 14 months
- Parameters estimated using first two events
- Match is poor for events 4-8.
- Match is good when **PSS gain set to zero** for events 4-8.



Event 1

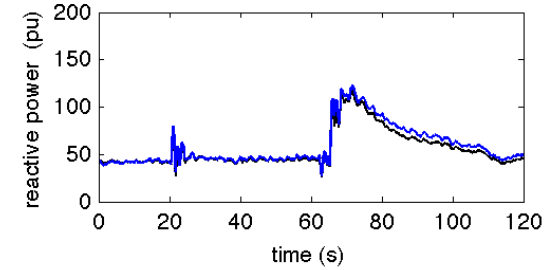
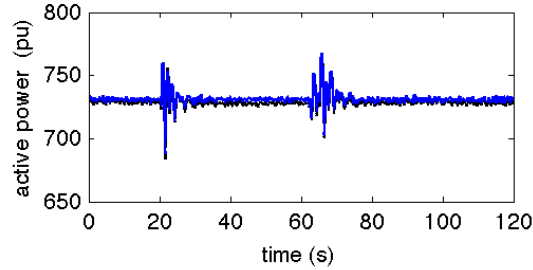
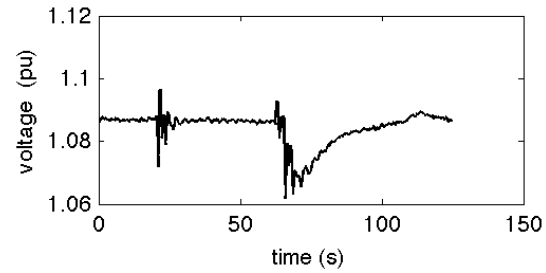
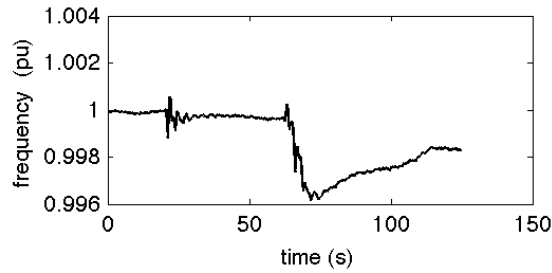

No PSS

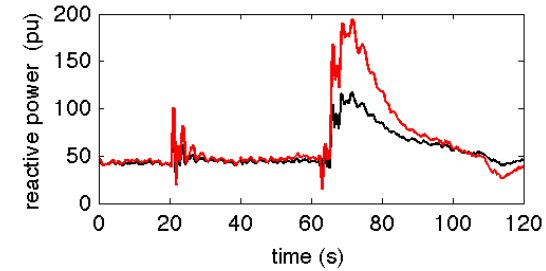
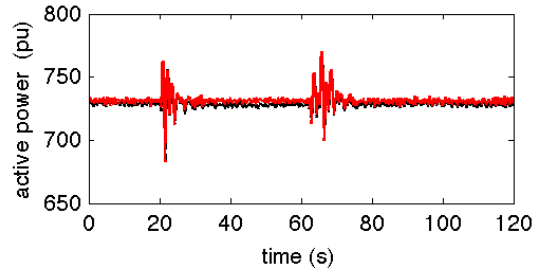



Event 2

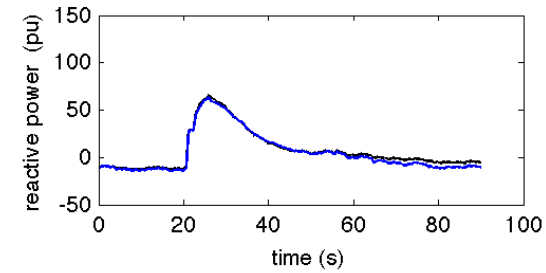
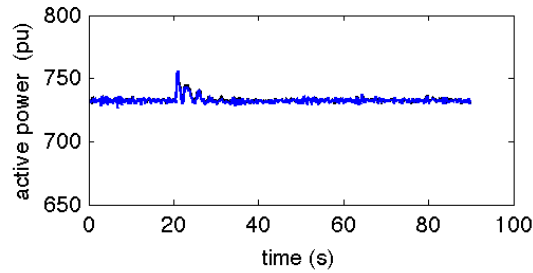
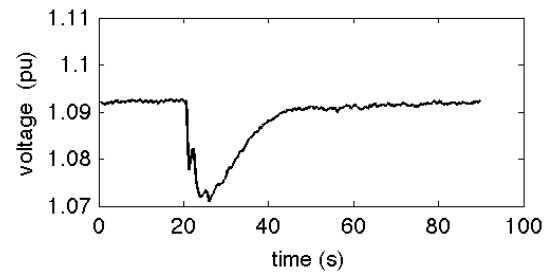
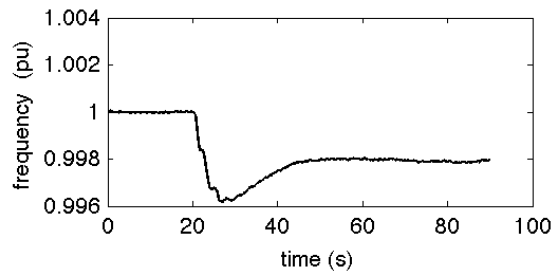

No PSS

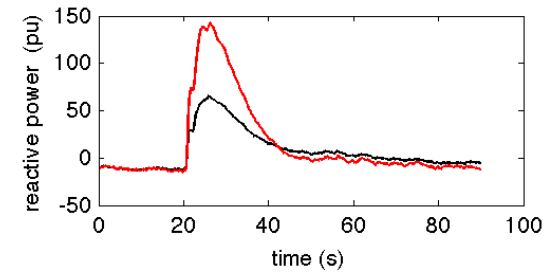
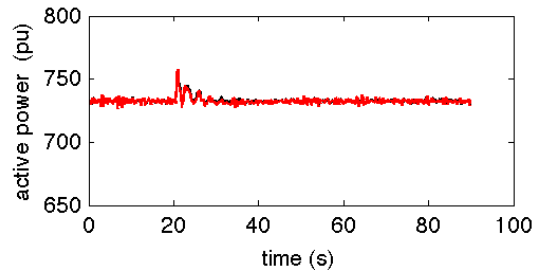



Event 3

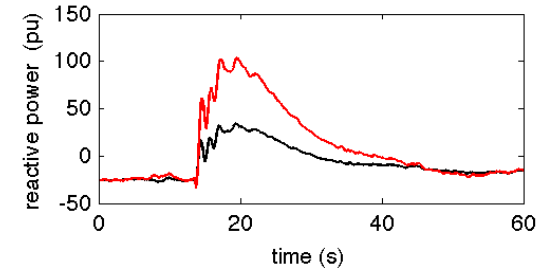
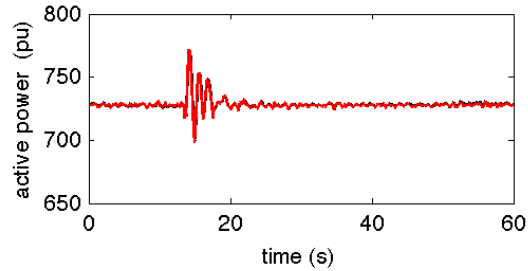
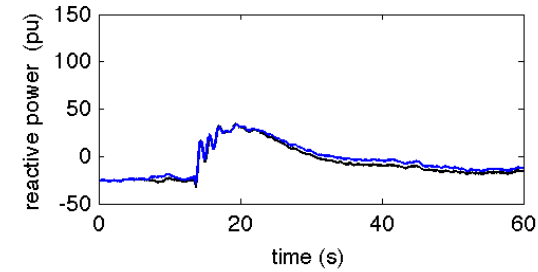
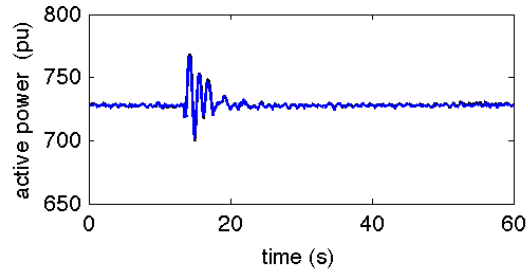
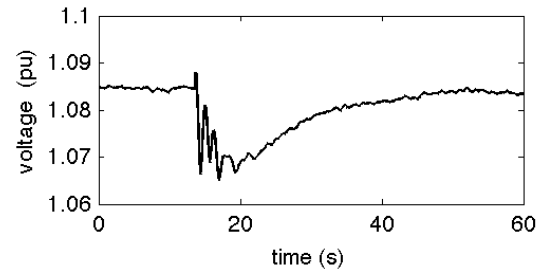
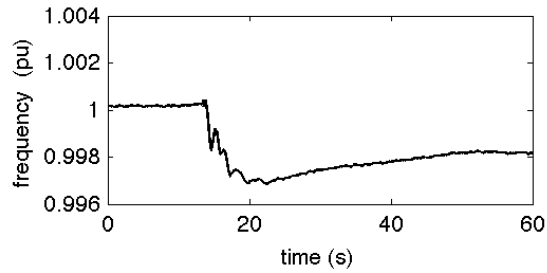

No PSS



Event 4

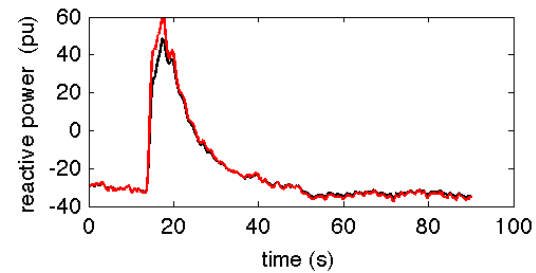
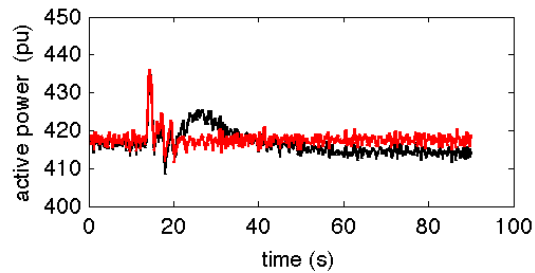
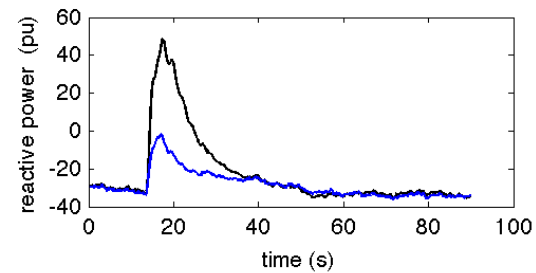
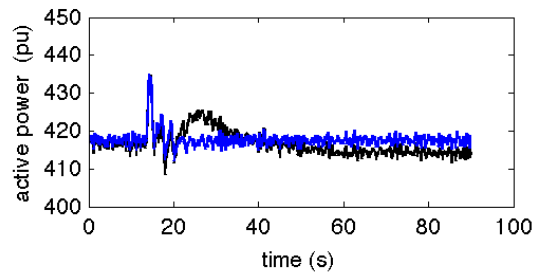
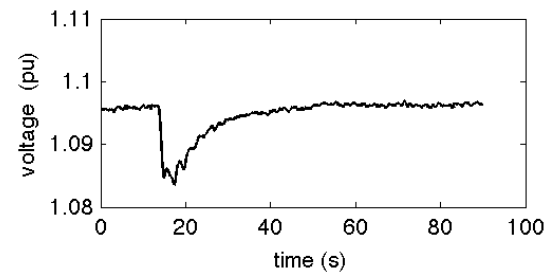
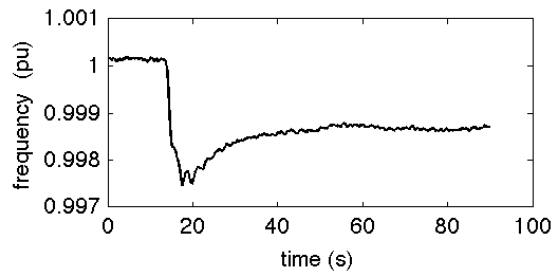

No PSS





Event 5

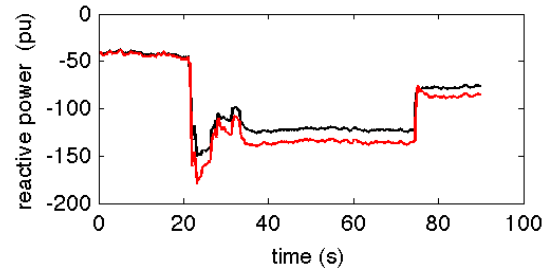
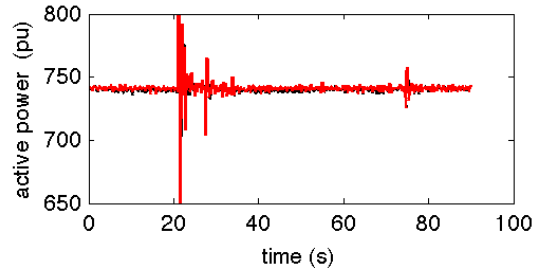
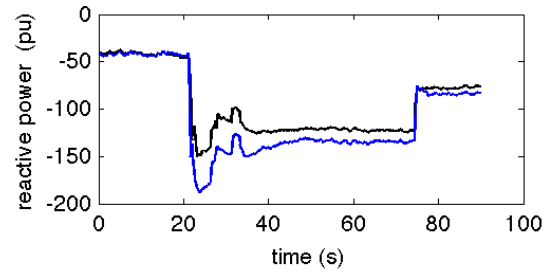
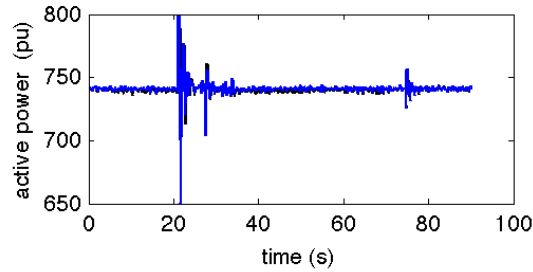
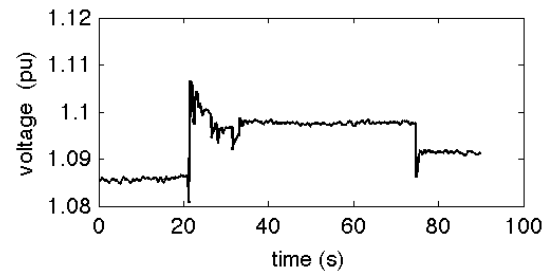
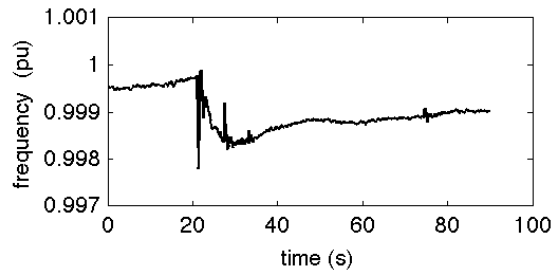

No PSS





Event 6

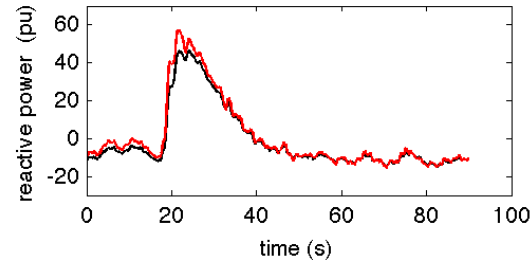
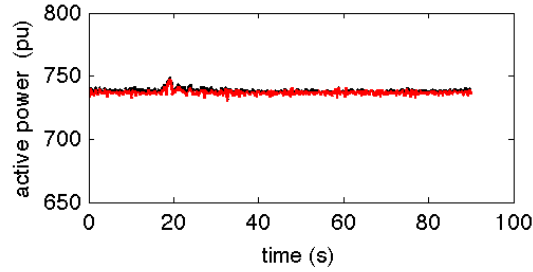
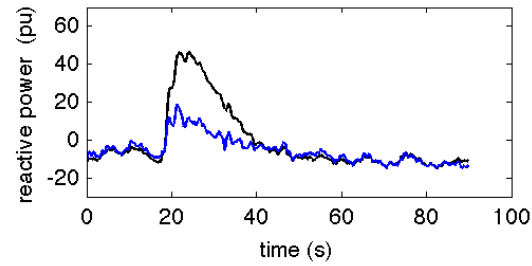
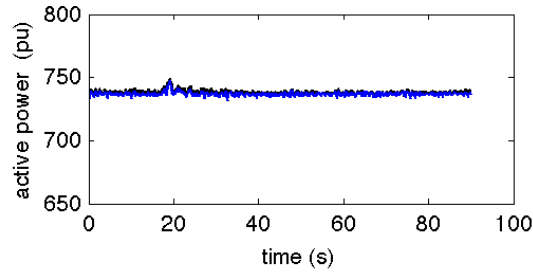
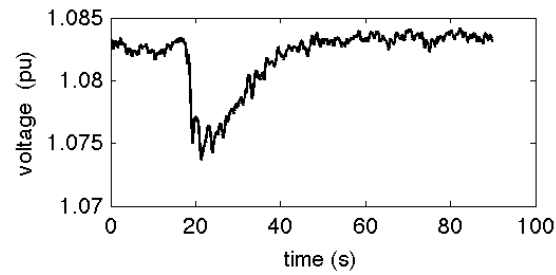
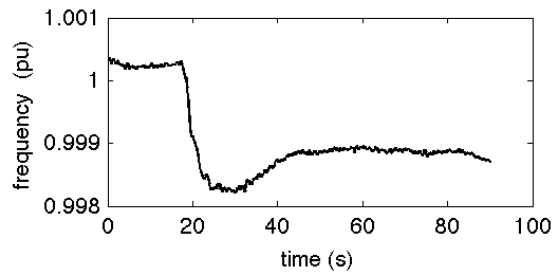

No PSS





Event 7

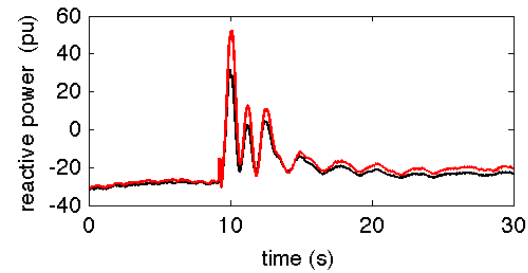
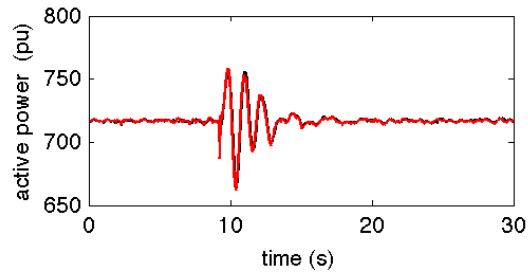
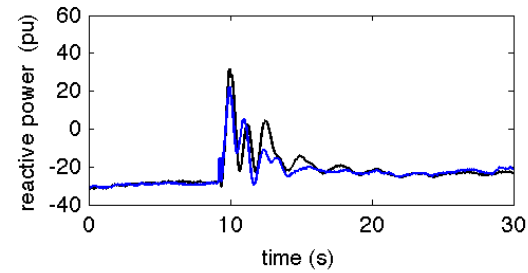
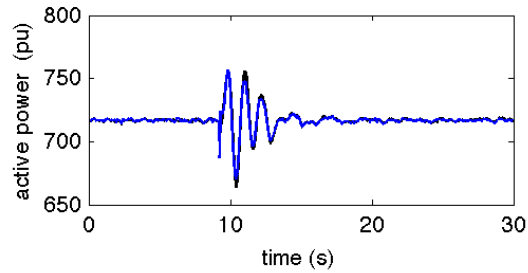
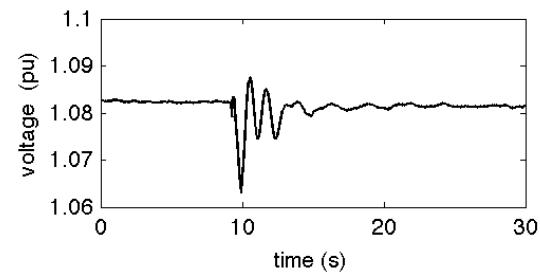
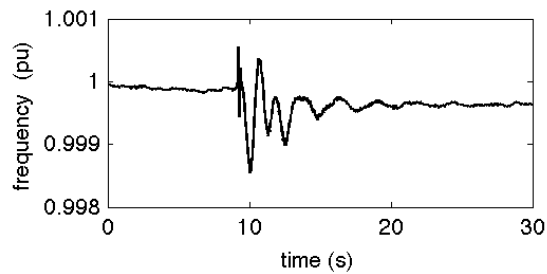

No PSS





Event 8

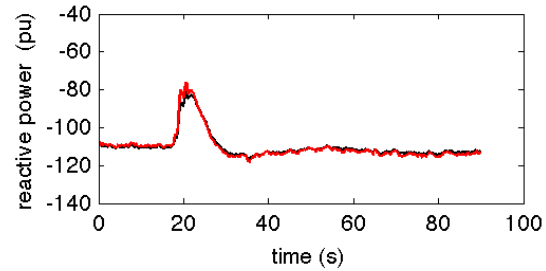
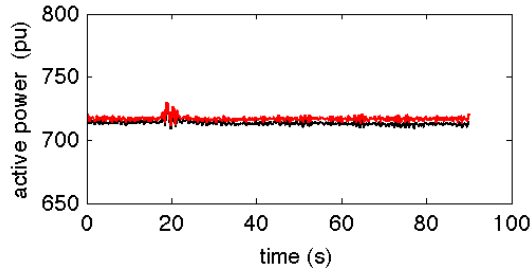
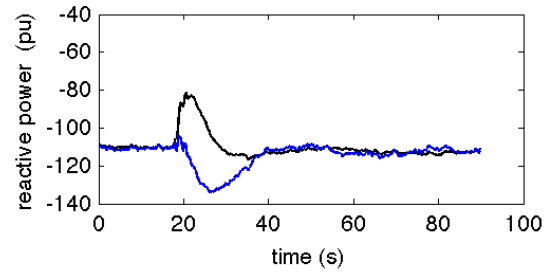
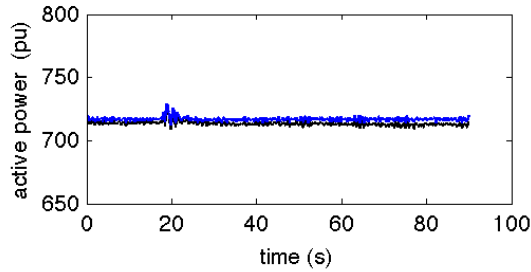
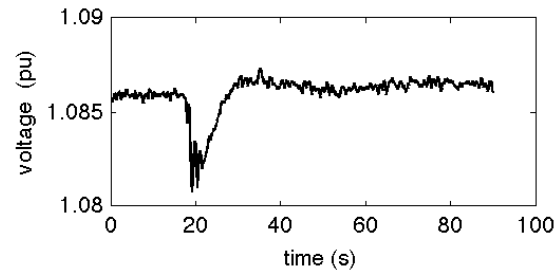
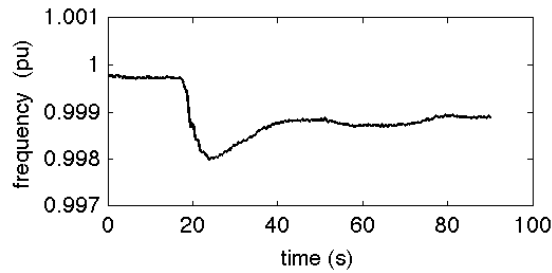

No PSS





Example 2 Conclusion

For this plant, the simulations are consistent with the hypothesis that the PSS is operating differently for the latter events than for the earlier events.

The process also involved recalibration of parameter values.



Example 3: Model Calibration Test

- Data from 7 simulated events
 - 3 sets used for model calibration
 - 4 sets used for model consistency check
 - + model independently checked by others using data from other events

Discuss need for engineers - best parameter sets



Test Case Voltages

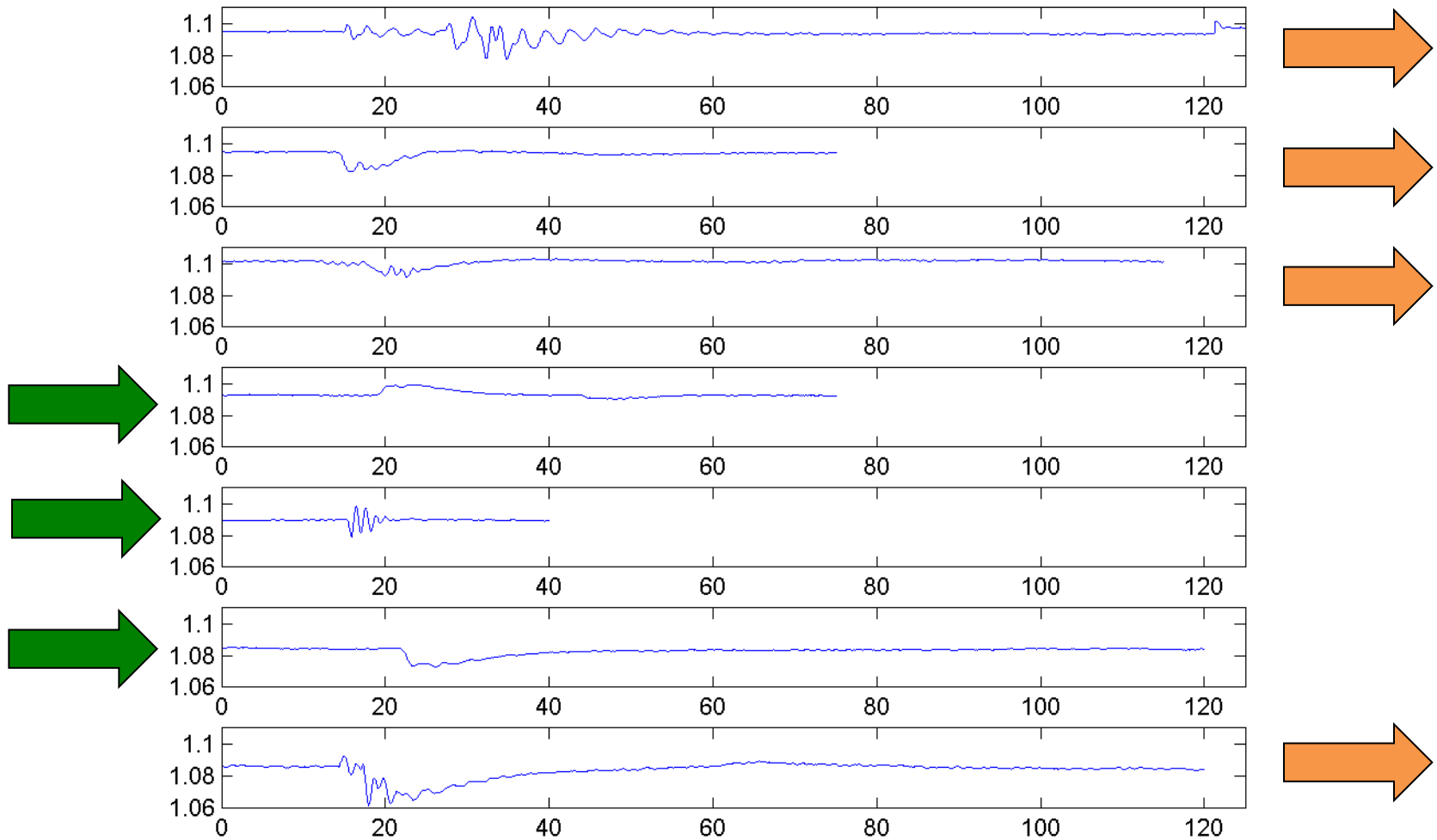



Test Case Frequencies

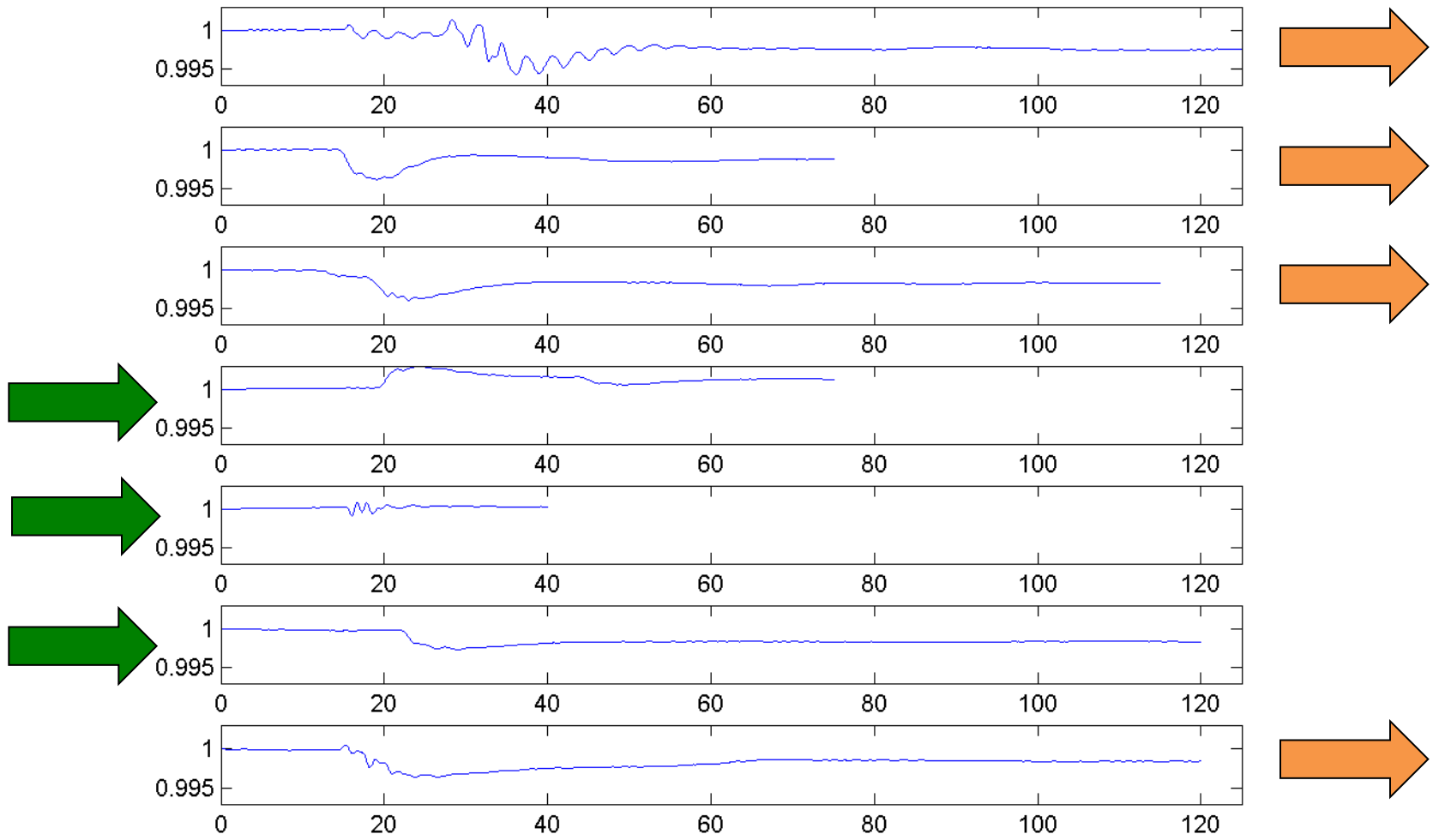



Event 1

Original Parameters

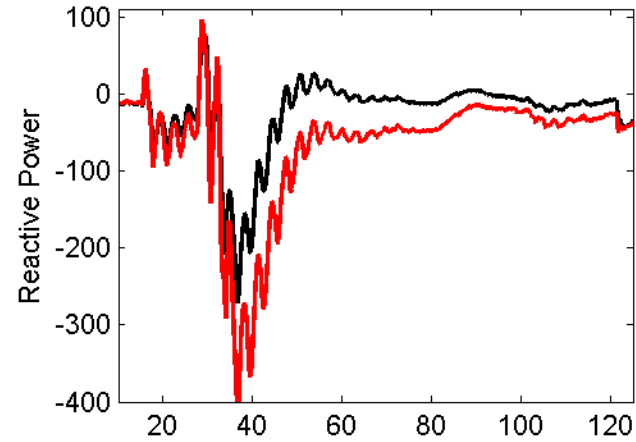
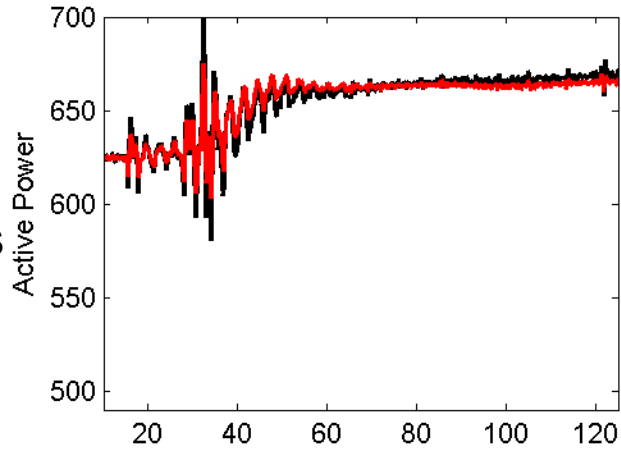

Modified Parameters

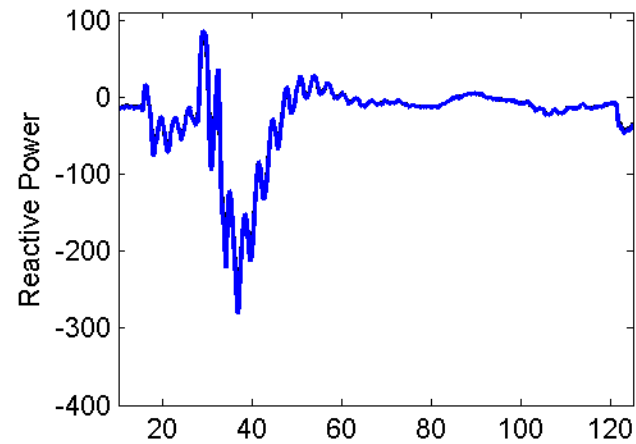
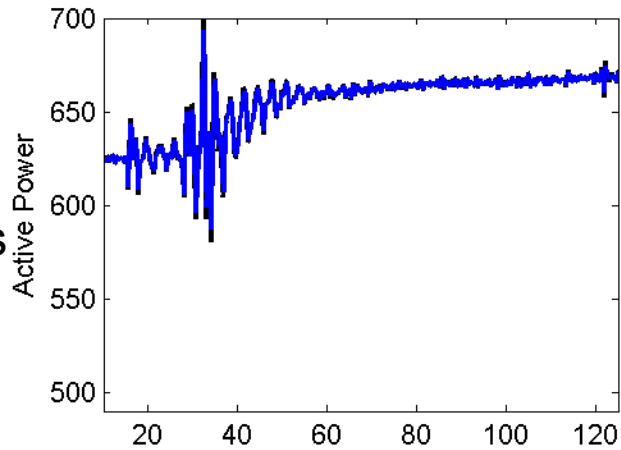



Event 2

Original
Parameters

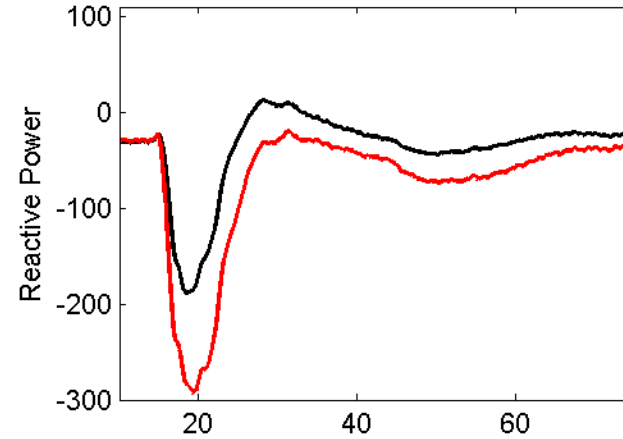
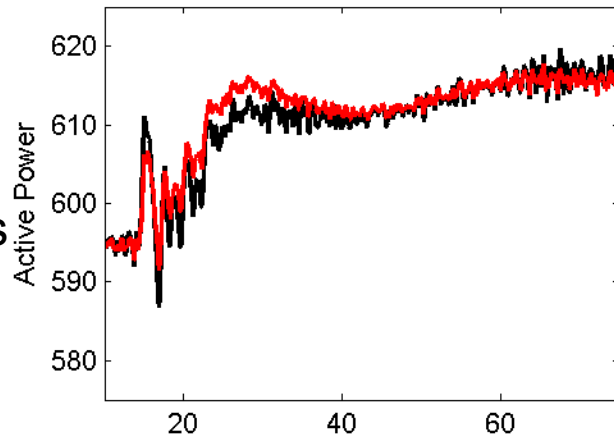

Modified
Parameters

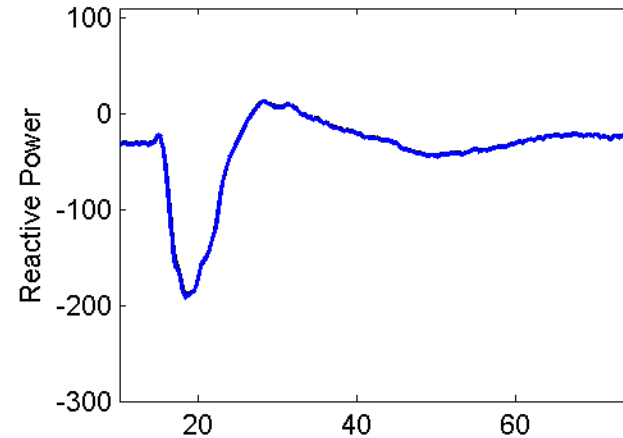
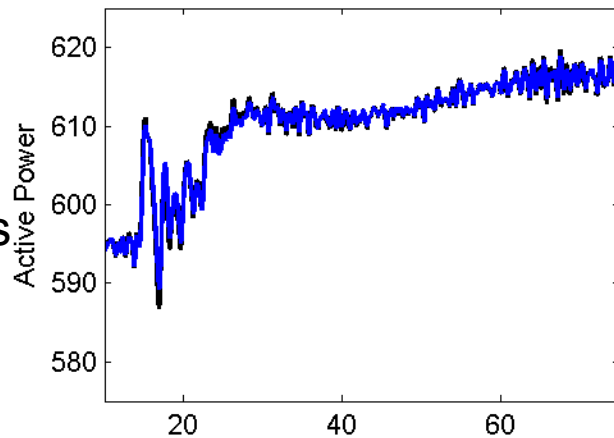



Event 3

Original
Parameters

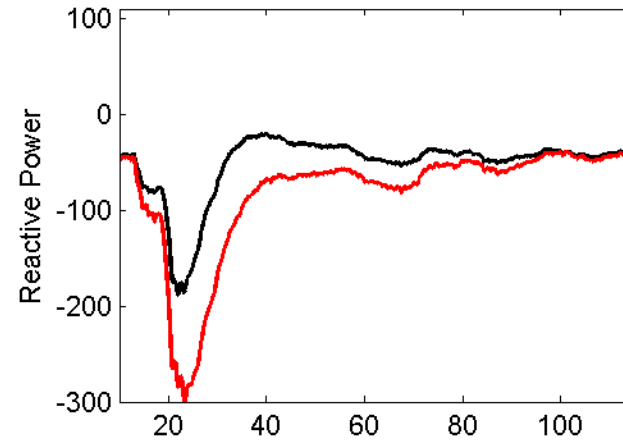
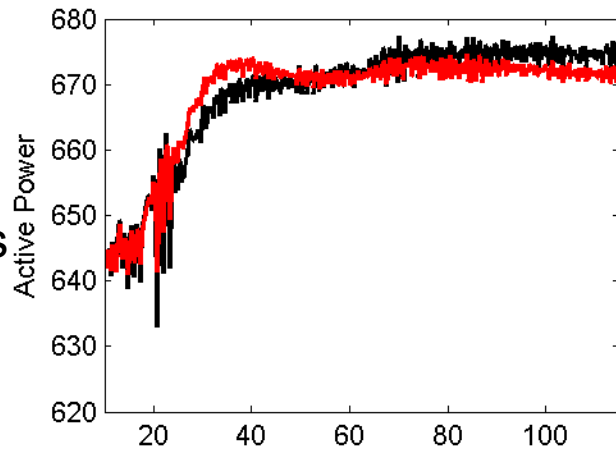

Modified
Parameters

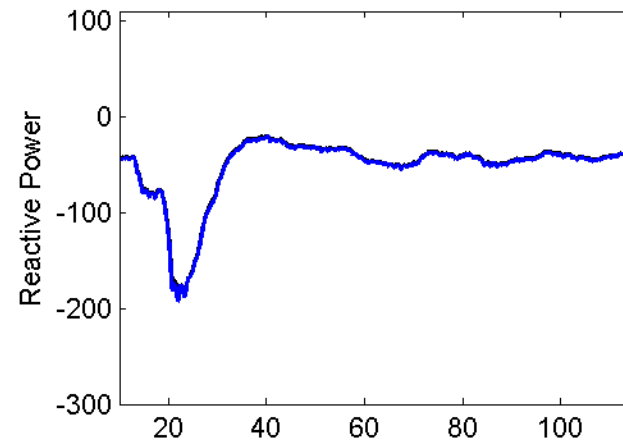
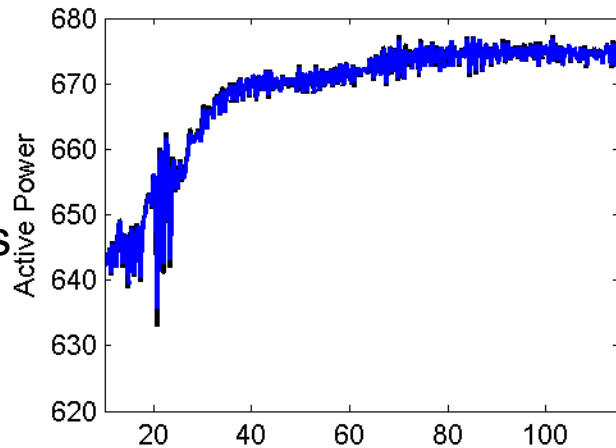



Event 4

Original
Parameters

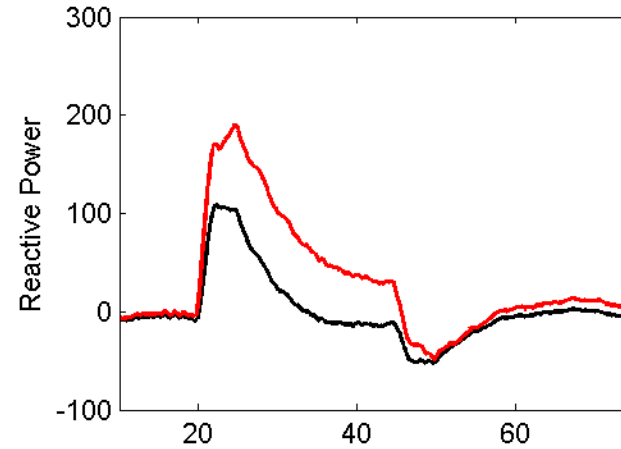
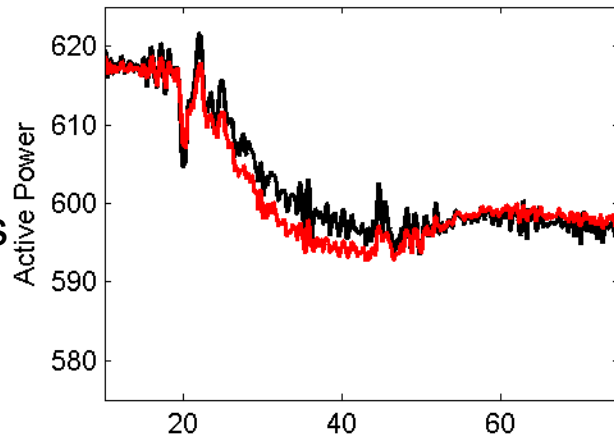

Modified
Parameters

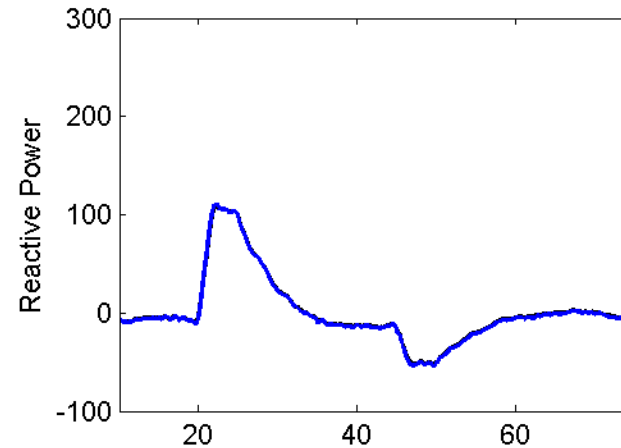
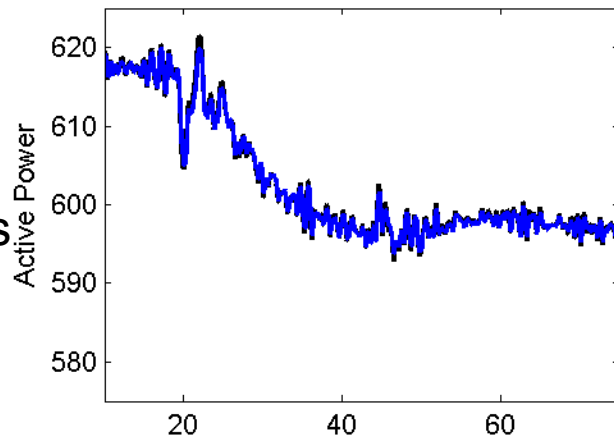



Event 5

Original
Parameters

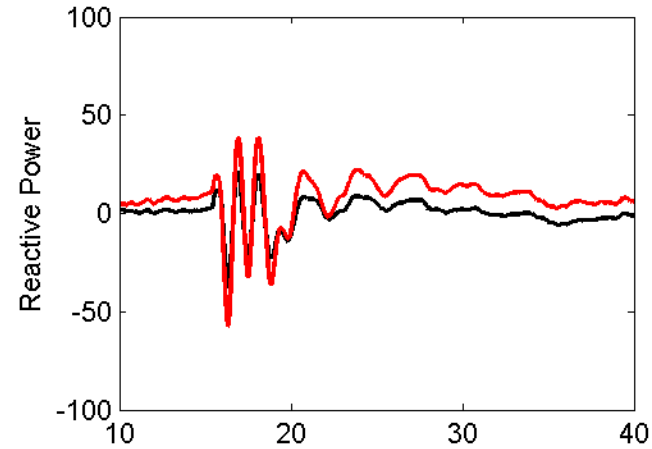
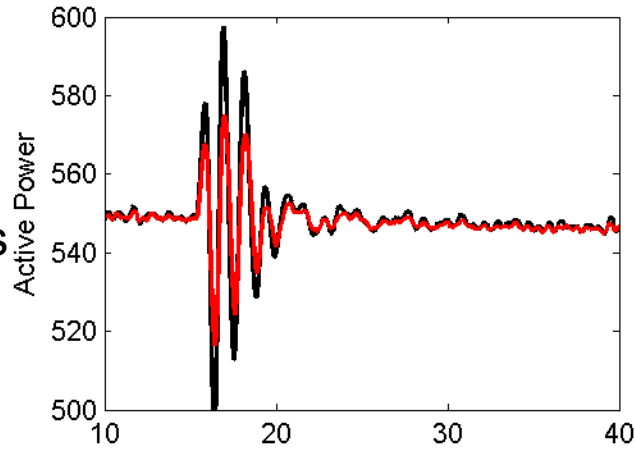

Modified
Parameters

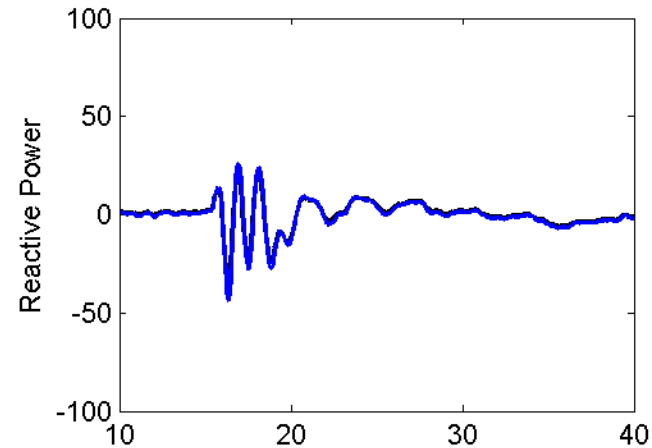
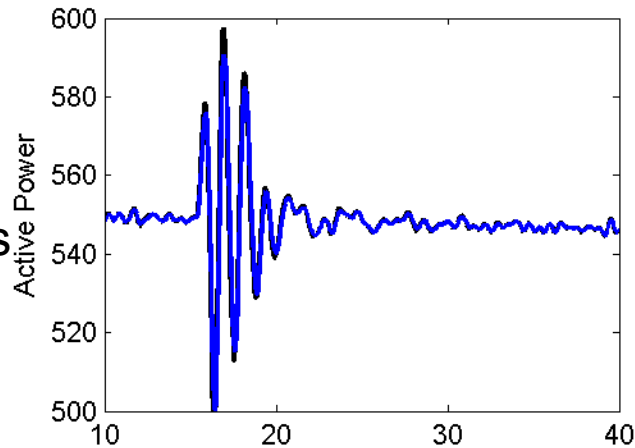



Event 6

Original Parameters

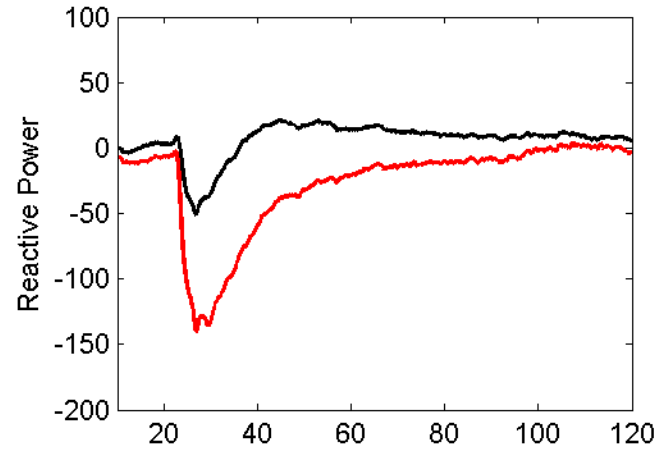
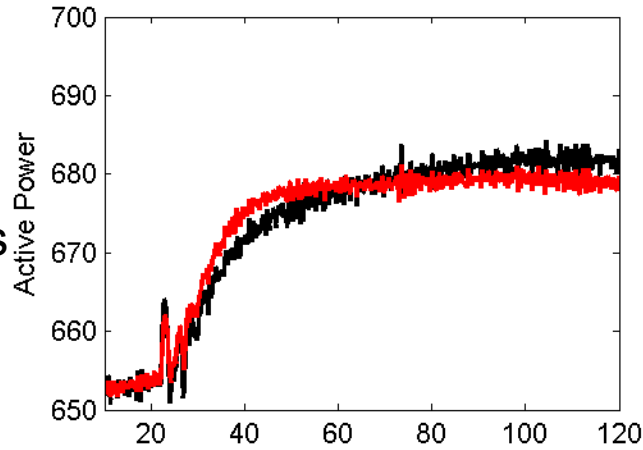

Modified Parameters

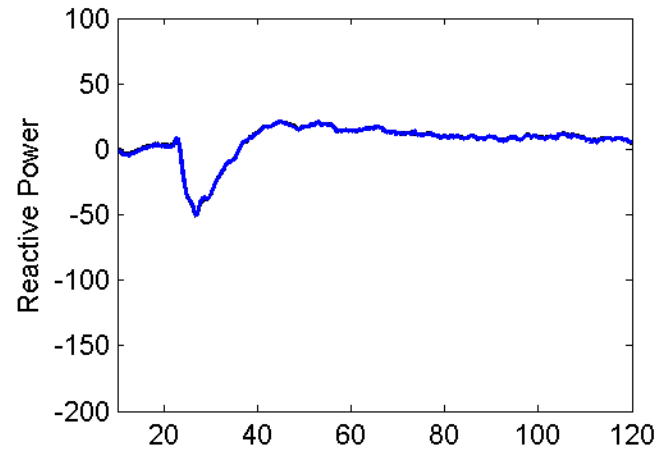
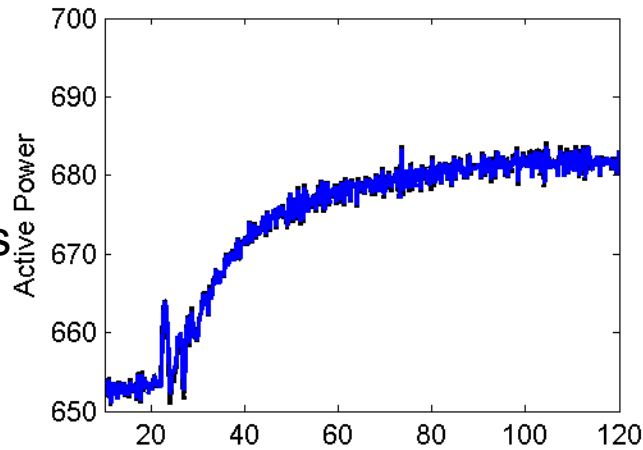



Event 7

Original Parameters

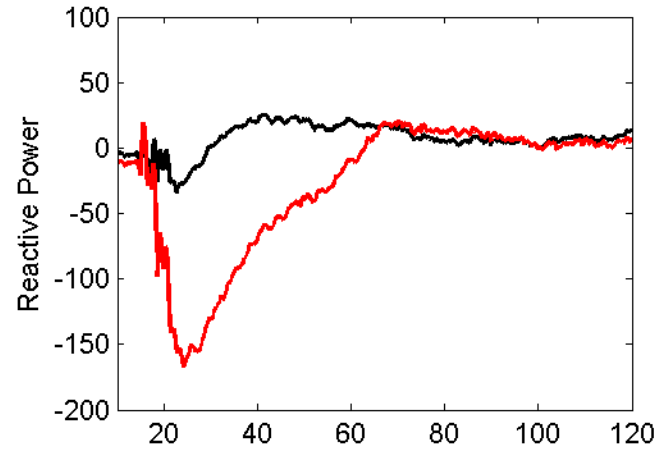
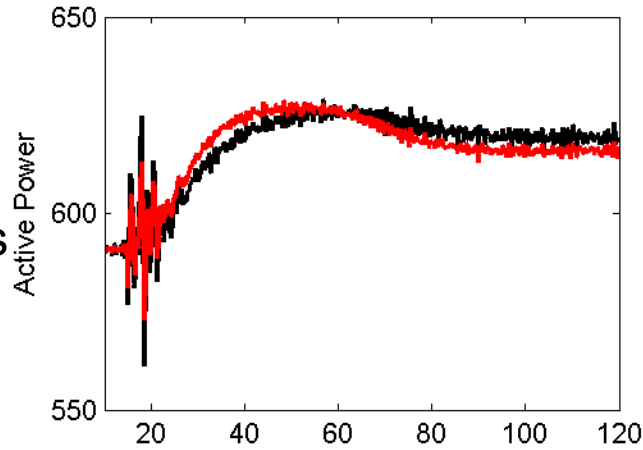

Modified Parameters

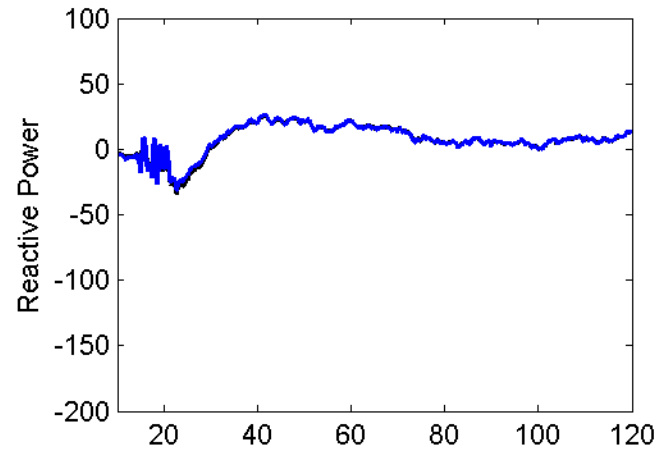
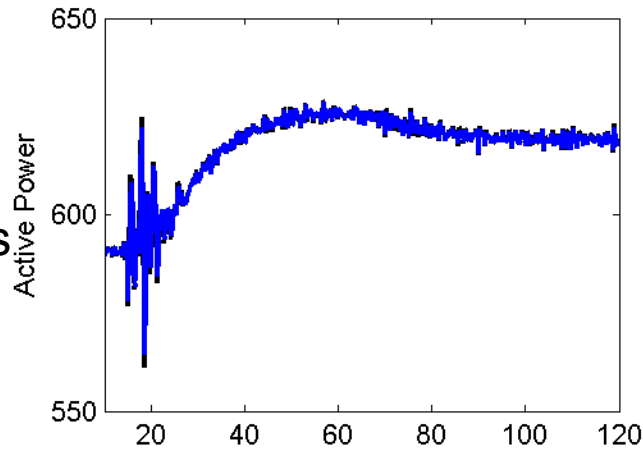



Too Many Knobs to Turn

Analyses of the sensitivity model and of the parameter covariance matrix suggests that certain parameter adjustments will have negligible affect on the simulations.



Fit for values of $Ka=443$, 400, and 250.

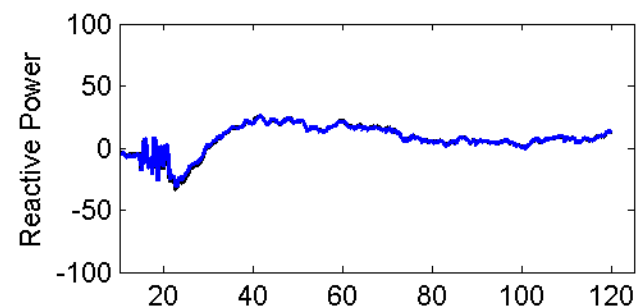
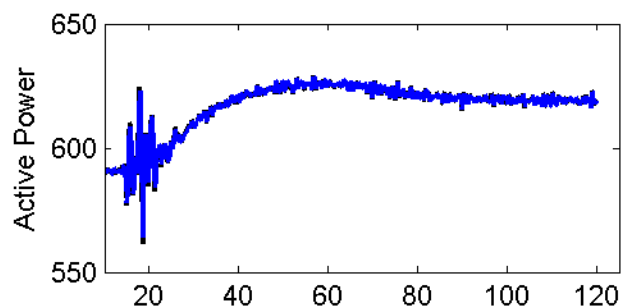
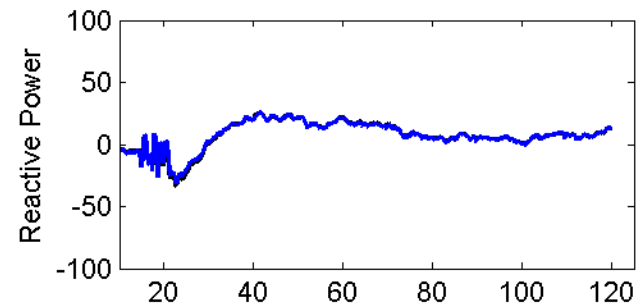
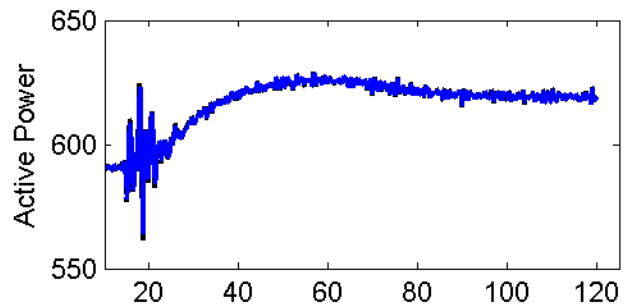
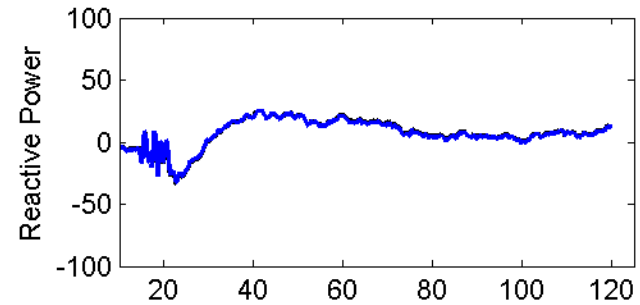
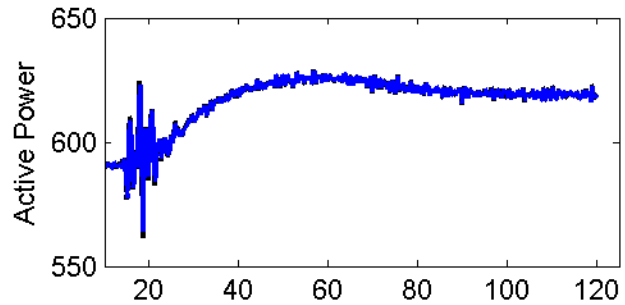

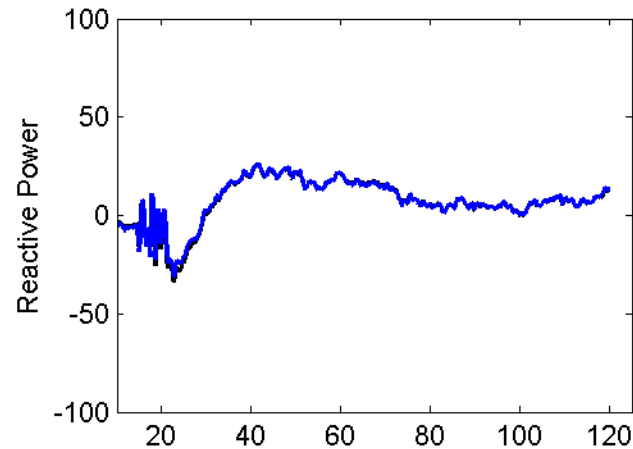
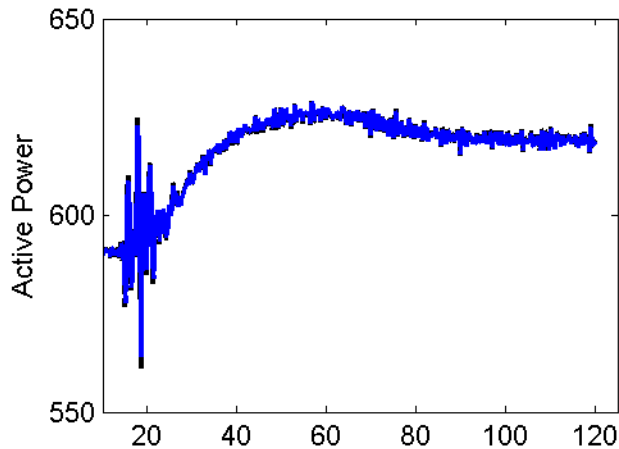
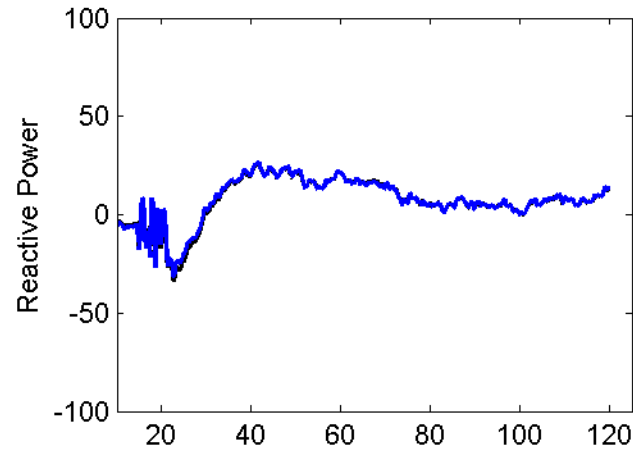
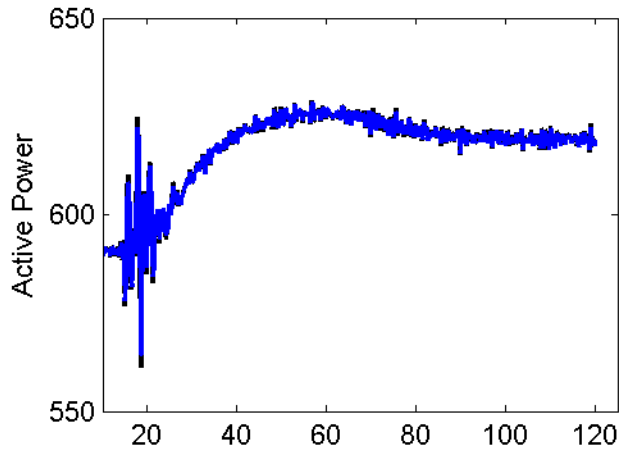

H	4.42	4.42
Xc	0.052	0.052
Ka	443	400
Kf	0.021	0.021
Tf	0.79	0.78
T5	12.6	12.6
Ks	8.23	8.23
Rp	0.045	0.045
Rt	0.46	0.50
Tr	1.82	1.65
Tw	1.76	1.76

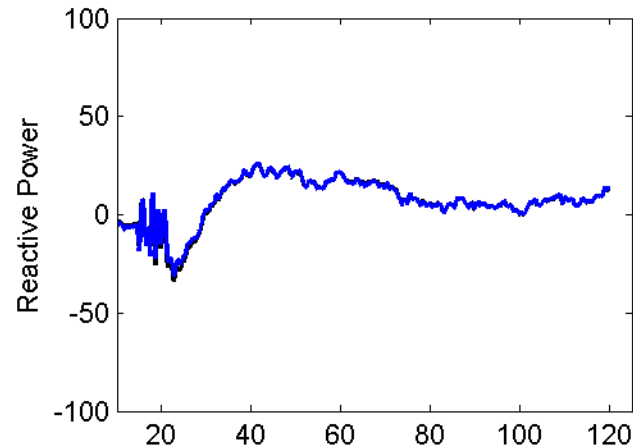
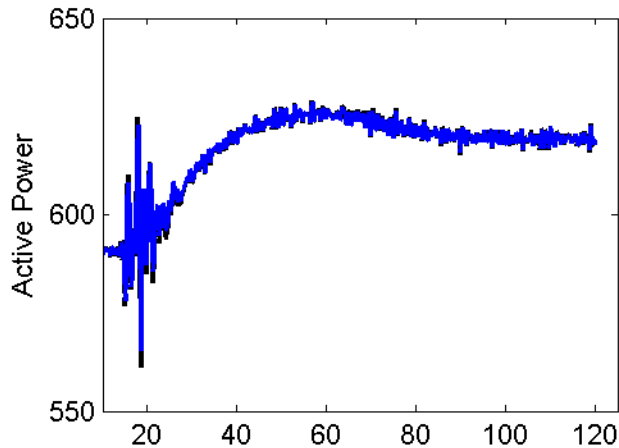
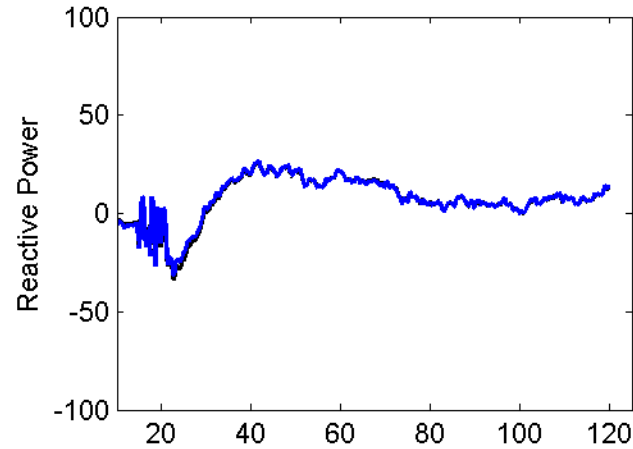
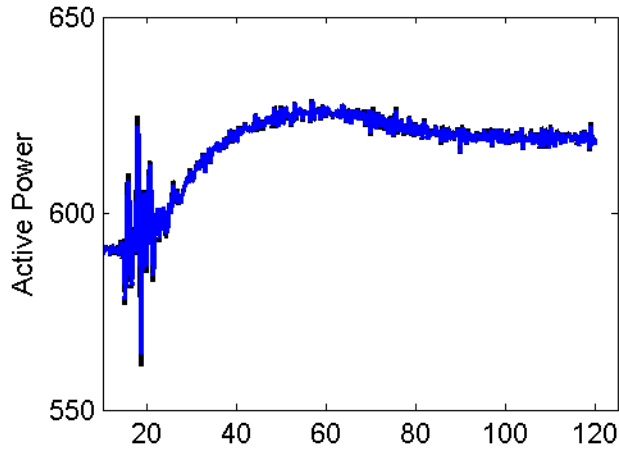

H	4.42	4.38
Xc	0.052	0.052
Ka	443	400
Kf	0.021	0.021
Tf	0.79	0.77
T5	12.6	12.6
Ks	8.23	8.25
Rp	0.045	0.045
Rt	0.46	0.52
Tr	1.82	1.67
Tw	1.76	1.27

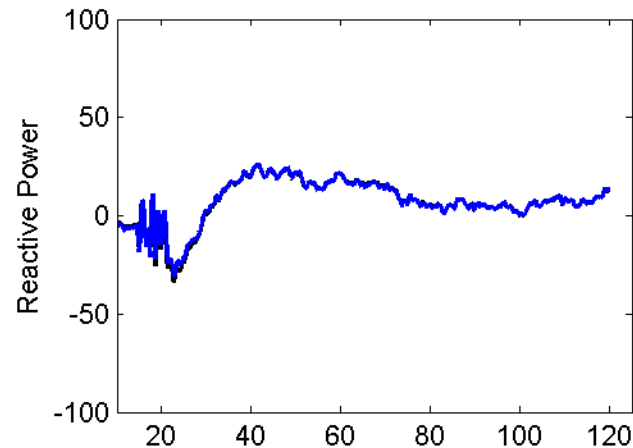
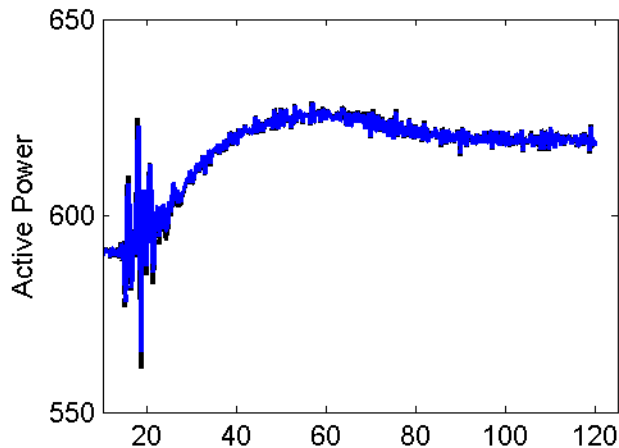
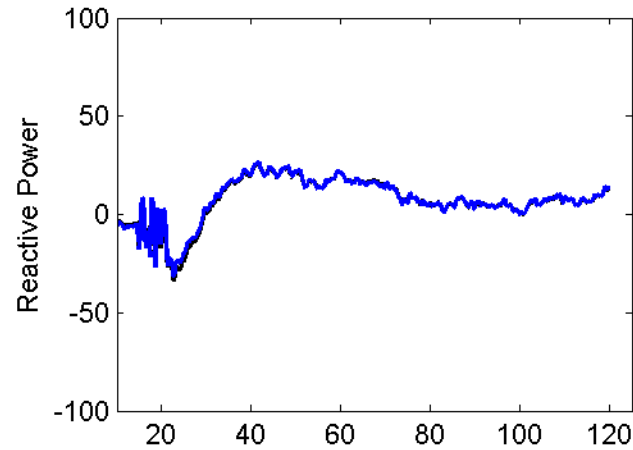
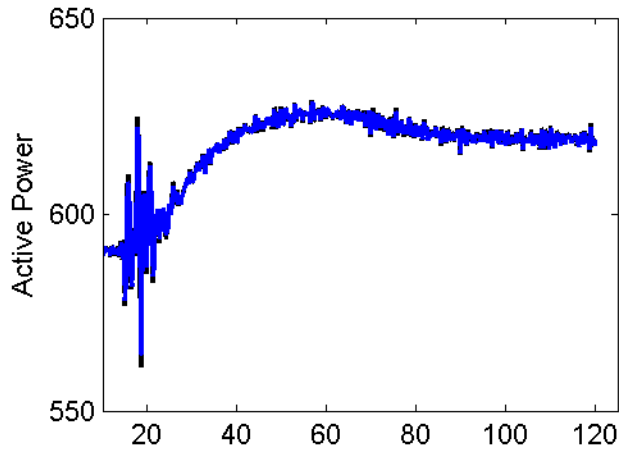

H	4.42	3.62
Xc	0.052	0.052
Ka	443	400
Kf	0.021	0.020
Tf	0.79	0.71
T5	12.6	12.6
Ks	8.23	8.27
Rp	0.045	0.045
Rt	0.46	0.50
Tr	1.82	1.74
Tw	1.76	1.27

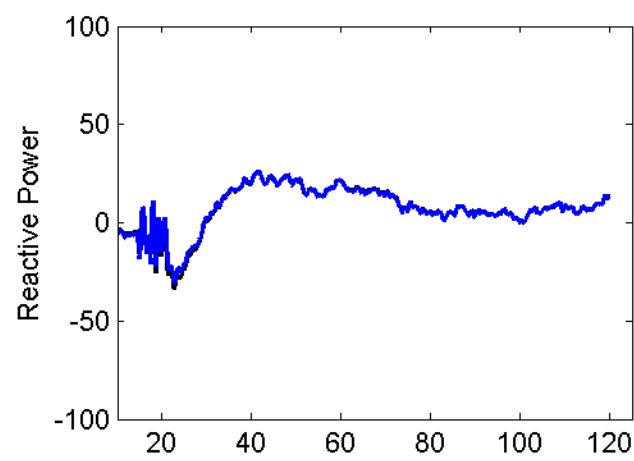
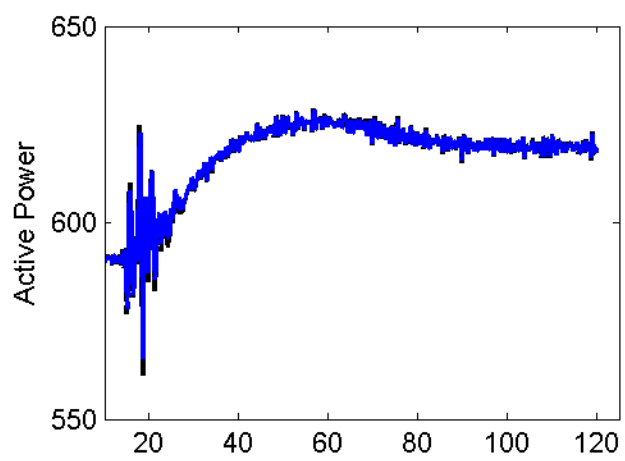
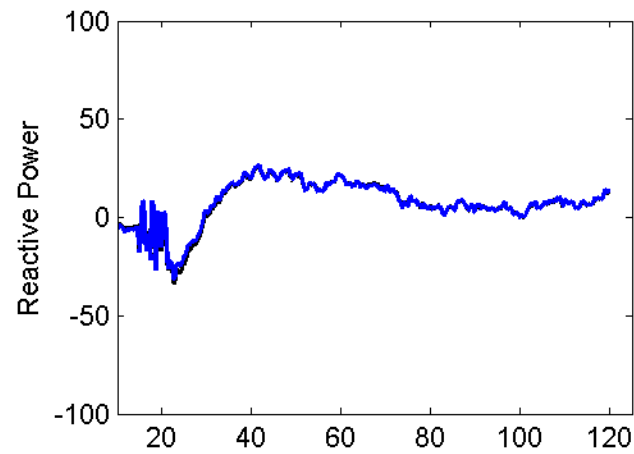
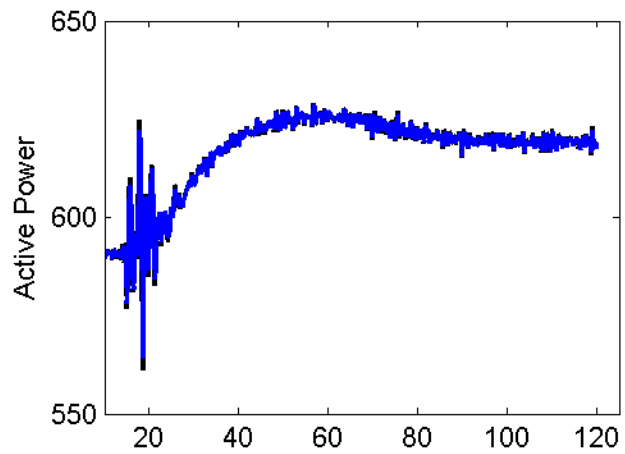

H	4.42	4.47
Xc	0.052	0.052
Ka	443	400
Kf	0.021	0.021
Tf	0.79	0.72
T5	12.6	12.6
Ks	8.23	8.26
Rp	0.045	0.045
Rt	0.46	0.40
Tr	1.82	2.02
Tw	1.76	2.00



Test Case Voltages

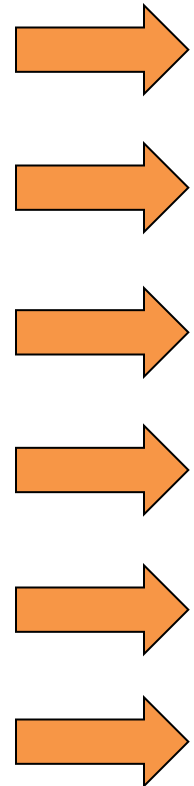
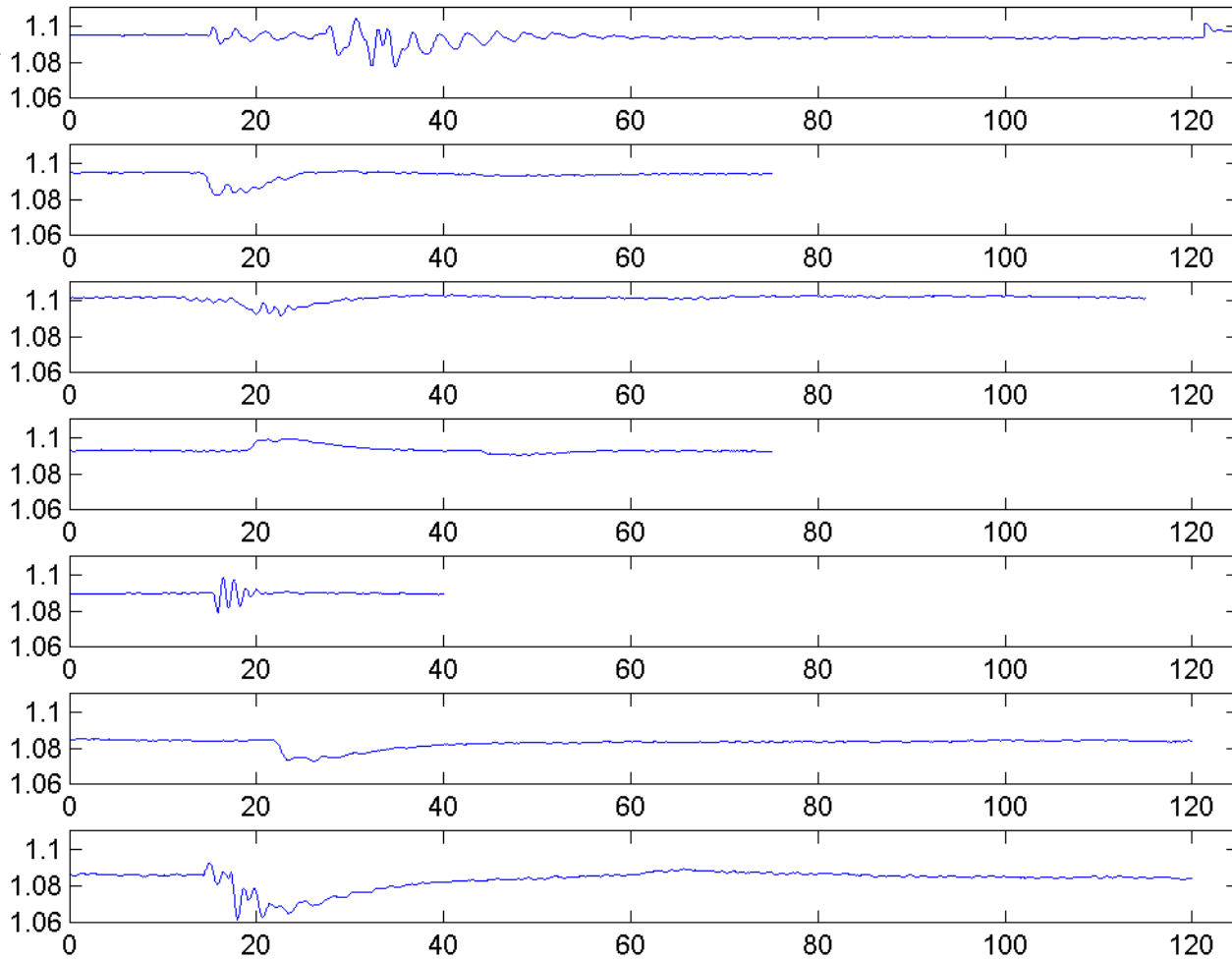
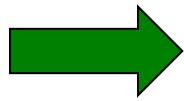



Training Signal 1

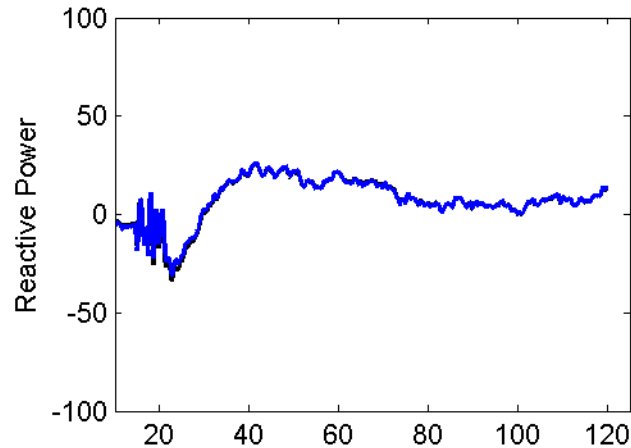
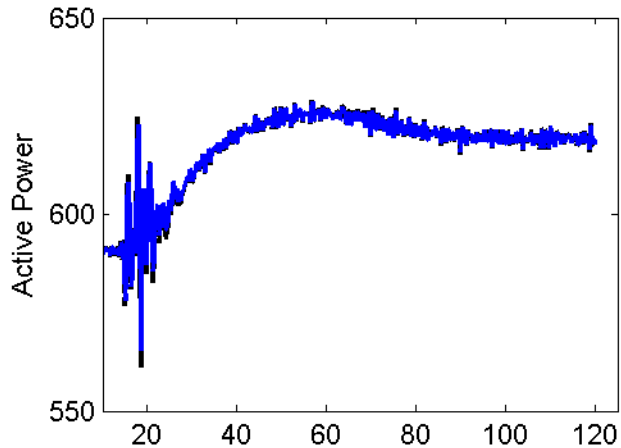
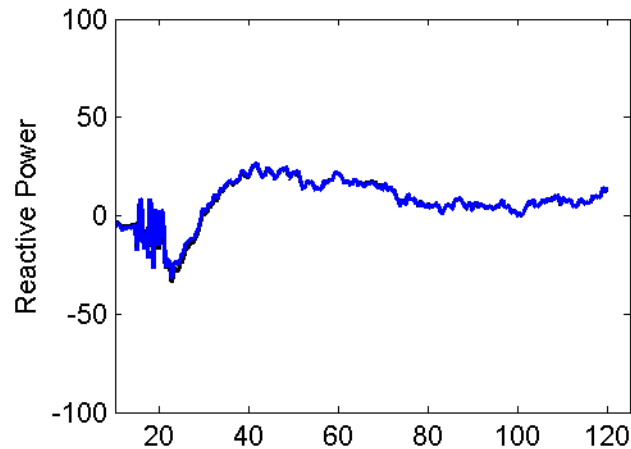
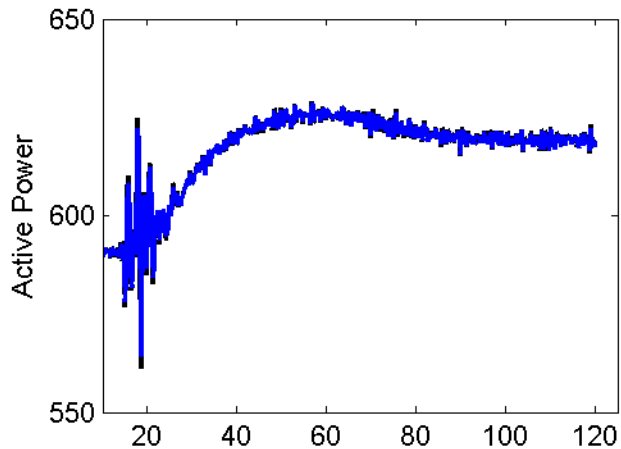

H	4.42	4.47
Xc	0.052	0.046
Ka	443	500
Kf	0.021	0.027
Tf	0.79	0.89
T5	12.6	12.2
Ks	8.23	8.58
Rp	0.045	0.045
Rt	0.46	0.32
Tr	1.82	2.61
Tw	1.76	2.04



Conclusions

- PMU data is absolutely valuable for affirming, refuting and recalibrating models.
- Engineering judgment is (still) required to understand models, to
 - know which knobs to turn in calibration, and how far,
 - Identify structural changes in the data.

Using Phasor System Data in RTDMS & PGDA to Validate System Response and Dynamic Models

Bharat Bhargava, Kevin Chen, Anamitra Pal



In Collaboration With
Juan Castaneda

Farroukh Habibi-Ashrafi



North American Synchro Phasor Initiative Meeting/Workshop

October 22, 2013, Chicago, Illinois

Model Validation Case Studies Using RTDMS and PGDA

- September 8, 2011 Pacific Southwest Blackout Simulation
 - Event simulated and compared with NERC/FERC report
- January 26, 2008 (HVDC Oscillations)
 - Compared with actual event files, simulation compares fairly well
 - Do see high frequency oscillations (2.3 Hz) in simulation, instead of 3.8-4.3 Hz observed in the real event
- Pacific Intertie (COI) Simulations
 - Loading COI to 4860, 5680 and 6370 MW (Static stress) and subjecting it to dynamic stress
 - Monitoring voltage and angle sensitivity at Malin substation

RTDMS and PGDA Overview for Simulations

- Real Time Dynamic Monitoring System (RTDMS) is used for visualization and Phasor Grid Dynamics Analyzer (PGDA) is used for detailed off-line analysis
- RTDMS typically takes C37.118 / 61850 high-speed synchro-phasor system data and can display multiple parameters important for operation of the power system
- PGDA takes multiple formats such as dst, comtrade, csv, synchro-phasor system data and supports detailed analysis of the system event
- For simulations, EPG developed capability to import csv file formats in both these programs
- These programs can now be used to visualize and analyze PSLF simulations by converting PSLF output data in to CSV files
- Simulated data can be compared with actual events and can be used for system model validation
- Extreme events can be simulated and run using RTDMS to train operators

Overview of Methodology to Validate System Response and Dynamic Models Using RTDMS and PGDA

- Perform simulations using PSLF – dynamic simulations typically 10 to 15 minutes
- Convert PSLF simulation data to CSV format using MATLAB
- PMU Simulator to stream CSV file data to RTDMS for visualization and validation
- Perform detailed offline analysis of simulated event using PGDA

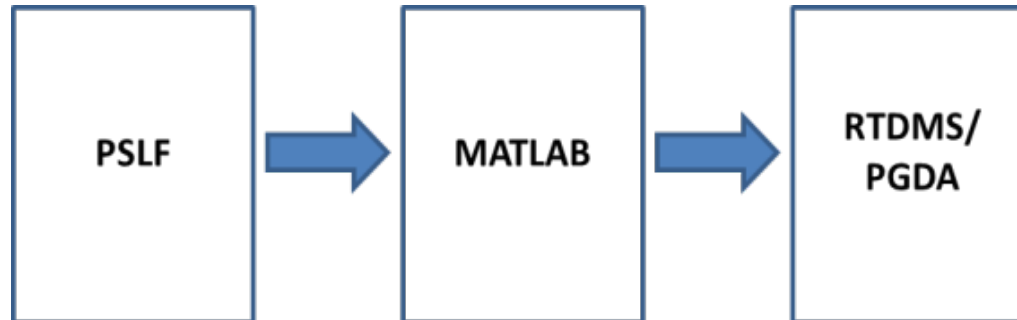

Methodology – Parameters Used in Visualization

■ Basic

- Voltage Magnitude
- Voltage Angle
- Frequency, df/dt
- Power
- Reactive Power

■ Advanced

- Modes of Oscillations and their Damping
- Voltage sensitivity (dV/dP_{100} – kV change per 100 MW)
- Angle sensitivity (dA/dP_{100} - degrees change per 100 MW)

Methodology – Parameters Used in Off-Line Analysis

■ Basic

- Voltage Magnitude
- Voltage Angle
- Frequency Transients
- Frequency Response
- Real Power
- Reactive Power

■ Advanced

- Oscillation and Damping
- Mode Meter – Ambient Oscillation Analysis
- Ring Down Analysis
- Spectral Analysis

Methodology Use Cases

PSLF Simulation capability is used to:

- Compare a real event with the simulated event to validate simulation and models
 - Once a good match is obtained, the case can be used to examine event details
- RTDMS is used for wide-area visualization of the simulation results
 - Wide-area view can be used to identify stress points and locations
- Visualization and Off-Line Analysis can be used for:
 - Training operators by simulating extreme system events
 - Setting and Validating Alarm/Alert levels for use in real-time monitoring
 - Conducting contingency analysis and testing established thresholds for Alert/Alarm

September 8, 2011 Pacific Southwest Blackout Event Simulation

Event Description:

- Event took about 12-minutes
- Complete event simulated using PSLF
- Compared with the NERC/FERC report
- Simulation matches very closely
- Simulation replayed in RTDMS and analyzed using PGDA for validation
- EPG is working with SCE to simulate the event using their Real Time Digital Simulator (RTDS)
- Sequence of events in simulation includes:
 - Outage of North Gila-Hassayampa line
 - Outage of IID transformers
 - Load drop in IID and CFE
 - Loss of CFE and IID generation
 - Separation of SDGE at San Onofre Power Plant

Comparison of Actual (NERC/FERC Report) and Simulated September 8, 2011 Event

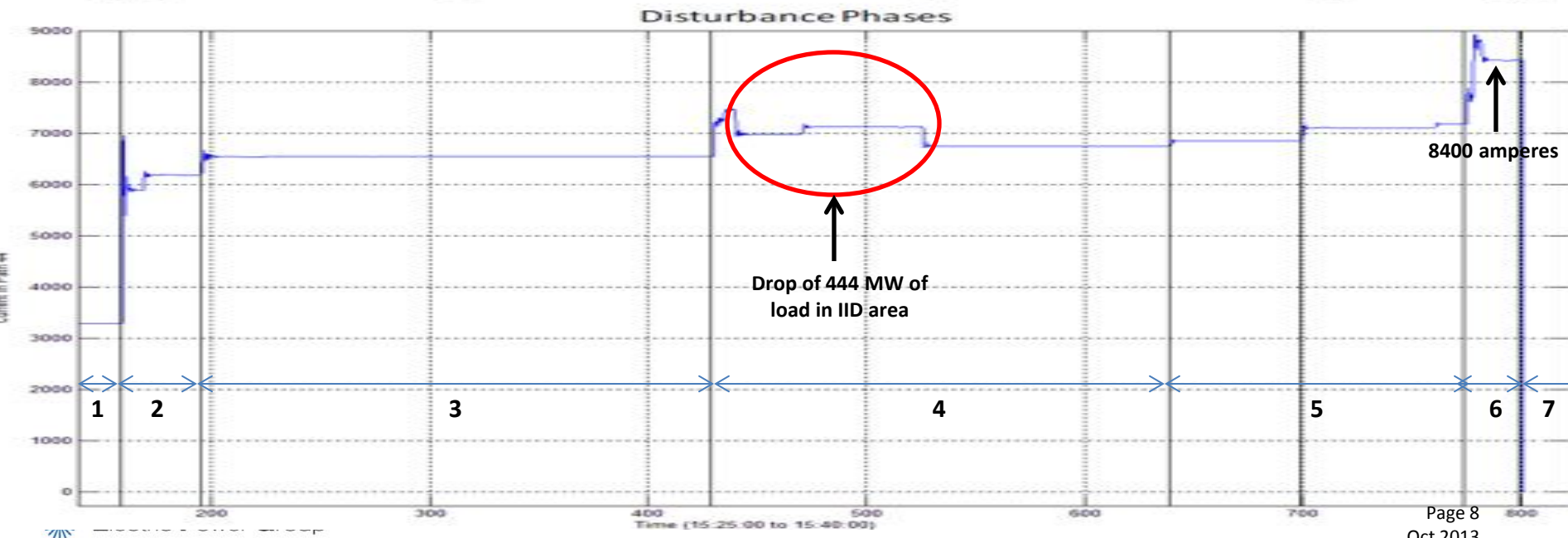
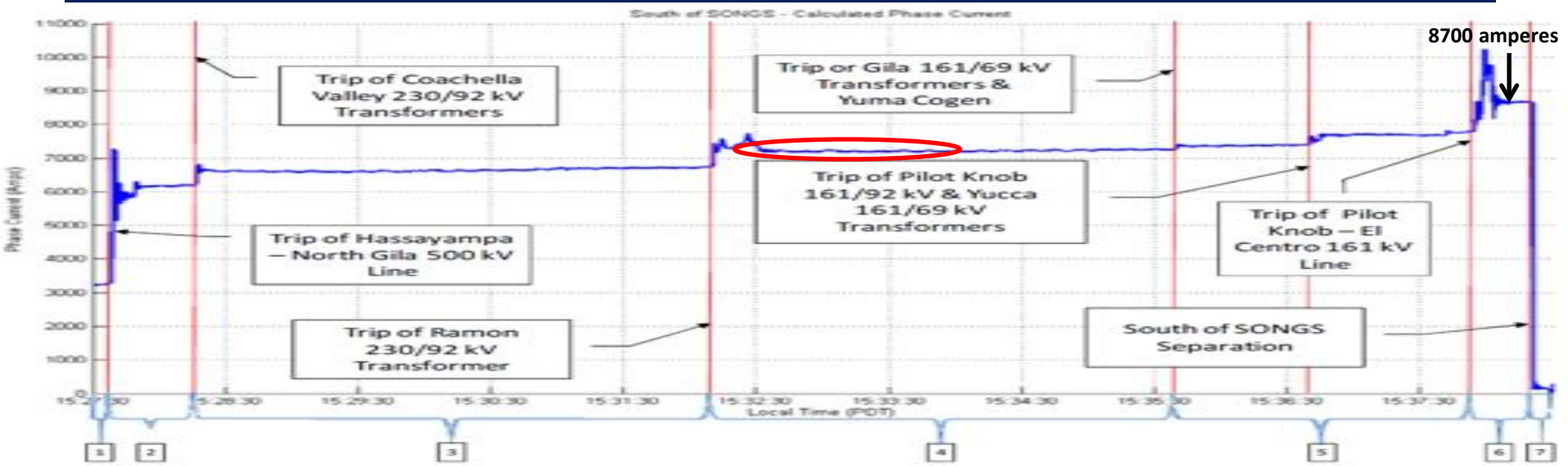

Visualization of San Diego Blackout Simulation (After Hassayampa-N.Gila Line Trip) - Replay

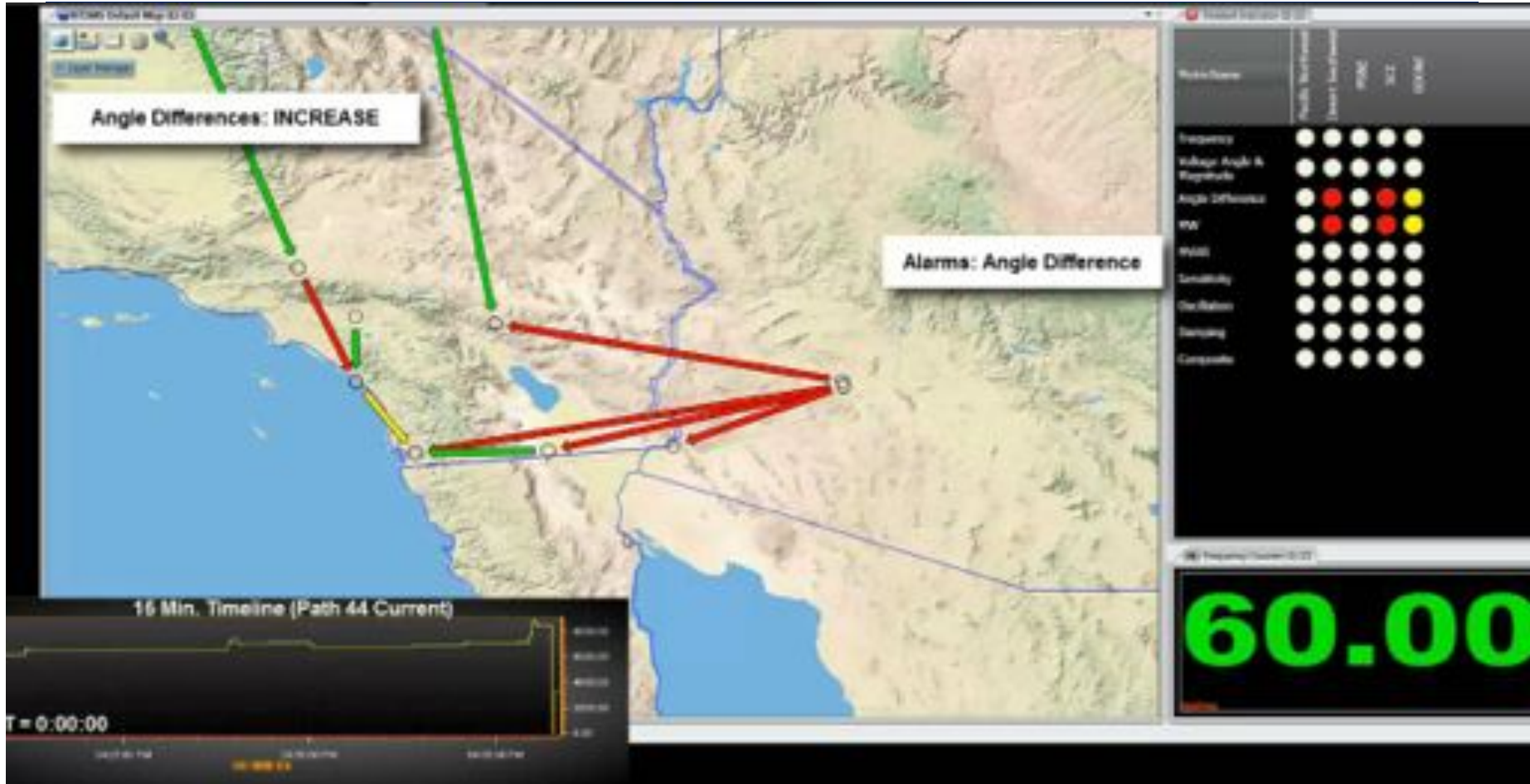

Simulation File Replay Showing Angle Differences Just Before Separation - Phase V of Blackout



Oscillations Caused by PDCI Controls on January 26, 2008

Event Description:

- Oscillations caused by the DC system control at Celilo substation when the three 525/230 kV transformers at Big Eddy – near Celilo tripped
- High frequency oscillations occurred at HVDC 230 kV bus at Celilo and Sylmar – the two ends of the PDCI line.
- Oscillation frequency varied between 3.6 to 4.4 Hz.
- Damping dropped to 1-2 %
- Simulation shows high frequency oscillations occurring on Power, voltage and frequency at Big Eddy and Sylmar
- Oscillation frequency in simulations is lower (About 2.3 Hz)
- PGDA shows oscillation frequency (2.3 Hz) and damping (1-2 %)

Large Sustained Frequency Oscillations Occurring at Celilo and Sylmar (Actual Event)

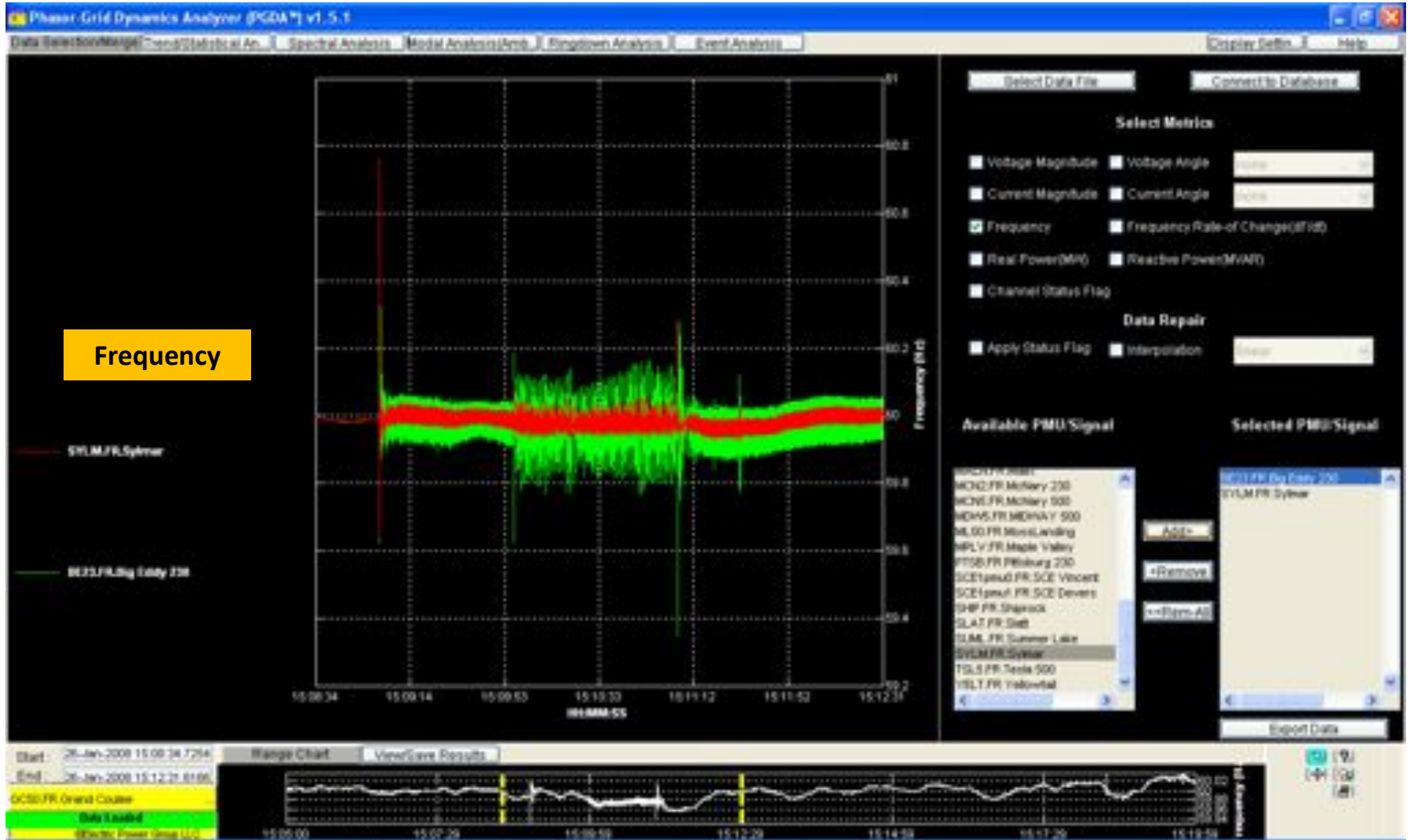

Large Sustained Frequency Oscillations Occurring in the System (Actual Event)



Large Sustained Frequency Oscillations at Big Eddy, Sylmar and Tesla Substation (Simulations)

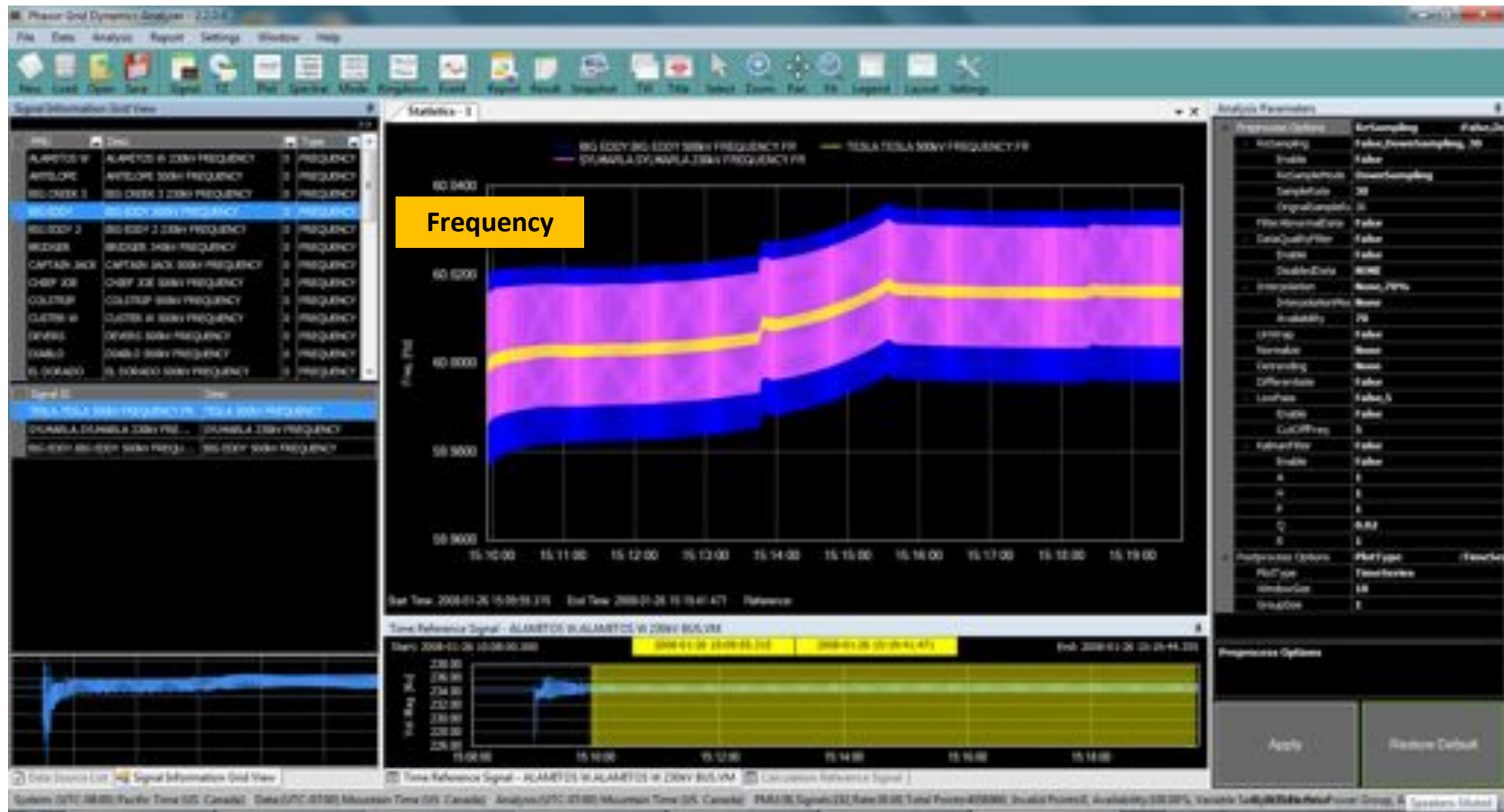

Mode Meter Analysis of DC System Oscillations Using PGDA (Simulations)



Simulation – Stressing Pacific Intertie (COI) to 6370 MW

Simulation Description:

- Highly stressed 2011 Heavy Summer Base case
- System stressed (Static- in power flow case)
 - COI at 4860 MW
 - COI at 5680 MW
 - COI 6370 MW
- Angle difference between Grand Coulee – Devers
- Wide Area visualization shows Malin voltage is very sensitive to COI loading

COI Loading	Grand Coulee – Devers Angle	Malin Bus Voltage
4860 MW	88 Degrees	540 kV
5680 MW	108 degrees	520 kV
6370 MW	129 degrees	493 kV

As seen in the above table, the Voltage at Malin substation sags as the COI is loaded and Angle difference between Grand Coulee and Devers increases

Power and Voltage Plot at Malin Substation

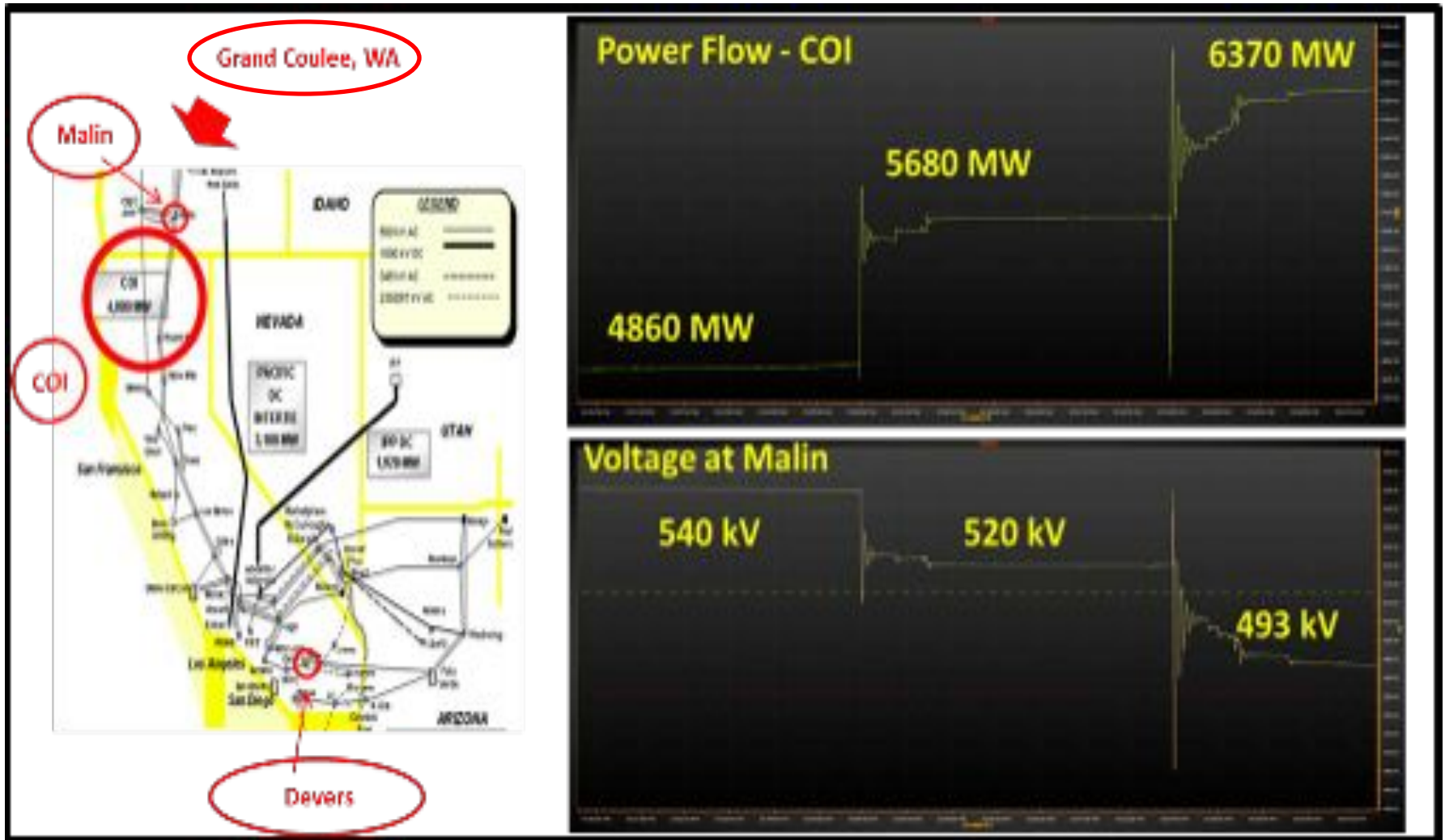

PV Curve for the COI Stressed Case Simulation

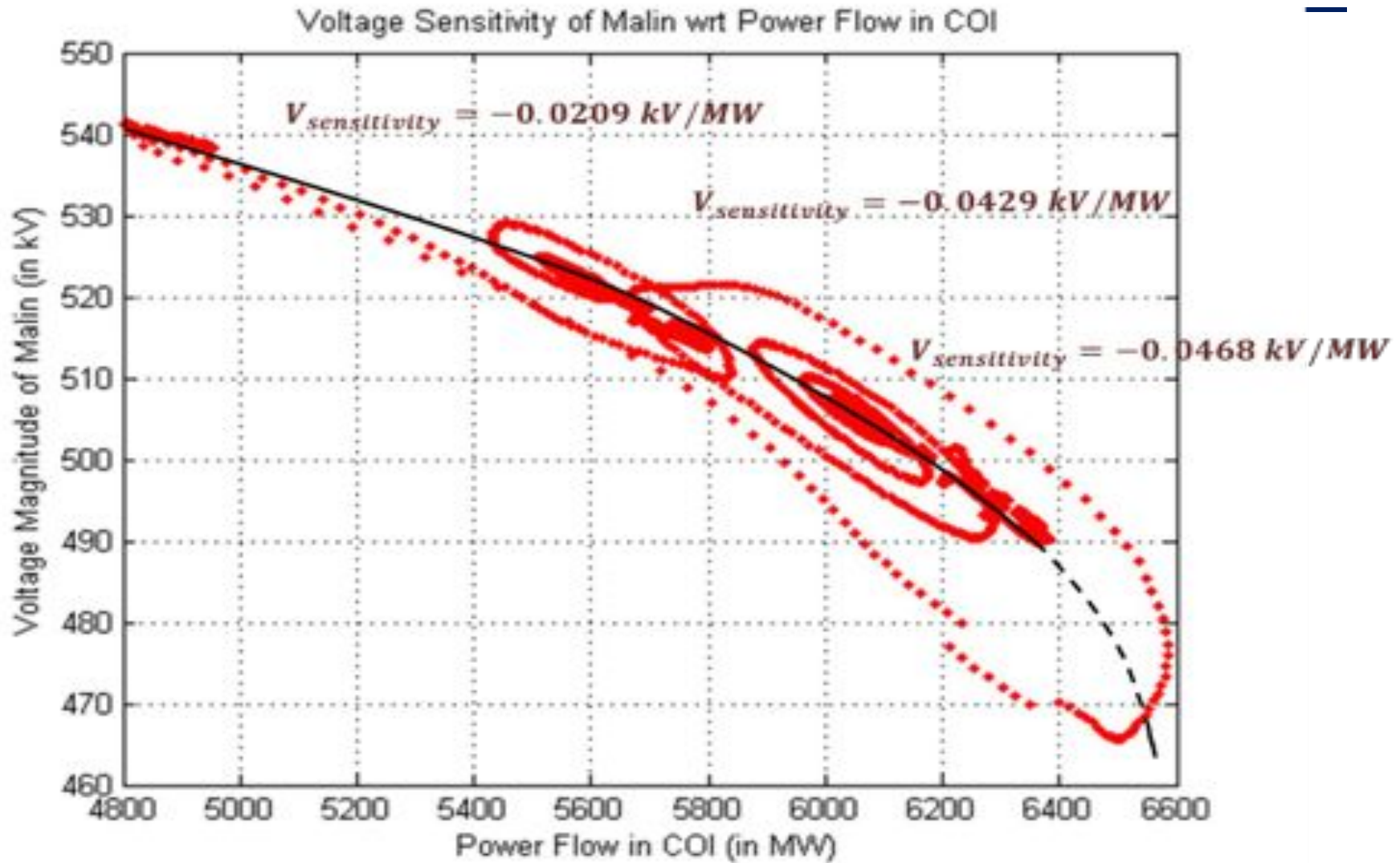

Monitoring Voltage Sensitivity Using RTDMS

WECC Simulation Case: California - Oregon Intertie Stress Test

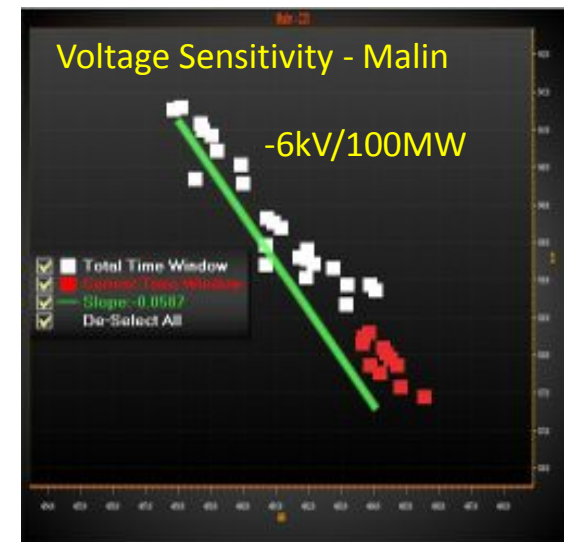
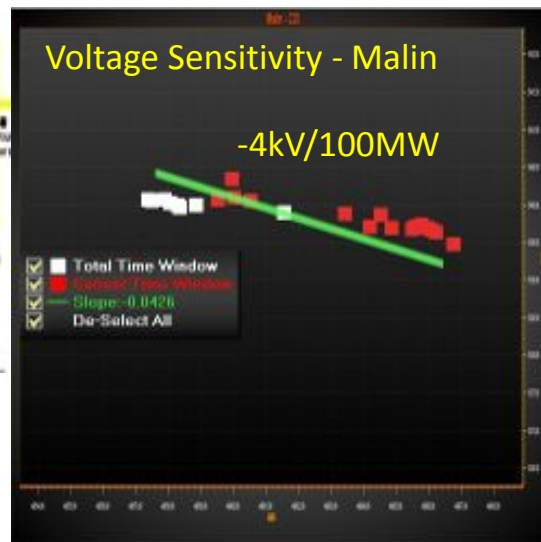
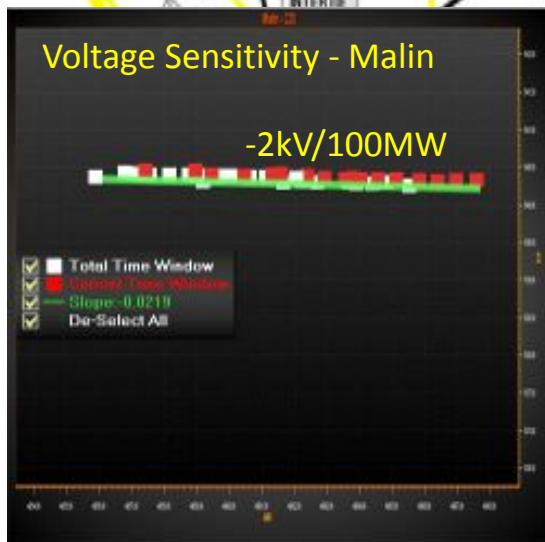
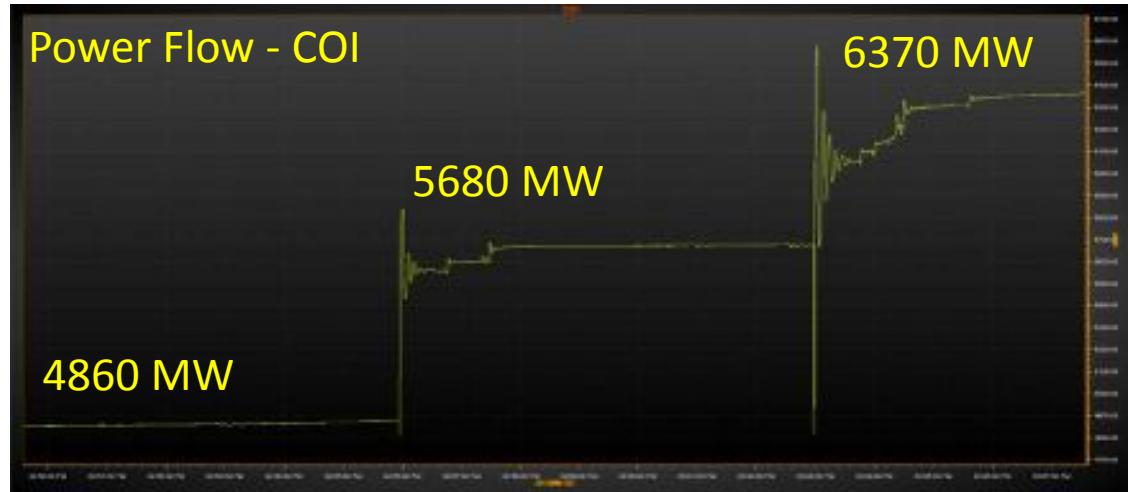
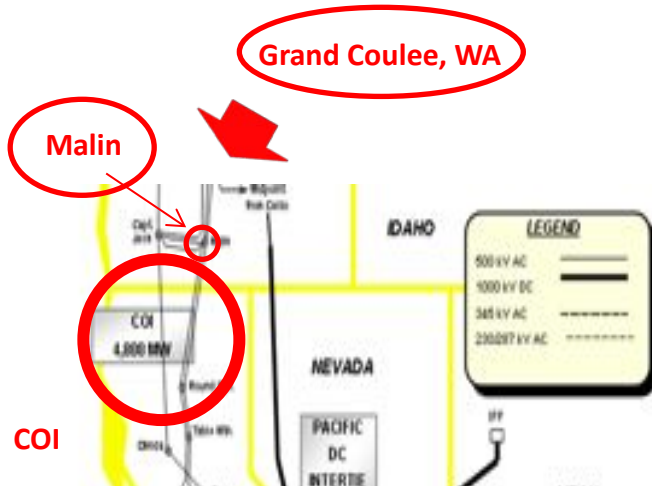

Power Flow at Malin and Angle Difference Between Grand Coulee and Devers

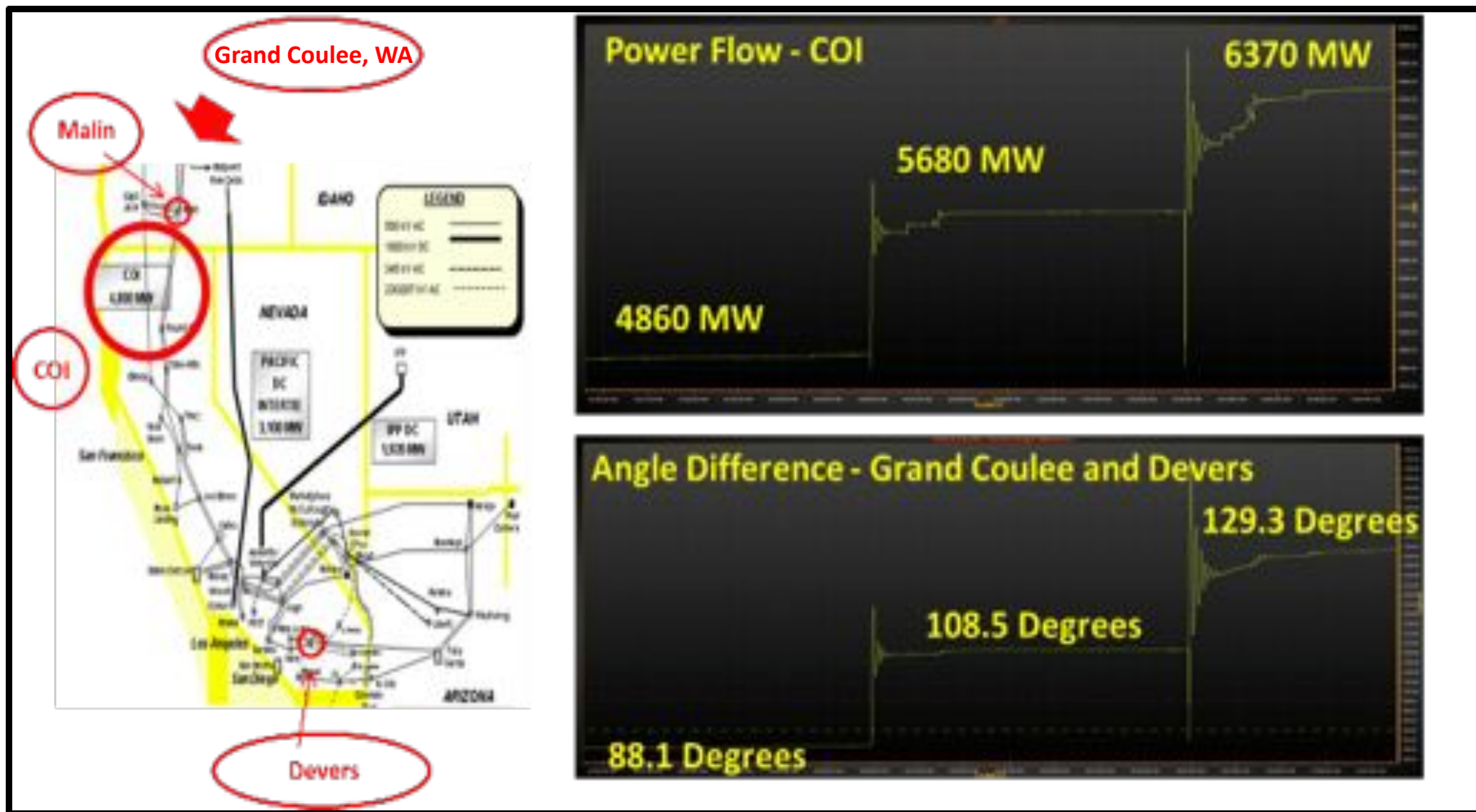

Monitored Angle Differences & Alarms for the Stressed COI Case

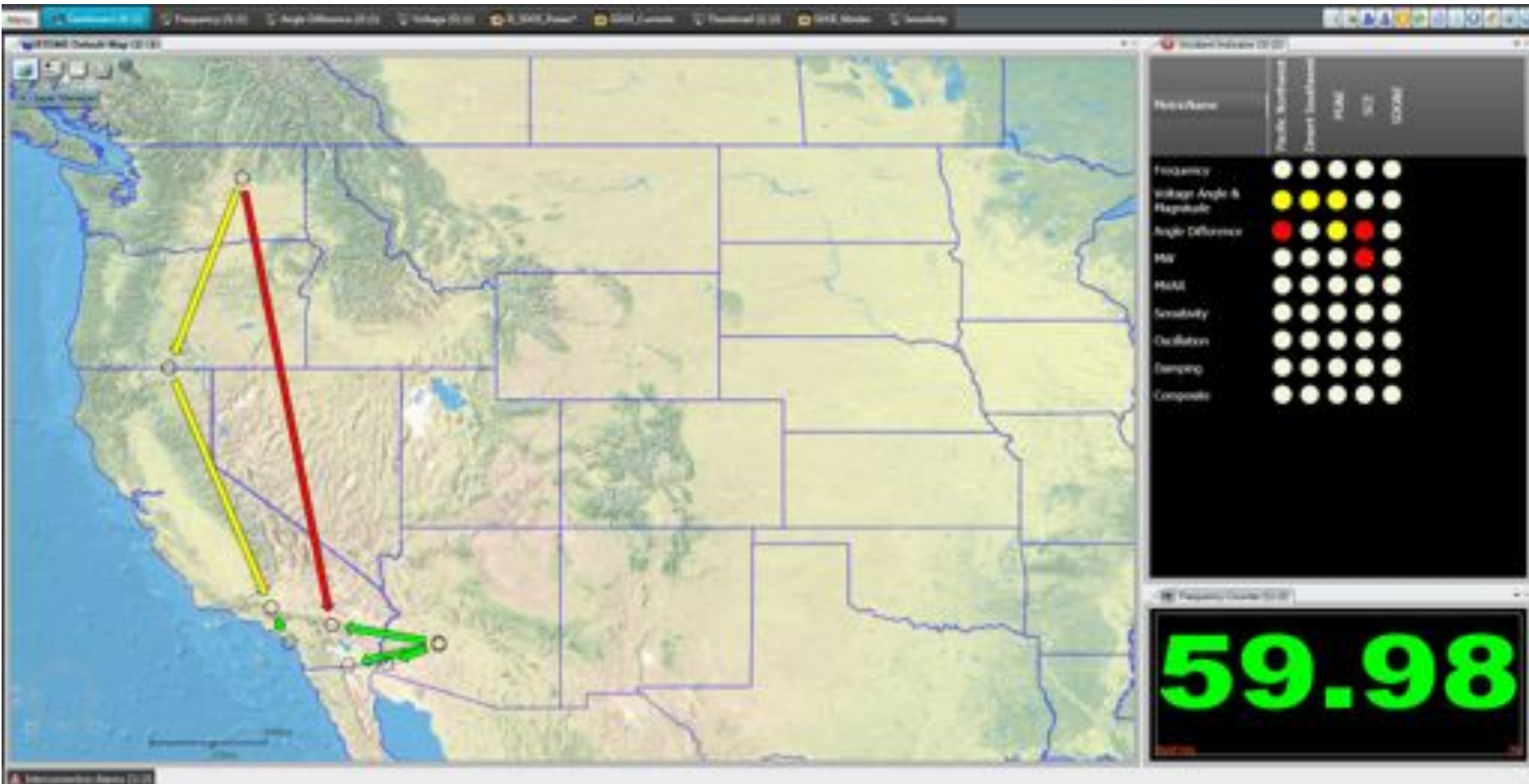

Conclusions / Summary

- Simulations were used for several different events
- Simulations can be conducted for actual disturbances/extreme events to compare and validate models
- RTDMS and PGDA were used to visualize PSLF simulated files and perform off line analysis
- Simulations can be used for model validation and operator training
- Simulated event replay - 2-minute [video](#)

Thank You!

For questions, please contact **Bharat Bhargava**
Bhargava@ElectricPowerGroup.com



Electric **P**ower **G**roup

201 S. Lake Ave., Suite 400

Pasadena, CA 91101

(626)685-2015

www.ElectricPowerGroup.com



System Model Validation

DOE NASPI Workshop

October 2013

Composite Load Model (CMPLDW)

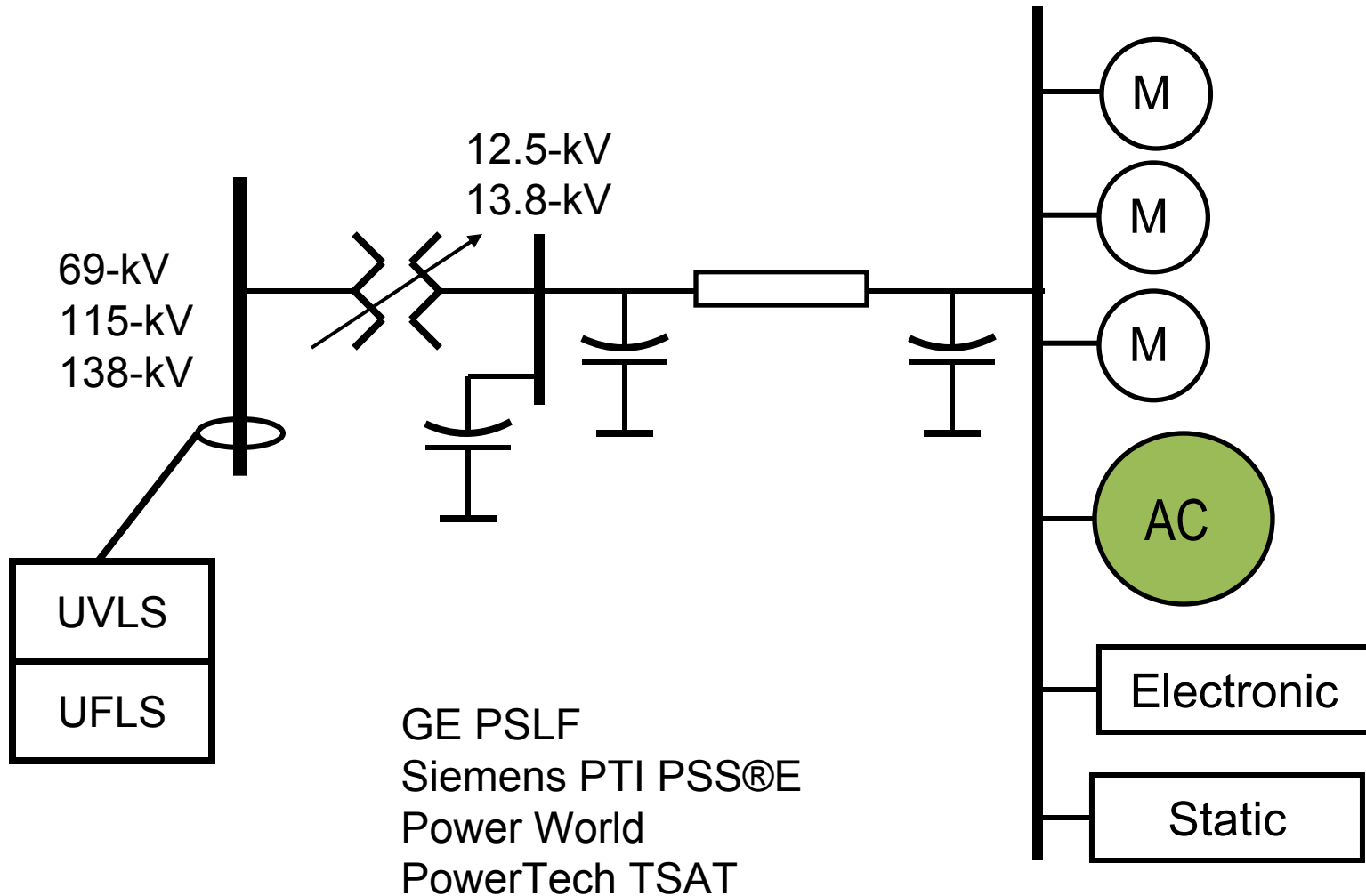

Where we are now ...

- WECC Composite load model version 1 is implemented in GE PSLF and Siemens PTI PSS[®]E, similar models exist in Power World, Power Tech TSAT
 - Improvements to LTC models are requested in GE PSLF
 - Minor modifications are suggested for PSS[®]E Model
- Default sets are developed:
 - 12 climate zones in WECC,
 - four types of feeders (RES, COM, MIX, RAG)
 - Summer, winter and shoulder conditions
- Base cases will have LIDs populated

Climate Zones in the West



- NWC – Northwest coast
- NWV – Northwest valley
- NWI – Northwest inland
- RMN – Rocky mountain
- NCC – N. Calif. coast
- NCV – N. Calif. Valley
- NCI – N. Calif. Inland
- HID – High desert
- SCC – S. Calif. coast
- SCV – S. Calif. Valley
- SCI – S. Calif. Inland
- DSW – Desert southwest

WECC Load Composition Model

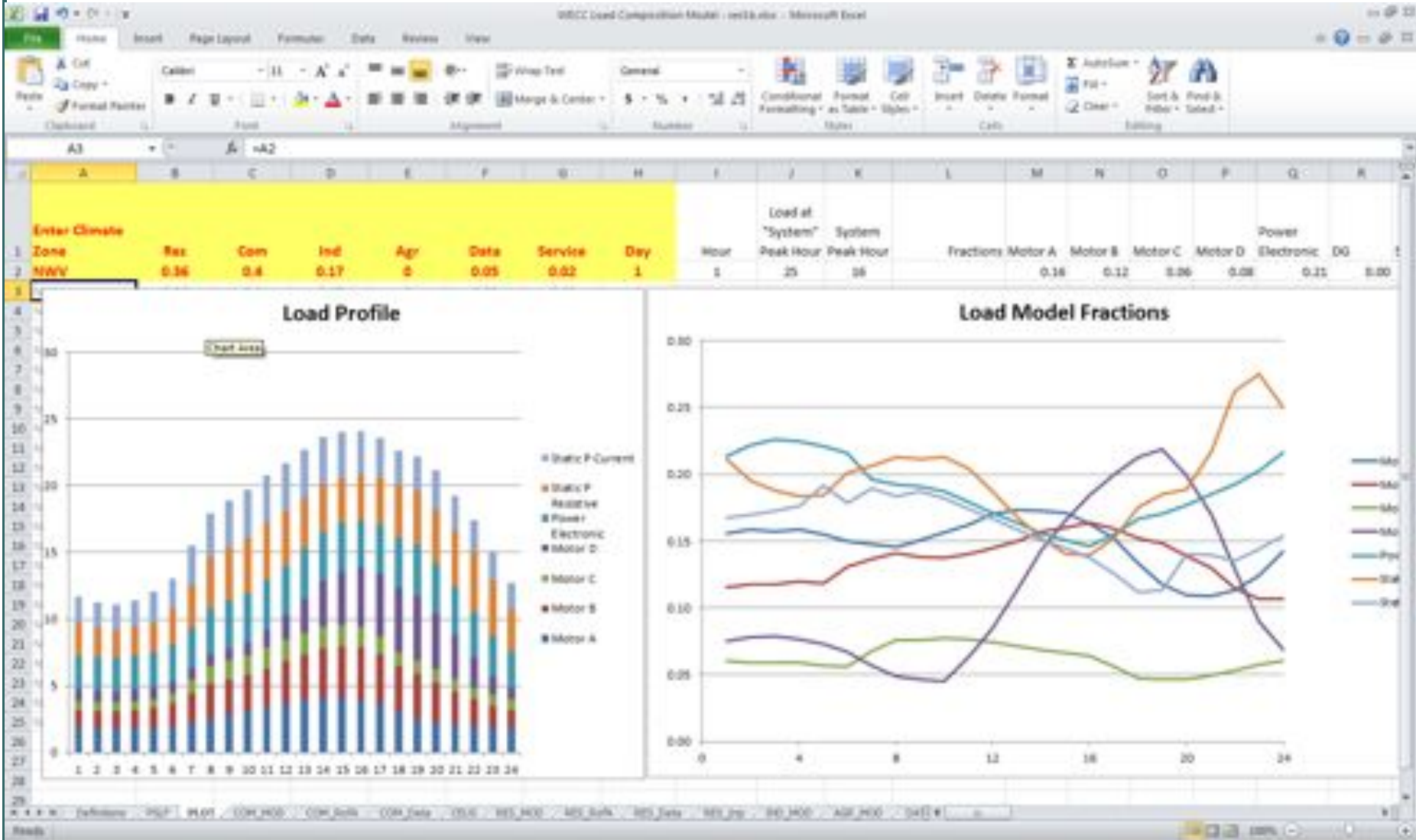

Load Model Validation Studies

August 4, 2000 Oscillation – Old Model

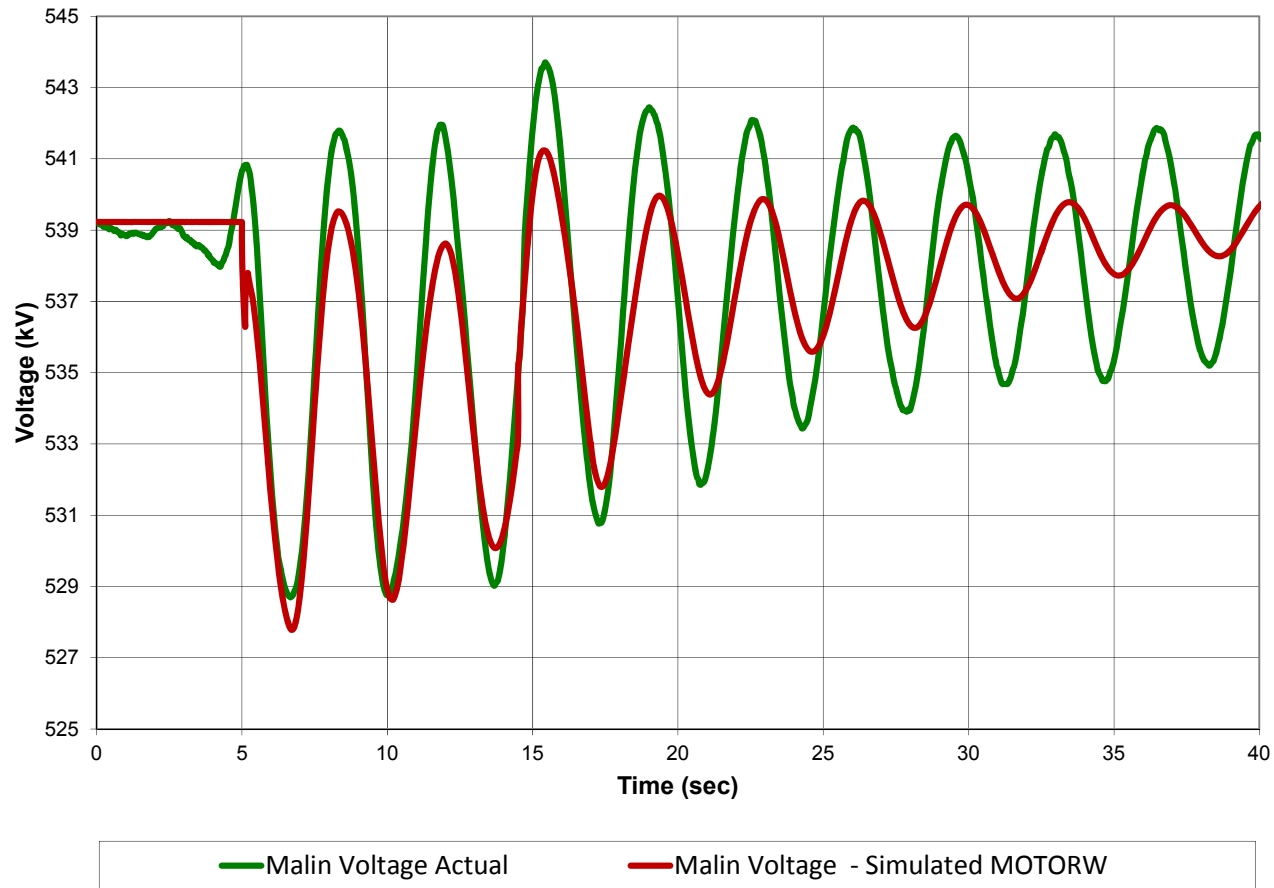

August 4, 2000 Oscillation - CMPLDW

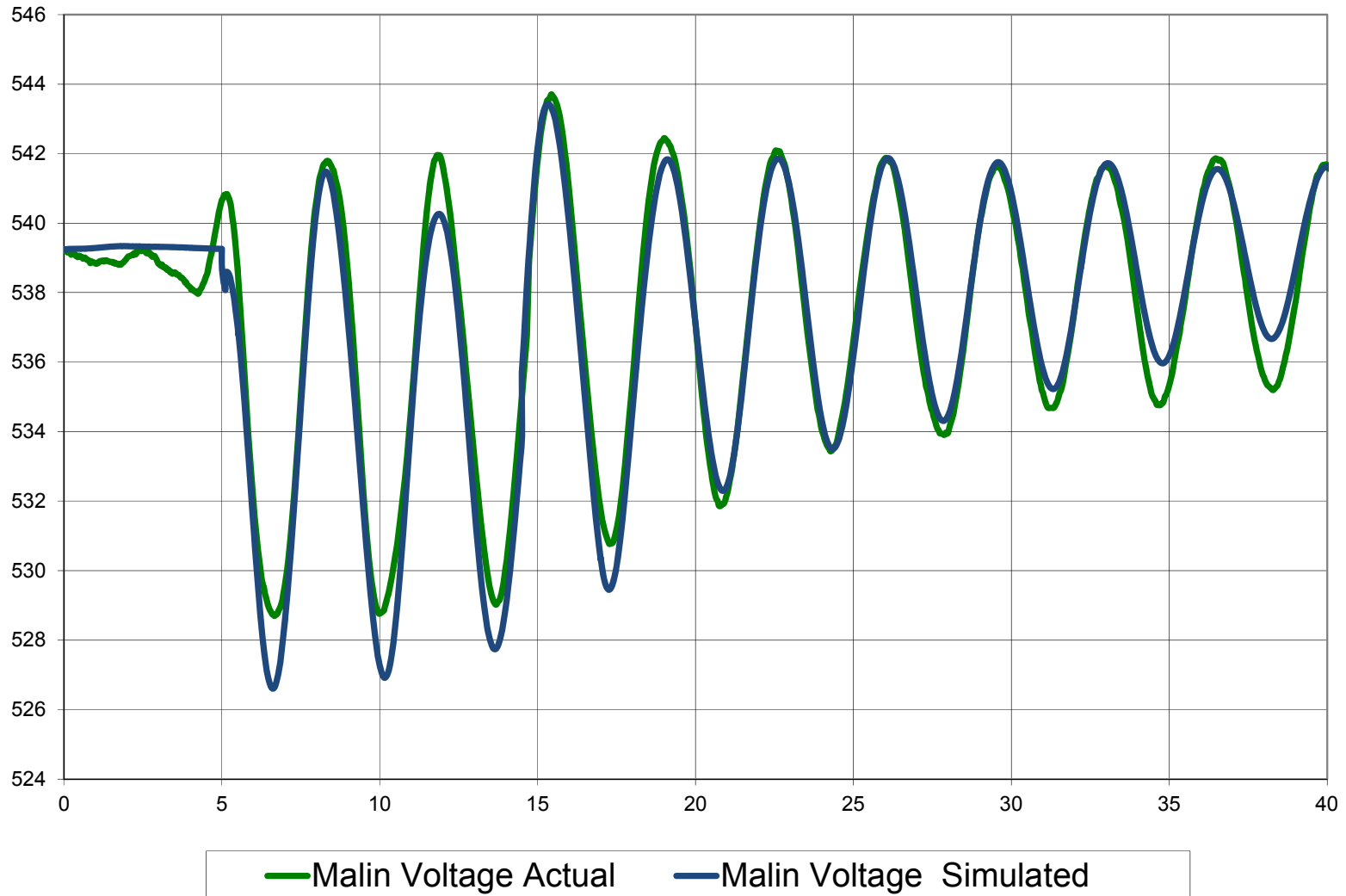

Reproducing Delayed Voltage Recovery Events with CMPLDW

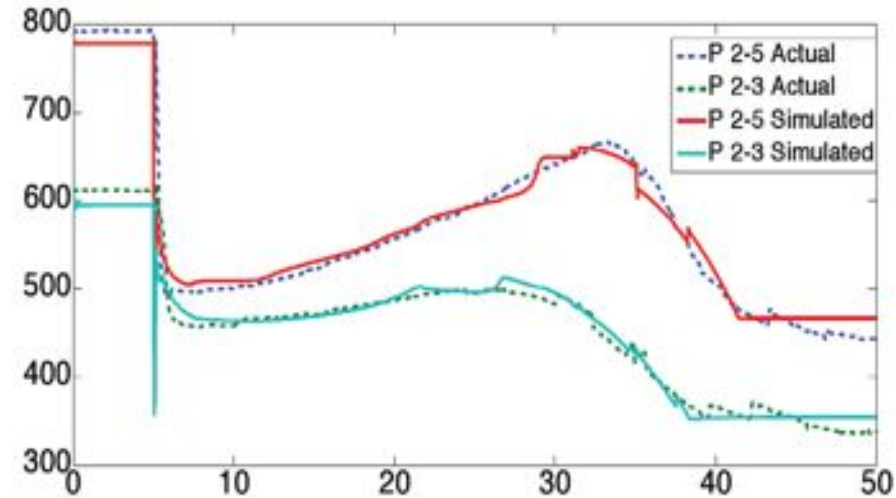
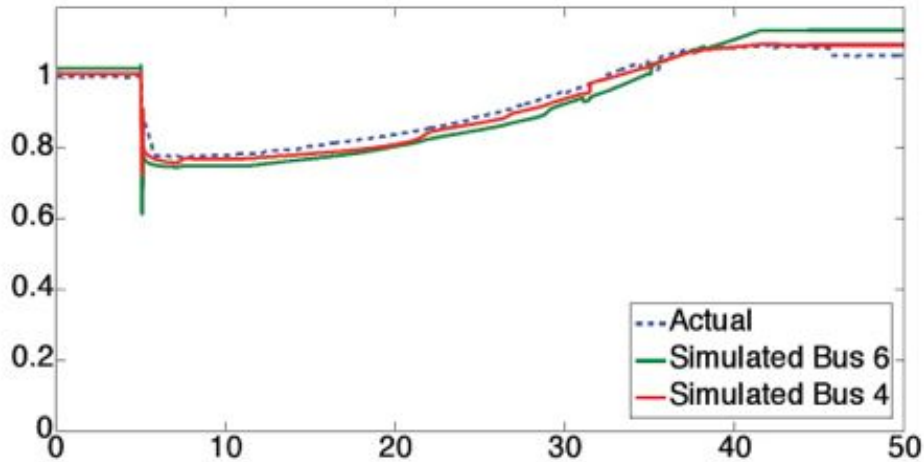

Simulations of delayed voltage recovery event due to air-conditioner stalling
Models can be tuned to reproduce historic events reasonably well

Done by Alex Borden and Bernard Lesieutre at University of Wisconsin

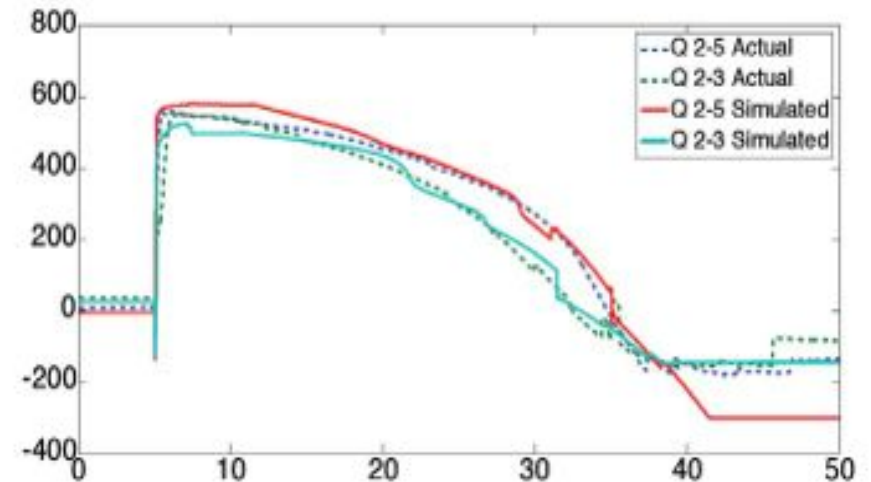

Load Modeling – Setting Expectations

- We can now achieve the great accuracy with generator models:
 - We model physical equipment that is well defined and under our control
- We will never be able to achieve a comparable level of accuracy with load models
 - Yes, we can tune load models to accurately reproduce and explain past events
 - But, Load models is only capable of predicting the future load response only in principle, and not in detail

Data for Load Model Validation

- Positive sequence data is no longer sufficient
- Loads are connected to individual phases
- Behavior of loads is now dependent on point on wave phenomenon
- CERTS and SCE deployed a number of Power Quality monitors

Data for Load Model Validation

