

NERC

NORTH AMERICAN ELECTRIC
RELIABILITY CORPORATION

Real-Time Application of Synchrophasors for Improving Reliability

to ensure
the reliability of the
bulk power system

116-390 Village Blvd., Princeton, NJ 08540
609.452.8060 | 609.452.9550 fax
www.nerc.com

List of Contributors

Mahendra Patel (PJM), RAPIR Chair
Sandy Aivaliotis (Nexans)
Eric Allen (NERC)
Dave Bakken (Washington State University)
Lisa Beard (Quanta Technologies)
Vivek Bhaman (Electric Power Group)
Navin Bhatt (AEP)
Terry Bilke (Midwest ISO)
Vikram Budhraj (EPG)
Tom Bowe (PJM)
Ritchie Carroll (Grid Protection Alliance)
Jeff Dagle (Pacific Northwest Lab)
Scott Dahman (PowerWorld)
Jay Giri (Areva T&D)
Dave Hilt (NERC)
Sam Holeman (Duke)
John Hauer (Pacific Northwest Lab)
Zhenyu Huang (Pacific Northwest Lab)
Stan Johnson (NERC)
Tony Johnson (SCE)
Larry Kezele (NERC)
Jim Kleitsch (ATC)
Dmitry Kosterev (BPA)
Mark Laufenberg (PowerWorld)
Elizabeth Merlucci (NERC)
Paul Myrda (EPRI)
Philip Overholt (US DOE)
Russell Robertson (Grid Protection Alliance)
Ron Stelmak (The Valley Group)
John Sullivan (Ameren)
Alison Silverstein (NASPI Project Manager)
Dan Trudnowski (Montana Tech)
Ebrahim Vaahedi (BCTC)
Marianna Vaiman (VR Energy)
Lee Wang (Grid Sentinel)
Don Watkins (BPA)
Pei Zhang (EPRI)

Table of Contents

List of Contributors.....	2
Executive Summary and Next Steps.....	5
Chapter 1 – Introduction and Overview.....	7
1.0 Introduction	7
1.1 Synchrophasors	9
1.2 Report Outline	10
1.3 Background	11
1.4 The Value and Promise of Synchrophasor Technology.....	11
1.5 Synchrophasor System Deployment	16
1.6 Conclusions	19
Chapter 2 — What Is Technology Readiness for Power System Operations?.....	20
2.0 Operations Use Requirements Vary	20
2.1 What Is Production-Grade?.....	21
2.2 Dimensions and Potential Requirements for a Production-Grade System.....	21
Chapter 3 — Synchrophasor Data Systems	24
3.1 Phasor Measurement Units and GPS	24
3.2 PMU Measurements and Sampling Rates.....	28
3.3 Phasor Data Concentrators	29
3.4 Data Storage	31
3.5 The Need for Redundancy	32
3.6 NASPInet and Synchrophasor Network Architecture.....	33
3.7 Security.....	35
3.8 Technical Standards and Interoperability for Phasor Systems.....	35
Chapter 4 — Phasor Data Applications and Grid Reliability	37
4.0 Applications Overview.....	37
4.1 Phasor Data Use for Real-Time Operations.....	38
4.1.1 Wide-area situational awareness.....	38
4.1.2 Frequency stability monitoring and trending.....	44
4.1.3 Power oscillations	44
4.1.4 Voltage monitoring and trending.....	47
4.1.5 Alarming and setting System Operating Limits; Event detection and avoidance ..	49
4.1.6 Resource integration	49
4.1.7 State estimation.....	50
4.1.8 Dynamic line ratings and congestion management	51
4.1.9 Outage restoration.....	52
4.1.10 Operations planning.....	54
4.2 Phasor Data Use for Planning (off-line applications).....	55
4.2.1 Baselining power system performance	55
4.2.2 Event analysis	56
4.2.3 Static system model calibration and validation	57
4.2.4 Dynamic system model calibration and validation.....	58
4.2.5 Power Plant Model Validation.....	59
4.2.6 Load Characterization.....	60

4.2.7	Special protection schemes and islanding.....	61
4.2.8	Primary Frequency (Governing) Response.....	62
4.3	Wide-Area Controls	63
4.4	Applications and Data Classes	65
4.5	Phasor Applications, Alarm-Setting and Operator Training.....	66
Chapter 5 — Conclusions, Recommendations and the Path Forward.....		69
5.1	Synchrophasor Technology Priorities for Operators.....	69
5.2	What’s Production-Grade Today?.....	70
5.3	Recommendations and the Path Forward.....	70
5.3.1	Hardware and software needs	73
5.3.2	Research.....	73
5.3.3	Learning from the ARRA SGIG and demonstration grants.....	74
5.3.4	Technology standards, performance and interoperability testing	74
5.3.5	Security	75
5.3.6	Putting phasor technology into NERC operating and planning standards.....	75
5.3.7	NERC’s role.....	76
5.4	What else is needed for phasor technology to succeed?	77

Executive Summary and Next Steps

This report reviews the many ways that synchrophasor technology can be used to support real-time and off-line activities to enhance the reliable operations of the bulk power system. The report has been prepared at the request of the NERC's Operating Committee.

Synchrophasor technology can help deliver better real-time tools that enhance system operators' situational awareness. A synchrophasor system -- with wide deployment of phasor measurement units and dedicated high-speed communications to collect and deliver synchronized high-speed grid condition data, along with analytics and other advanced on-line dynamic security assessment and control applications -- will improve real-time situational awareness and decision support tools to enhance system reliability. Synchrophasor measurements can also be used to improve component and system models for both on-line and off-line network analysis to assess system security and adequacy to withstand expected contingencies. But to realize this great potential, each interconnection must deploy a highly reliable, secure and robust synchrophasor data measurement and collection system and develop a suite of validated, highly available, robust and trustworthy analytical applications. Last, organizational support processes and appropriate training for use of the advanced technologies will need to be developed and implemented.

Synchrophasor data can be used to enhance grid reliability for both real-time operations and off-line planning applications, as listed below; this report explains the purpose and benefits of each application, assesses its readiness for use, and offers references for further information:

Real-time operations applications

- Wide-area situational awareness
- Frequency stability monitoring and trending
- Power oscillation monitoring
- Voltage monitoring and trending
- Alarming and setting system operating limits, event detection and avoidance
- Resource integration
- State estimation
- Dynamic line ratings and congestion management
- Outage restoration
- Operations planning

Planning and off-line applications

- Baseline power system performance
- Event analysis
- Static system model calibration and validation
- Dynamic system model calibration and validation
- Power plant model validation
- Load characterization
- Special protection schemes and islanding
- Primary frequency (governing) response

Wide area controls

Synchrophasor technology is changing rapidly, sparked in large part to major investments in phasor system deployment by the electric industry with matching funds from the U.S. Department of Energy's Smart Grid Investment and Demonstration Grants. Eleven grants for synchrophasor technology, following seven years of DOE R&D investments in phasor technology devices and applications, will add almost 1,000 new PMUs onto the grid in every U.S. interconnection, expansive new phasor data communications networks, and implementation of many real-time and planning applications to use these data. The SGIG awardees are working with the North American SynchroPhasor Initiative, a voluntary collaboration between industry, vendors, academics, NERC and DOE, to facilitate coordination, shared learning, problem-solving and accelerated standards development to enhance project success. By the time these projects conclude in 2014, several of these applications should have become production-grade and fully accepted in control rooms across the nation.

The long-term challenge for synchrophasor technology is to prove its value for operations and planning, to justify continued industry investment and ownership in production-grade, fully utilized systems. The RAPIR team offers several recommendations for near-term industry priorities and actions to advance this goal:

- The NERC Operating Committee and Planning Committee should receive regular briefings on successful applications of synchrophasor technology.
- Establish a library of grid disturbances and events, characterized in phasor data, to be used for analysis and training resources for operators and planners.
- Develop ten operator training models built around these system events.
- Understand and improve phasor data availability and quality and develop data validation methods and tools.
- Undertake and complete baselining analysis, using actual synchrophasor data, for every interconnection, to serve as the foundation for event detection, alarm-setting, and most other key real-time operations applications.
- Continue and complete interoperability standards development and adoption.
- Develop consensus functional specifications and testing protocols for Phasor Measurement Units and Phasor Data Concentrators.
- Develop and use naming and data format conventions for phasor data and devices.
- Expand the use of phasor data to validate and calibrate system and asset models.
- Develop goals, guidelines and tests for interoperability of inter-area, inter-party phasor system communications and data, and use them to support communications system implementation.
- Adopt methods for phasor data-sharing and protection.

Chapter 1 – Introduction and Overview

1.0 Introduction

This report reviews the many ways that synchrophasor technology can be used to support real-time and off-line activities to enhance the reliable operations of the bulk power system. The report has been prepared at the request of the NERC’s Operating Committee, following earlier work by NERC’s Real-Time Tools Best Practices Task Force.

NERC’s Real-Time Tools Best Practices Task Force (RTBPTF) in its 2008 report called for a number of “minimum acceptable capabilities and best practices for real-time tools necessary to ensure reliable electric system operation and reliability coordination.” Based on extensive surveys and analysis, the RTBPTF recommended that reliability coordinators and transmission operators should have five mandatory real-time tools (with appropriate performance and availability metrics and maintenance practices): telemetry data systems, alarm tools, network topology processors, state estimators, and contingency analysis. Furthermore, there should be standards and guidelines for enhanced operator situational awareness practices, including power flow simulations, conservative operations plans, load-shed capability awareness, critical applications and facilities monitoring, and visualization techniques.¹

The RTBPTF seeks to ensure, “that accurate information on current system conditions, including the likely effects of future contingencies, is continuously available in a form that allows operators to quickly grasp and fully understand actual operating conditions and take corrective action when necessary to maintain or restore reliable operations.”² They explain that real-time tools “are fundamental to operators’ situational awareness and ability to take prompt, effective corrective action. However, the quality of information supplied by these tools depends on the quality of telemetry and other real-time data as well as on situational awareness practices, system modeling practices, and tool maintenance and availability.”³

For planning, the RTBPTF also emphasizes that the real-time data collected must be used to improve real-time power system models with the status of all modeled elements and current values so the tools can convert data into accurate, dependable and timely information for operators. Furthermore, good data must be used to validate and maintain the accuracy of real-time and long-term planning models.

Synchrophasor technology can meet many of the RTBPTF’s demands for better real-time tools that enhance system operators’ situational awareness. A synchrophasor system with wide deployment of phasor measurement units and dedicated high-speed communications to collect and deliver synchronized high-speed grid condition data, along with analytics and other advanced on-line dynamic security assessment and control applications, will improve real-time situational awareness and decision support tools to enhance system reliability. Synchrophasor measurements can also be used to improve component and system models for both on-line and off-line network analysis to assess system security and adequacy to withstand expected

¹ Real-Time Tools Best Practices Task Force, “NERC Real-Time Tools Survey Analysis and Recommendations, Final Report,” March 13, 2008, Executive Summary p. 1.

² RTBPTF Executive Summary, p. 3.

³ RTBPTF Introduction, p. 10.

contingencies. But to realize this great potential, each interconnection must deploy a highly reliable, secure and robust synchrophasor data measurement and collection system and develop a suite of validated, highly available, robust and trustworthy analytical applications. Last, organizational support processes and appropriate training for use of the advanced technologies will need to be developed and implemented.

Table 1-1 below indicates that synchrophasor data can be used to support most of the RTBPTF's suite of reliability tools and practices.

Table 1-1 — RTBPTF Recommended Real-Time Tools Improved by Synchrophasors

RTBPTF Tools and Practices for Reliability⁴	Phasor technology improves this (Yes or No)
Situational Awareness Tools	
Alarm tools	Y through RT data and baselining
Visualization tools	Y through RT data
Network topology processor	Y through RT data
Topology & analog error detection	Y through RT data
State estimator	Y through RT data and redundancy (phasor data substituting for SCADA data)
Contingency analysis	Y through baselining and model improvements
Critical facility loading assessment	Y through real-time data
Power flow	Y through real-time data
Study real-time maintenance	No
Voltage stability assessment	Y through real-time data, baselining and advanced on-line analytical application
Dynamic stability assessment	Y through real-time data, baselining and advanced on-line analytical application
Capacity assessment application	Y through dynamic line rating tools
Emergency tools	Y through decision support analytics, islanding detection & aid in re-synchronization, frequency monitoring for black-start, SPS design through model improvements
Situational Awareness Practices	
Reserve monitoring	Y through real-time data
Alarm response	Y through operator support analytics and automated controls
Conservative operations	Y with sufficient baselining and validated system models
Operating guides (mitigation plans)	Y through improved modeling, baselining, and SPS design
Load-shed capability awareness	Y through real-time data on loads and modeling of load and frequency interactions
System reassessment and reposturing	Y through real-time data, on-line analysis

⁴ RTBPTF Introduction, pp. 12-13.

	and visualization tools
Black-start capability awareness	N

1.1 Synchrophasors

To understand how synchrophasors can enhance grid operations and planning, it is useful to understand phasor technology. Synchrophasors are precise time-synchronized measurements of certain parameters on the electricity grid, now available from grid monitoring devices called phasor measurement units (PMUs). A phasor is a complex number that represents both the magnitude and phase angle of voltage and current sinusoidal waveforms (60 Hz) at a specific point in time (shown in Figure 1-1).

Figure 1-1 — Sinusoidal Waveform and Phasor Representation

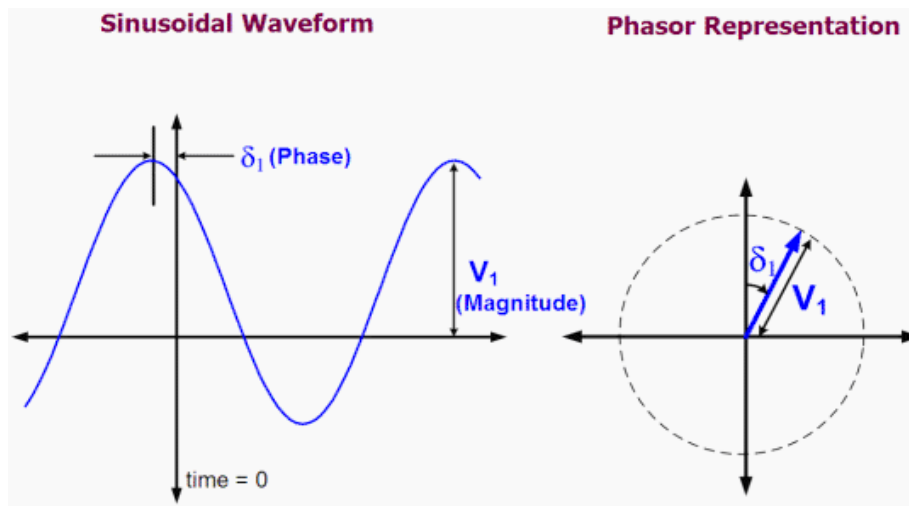

Source: CERTS, Phasor Technology Overview

PMUs measure voltage, current and frequency and calculate phasors, and this suite of time-synchronized grid condition data is called phasor data. Each phasor measurement is time-stamped against Global Positioning System universal time; when a phasor measurement is time-stamped, it is called a synchrophasor. This allows measurements taken by PMUs in different locations or by different owners to be synchronized and time-aligned, then combined to provide a precise, comprehensive view of an entire region or interconnection. PMUs sample at speeds of 30 observations per second, compared to conventional monitoring technologies (such as SCADA) that measure once every two to four seconds.

Besides “sub-SCADA” visibility, synchrophasors will enable interconnection-wide views of grid stress and dynamics, to better maintain and protect grid reliability. As CERTS explains, “... in an AC power system, power flows from a higher voltage phase angle to a lower voltage phase angle – the larger the phase angle difference between the source and sink, the greater the power flow between those points.” Greater phase angle differences imply larger static stress across that interface; larger stress could move the grid closer to instability.

Phasor data is being used in many ways. In California, phasor data drive the automated control of Southern California Edison’s Static Var Compensator (SVC) device for reactive power

support.⁵ The California ISO, Bonneville Power Administration, American Electric Power (AEP) and Tennessee Valley Authority are working to incorporate real-time phasor data into their state estimation tools to get more accurate and higher sampling rates than their SCADA systems can provide. After Hurricane Gustav struck the Gulf Coast in 2008, Entergy used its PMUs and analytical tools to manage system separation and islanding and later system restoration. The California ISO and ERCOT will be using phasor data to better monitor real-time intermittent generation and integrate those resources economically while protecting bulk power system reliability. Data from PMUs can let operators identify low frequency system oscillations and help engineers design ways to dampen and stabilize those oscillations.

This report reviews synchrophasor technology and how that technology can be used to protect and enhance grid reliability. The report particularly focuses on how close various phasor technology elements and applications are to the “production-grade” maturity needed to support day-to-day and emergency grid operations. For a variety of synchrophasor hardware (including communications systems) and applications, the report reviews current status, requirements for “production-grade” quality, and offers some speculation for the factors and timing for technology maturity.

1.2 Report Outline

This report discusses synchrophasor technology within two major categories — data measurement and collection system and applications. As shown in Figure 1-2, the synchrophasor data system includes measurement and communications of the measurements to control centers. Software applications use full-resolution real-time data, down-sampled real-time data, or historical data, along with grid models to support both operating and planning functions. These applications range from visualization of information and situational awareness to ones that provide sophisticated analytical or control functionality.

Figure 1-2 — Synchrophasor Data System and Applications

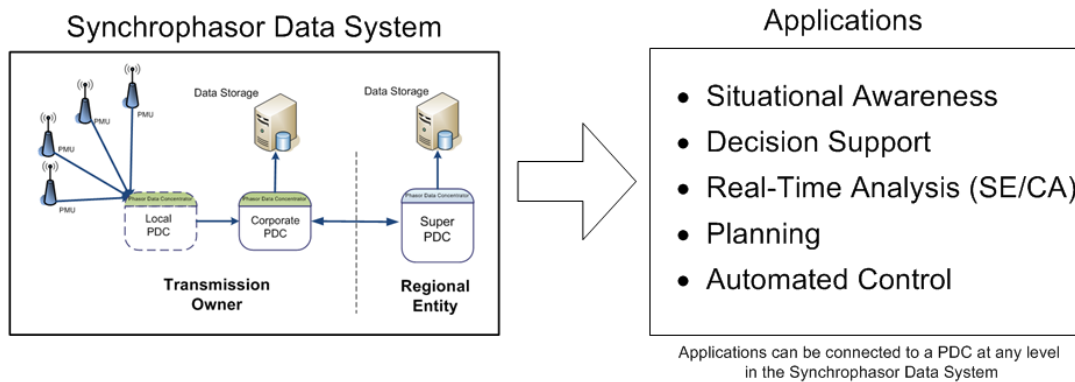

- Chapter 2 explores the question, what level of technology readiness will be needed to support bulk power system operations, and general requirements for “production quality” hardware and software applications in the electric bulk power system.
- Chapter 3 outlines the key elements of synchrophasor technology, including hardware and software, technical standards and security considerations.

⁵ “Dynamic Voltage Support with the Rector SVC in California’s San Joaquin Valley,” [Transmission and Distribution Conference and Exposition, 2008. IEEE/PES.](#)

- Chapter 4 reviews the various ways that synchrophasor data and applications can be used to support grid reliability, with a principal focus on operations and some attention to off-line planning uses.
- Chapter 5 offers conclusions, recommendations and a path forward for synchrophasor technology and bulk power system operations. This section addresses technology and interoperability standards, NERC reliability standards, and NERC's role in phasor technology development and deployment.

1.3 Background

The RAPIR Task Force prepared this report for the Operating Committee of the North American Electric Reliability Corporation, which asked how synchrophasors can be used to support and improve real-time operation of the bulk power system. The information in the report has been provided by members of the Task Force and by other members of the electric industry, including many members of the North American SynchroPhasor Initiative (NASPI), a joint industry-NERC-Department of Energy effort to accelerate the usefulness and readiness of synchrophasor technology.

The charter for this report asked the RAPIR task force to prepare a document that, “from a bulk power system reliability perspective, reviews existing PMU industry applications and identifies other high-value uses for system operations with focus on the 0 to 24 hour operating horizon.” The report should review phasor technology, survey current and evolving operational applications, and survey current North American and international phasor deployments. It should also evaluate any applicable NERC reliability standards and identify any gaps, explain NERC's current coordination efforts and offer recommendations for how to further advance phasor technology.

Readers should be aware that synchrophasor technology and its deployment are changing rapidly across North America and around the world. Thus, the descriptions and conclusions in this report should be viewed as specific to conditions in early 2010; hardware, software and technical standards and deployment are advancing quickly and could be very different in 2011 and beyond.

1.4 The Value and Promise of Synchrophasor Technology

Phasor data and applications are valuable for grid reliability because they give grid operators and planners unprecedented insight into what is happening on the grid at high resolution, over a wide area in time synchronized mode, and where needed, in real-time. Current SCADA systems observe grid conditions every 4 to 6 second, which is too slow to track dynamic events on the grid. They also do not monitor key indicators such as phase angles, SCADA data are not consistently time-synchronized and time-aligned and those data are not shared widely across the grid. Thus SCADA does not give grid operators real-time, wide area visibility into what is happening across a region or interconnection.

In contrast, synchrophasor systems allow the collection and sharing of high-speed, real-time, time-synchronized grid condition data across an entire system or interconnection. This data can be used to create wide-area visibility across the bulk power system in ways that let grid operators understand real-time conditions, see early evidence of emerging grid problems, and better diagnose, implement and evaluate remedial actions to protect system reliability. Phasor systems

are being used for wide-area measurement systems (WAMS) in the Eastern and Western Interconnections of North America and in China, Quebec, Brazil, and Europe.

The lack of wide-area visibility prevented early identification of the August 14, 2003 Northeast blackout. The U.S.-Canada investigation report into the blackout hypothesized that if a phasor system had been in operation at that time, the blackout preconditions — in particular, the growing voltage problems in Ohio — could have been identified and understood earlier in the day. In the last few minutes before the cascade, there was a significant divergence in phase angle between Cleveland and Michigan, shown in Figure 1-3 below.

Figure 1-3 — Diverging phase angles on the afternoon of August 14, 2003

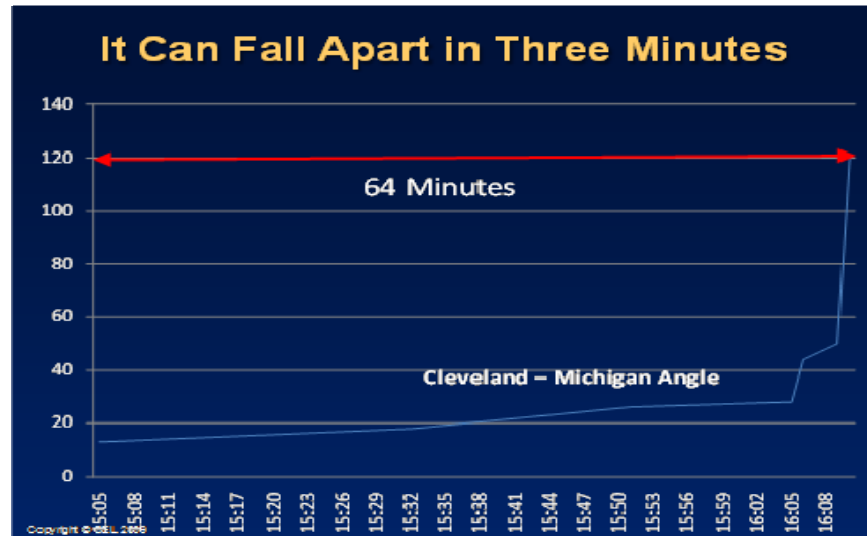

Image courtesy Schweitzer Engineering Laboratory

Having wide-area situational awareness could have prevented the Western Interconnection outages in the summer of 1996. BPA had several stand-alone PMUs in the field during the August 10, 1996 outage. Post-disturbance analysis indicated that the relative phase angles across Pacific Northwest were outside safe operating limits and that reactive reserves at power plants were low. BPA's recognition of the great value provided by the wide-area measurements led them in 1997 to develop the first Phasor Data Concentrator to network PMUs and stream data to control centers in real-time, implement a phase angle alarm using PMU data, and develop operating procedures on what to do when the angles change too quickly.

Effective visualization is a critical partner to effective analysis for wide-area situational awareness. Figure 1-4 shows two images from RTDMS, a grid visualization and analysis tool that uses synchrophasor data to show operators what is happening on the grid in real-time using various metrics and indicators.

Figure 1-4a — Phase angle differences across WECC control areas

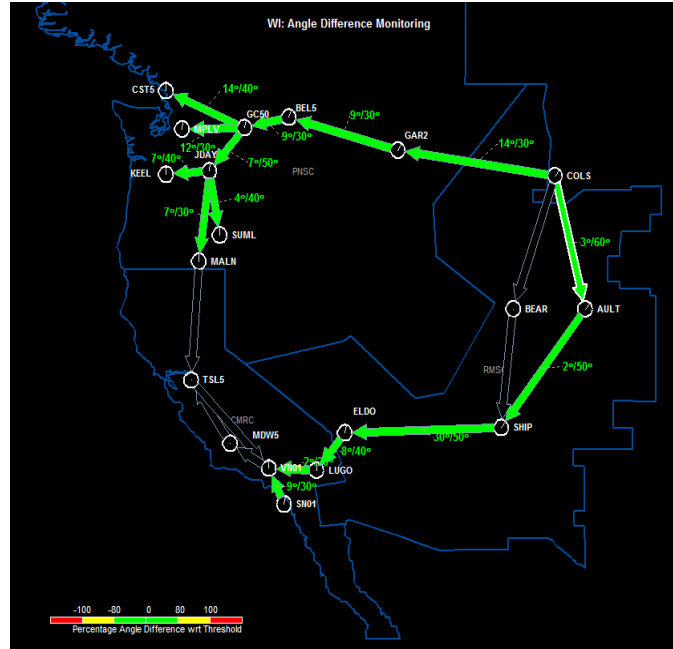
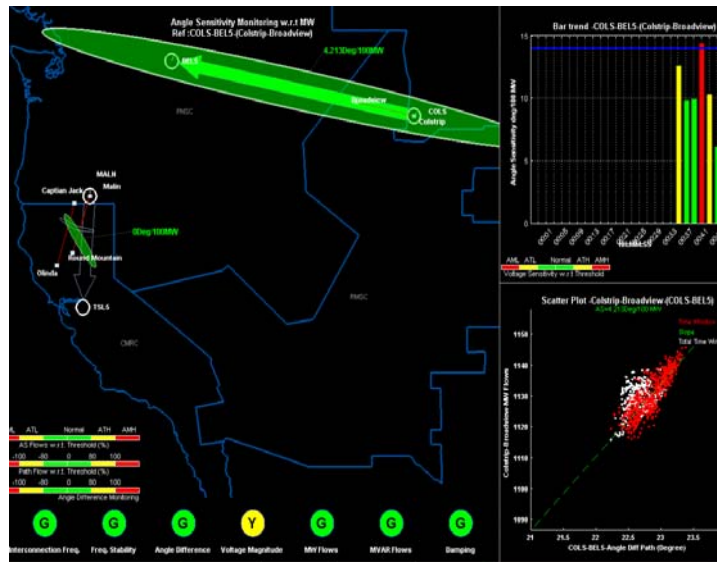

Figure 1-4b — Phase angle sensitivities across key WECC transmission paths



Because PMUs collect data at a much higher sampling rate than SCADA, the granularity of the data can reveal new information about dynamic stability events on the grid. This is evident in Figure 1-5, which compares the phasor data (right) to SCADA data (left) collected for the same event on February 7, 2010. This offers an example of the information that SCADA misses because its relatively slow scan times cannot capture the dynamic response of the system. The first plot shows 4 second scan rate SCADA frequency data for several sites in a small geographic

area. Some small fluctuations in system frequency are visible but since only two units recorded a change, the signals appear to be more noise than a measurement of anything of note.

Figure 1-5a — PMU Data v. 4-second SCADA data for February 7, 2010 event



Figure 1-5b shows PMU data from several sites for the same event. Not only did the PMUs reveal system dynamics that the SCADA data missed, it captured more accurate information about the event — note that the observed frequency excursion captured by the PMUs shown below was much larger than what the SCADA data indicated (59.91 HZ minimum versus 60.00 HZ). The PMUs also captured system oscillations that continued for about 7 seconds after the event.

Figure 1-5b — PMU data for February 7, 2010 event

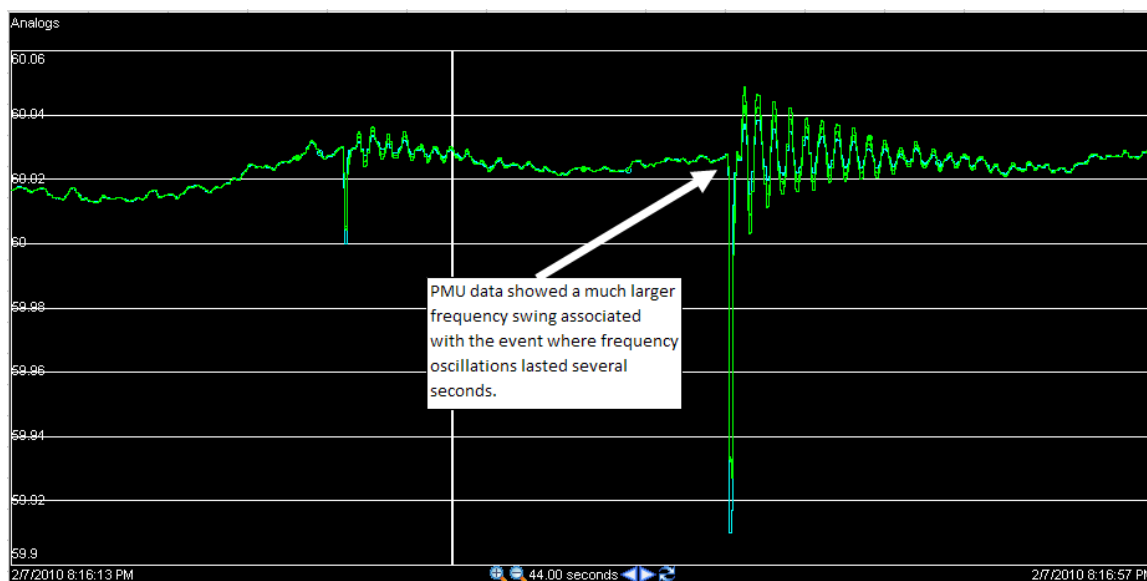

Similarly, phasor data can be used to inform and improve the internal calculations within bulk power system models and calibrate those models more effectively. Western Interconnection

modelers found that their models were not able to simulate actual system events using SCADA-measured data as the sole input source; as Figure 1-6 shows, actual oscillatory behavior that occurred on the WECC system as measured by PMUs (top graph) could not be simulated using WECC's models (bottom graph) until those models were calibrated using phasor data.

Figure 1-6 — PMU data identifies dynamics not captured in simulation models

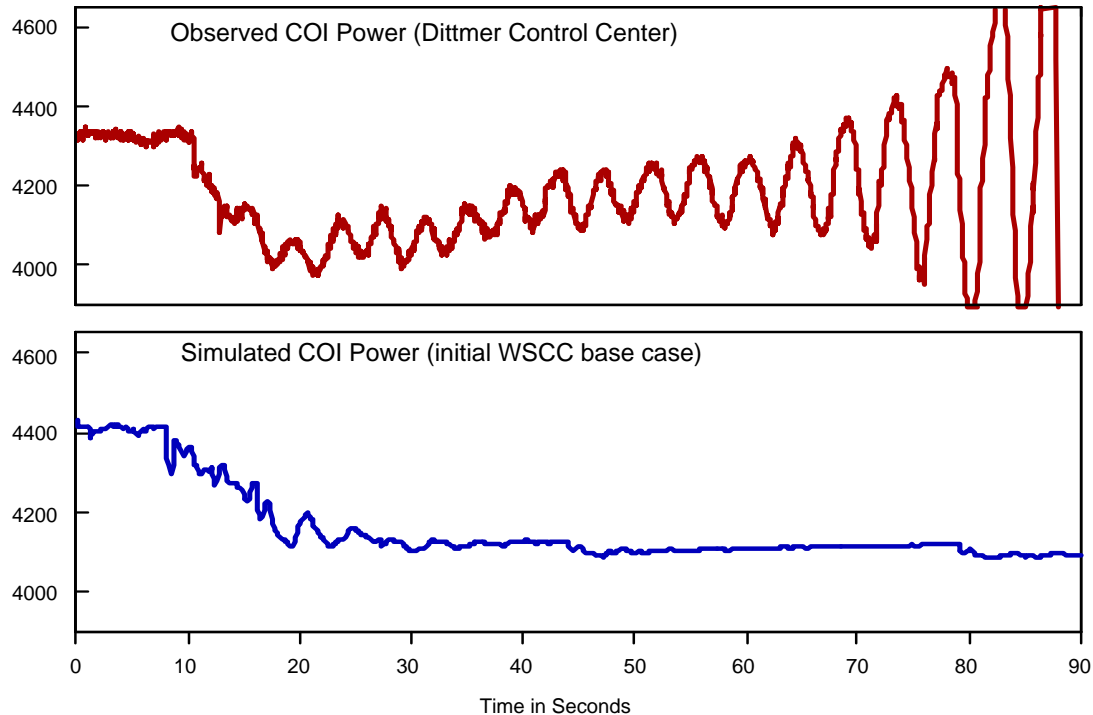

Phasor data are also valuable for investigation of grid disturbances, improving both the speed and quality of analysis. In the case of the 2007 Florida blackout, NERC investigators used phasor data to create the sequence of events and determine the cause of the blackout in only two days; in contrast, lacking high-speed, time-synchronized disturbance data it took many engineer-years of labor to compile a correct sequence of events for the 2003 blackout in the Northeast U.S. and Ontario. In another case, the detail contained within the available phasor data enabled operators to identify and mitigate a reliability problem. When a standing angle on an opened line prevented reclosing, such that redispatch and load-shedding were required, operators used their PMUs to monitor pre- and post-contingency angles to determine the severity and urgency of action by comparing the actual angles to operating nomograms.

Figure 1-7 shows a useful taxonomy of phasor data applications. These applications, and others, will be discussed in more detail in Chapter 4.

Figure 1-7 — Phasor applications taxonomy

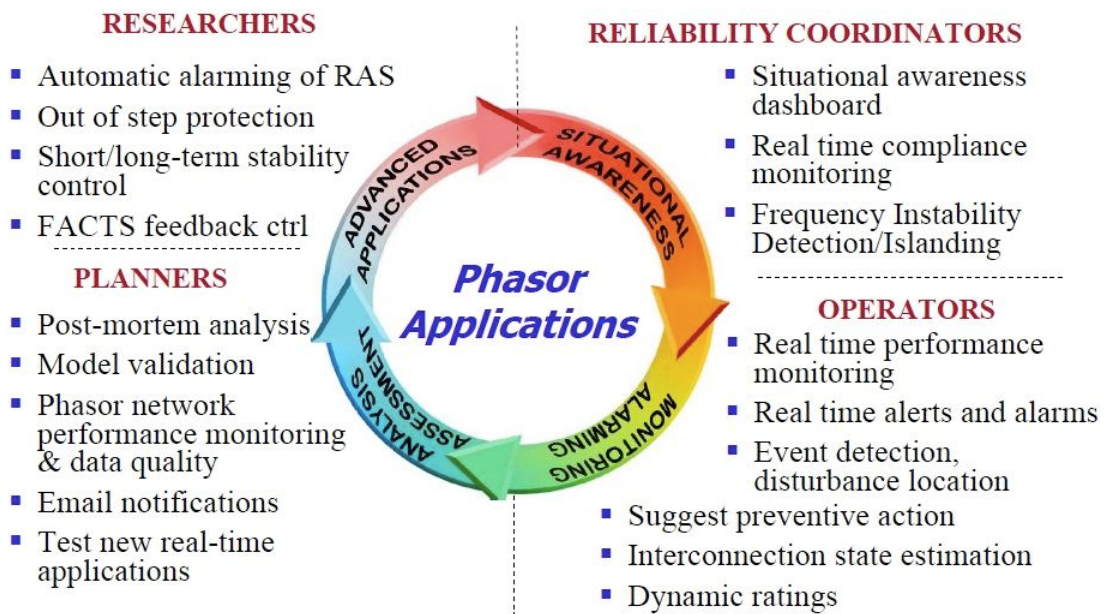

1.5 Synchrophasor System Deployment

In early 2010, there were about 250 PMUs deployed across North America (see Figure 1-8 below). Not all of those PMUs were sharing their data into an interconnection-wide system for wide-area monitoring, visualization and control. The number of PMUs will grow markedly in 2010-2012, as will the scope and breadth of phasor data applications, due to extensive new investments funded by federal Smart Grid Investment Grants⁶ and consortia of North American transmission asset owners.

⁶ Smart Grid Investment Grants are funded by the Department of Energy, issued under the American Recovery and Reinvestment Act of 2009.

Figure 1-8 — NASPI PMU locations, September 2009

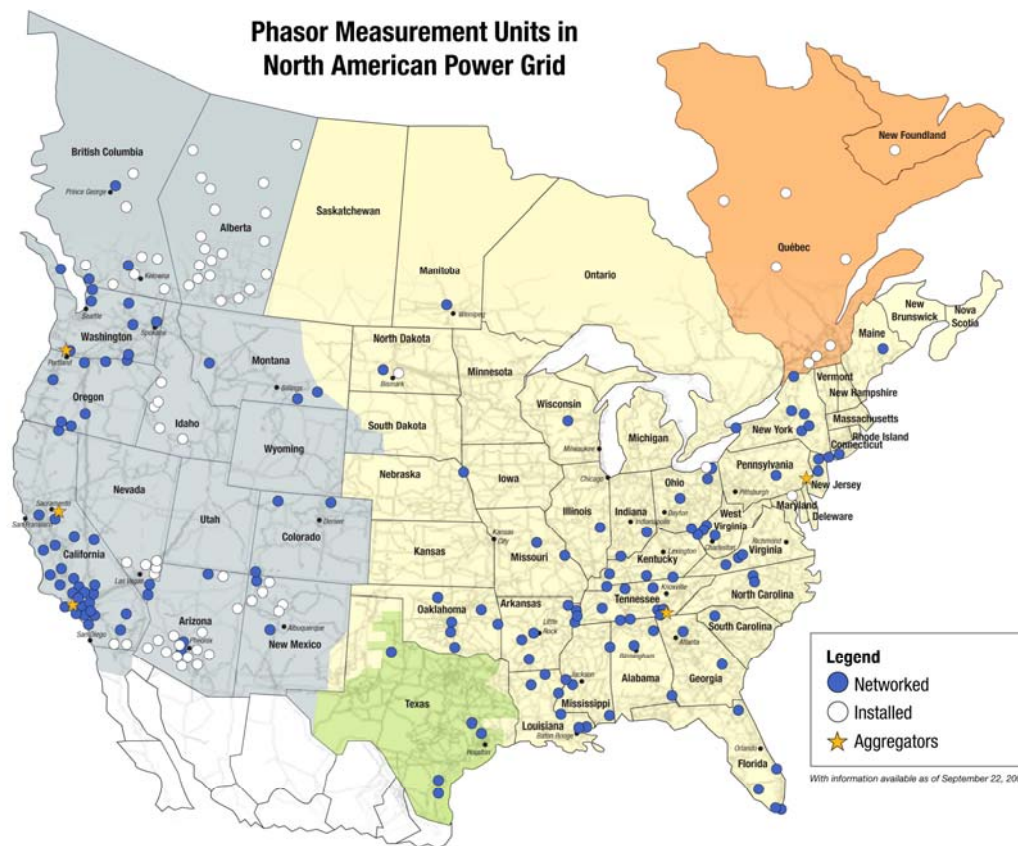

Table 1-2 lists the SGIG projects that will be installing over 850 new PMUs, synchrophasor communications networks, and developing and testing advanced phasor data applications in 2010 through 2013.

Table 1-2 — Smart Grid Investment Grants

Project Lead	Project investment Federal/Total (\$1,000s)	Key TO Partners	New PMUs Deployed	Key Applications
American Transmission Co.	PMUs U.S.: \$1,331 Total: \$2,662 Communications U.S.: \$11,444 Total: \$22,888	ATC	6	Real-time situational awareness Congestion management State estimator enhancement Unit dynamic model validation Post-event analysis Fiber optics network for phasor data
Center for Commercialization of Electric Technology (SG demo grant)	U.S. \$13,517 Total: \$27,419	ERCOT Oncor AEP Sharyland	13	Wind integration Evaluate current system models Real-time situational awareness Post-event analysis
Duke Energy Carolinas	U.S.: \$3,928 Total: \$7,856	Duke Energy Carolinas	102	Wide-area real-time situational awareness Enhanced state estimator

				Security monitoring Power system performance Renewables integration
Entergy Services	U.S.: \$4,611 Total: \$9,222	Entergy Services	18	Increase grid monitoring, train and educate grid operators and engineers on phasor technology
ISO New England	U.S.: \$3,722 Total: \$8,519	Bangor Hydro Central Maine Power National Grid Northeast Utilities NSTAR United Illuminating VELCO	30	Real-time situational awareness Congestion management
Midwest Energy	U.S.: \$712 Total: \$1,425	Midwest Energy	7	Real-time situational awareness Post-event analysis Protection system analysis
Midwest ISO	U.S.: \$17,272 Total: \$34,543	Duke Energy Great River Energy Hoosier Energy Indianapolis P&L ITC Holdings Minnesota Power Northern States Power Otter Tail Power Vectren Corp.	>150	Real-time situational awareness Voltage monitoring Renewables integration Congestion management State estimation Oscillation monitoring EMS alarms
New York ISO	U.S.: \$37,383 Total: \$75,712	Central Hudson G&E Consolidated Edison Long Island Power Authority National Grid New York Power Authority NYSEG Orange & Rockland Rochester G&E	39	Real-time situational awareness State estimation Voltage stability monitoring and control Voltage control Controlled system separation Improved frequency regulation
PJM Interconnection	U.S.: \$13,698 Total: \$27,840	Allegheny Power AEP Baltimore G&E Commonwealth Edison Dominion Virginia Power Duquesne Light FirstEnergy PECO Pepco Holdings PPL Electric PSE&G Rockland Electric	> 80	Real-time situational awareness, including trending Oscillation detection Islanding detection Event and alarm processing Congestion management
Western Electric Coordinating Council	U.S.: \$53,890 Total: \$107,780	BPA CAISO CEC Idaho Power NV Energy PacifiCorp PG&E Southern California Edison Salt River Project	> 250	Wide-area real-time situational awareness and visualization Alarming Oscillation monitoring Voltage monitoring Renewables integration Congestion management Automatic controls Power system performance analysis System-wide model validation Post-event analysis

1.6 Conclusions

Synchrophasor technology has the potential to greatly improve operators' ability to conduct real-time grid operations and detect and respond to potential disturbances. Phasor systems and data will help operators and planners improve:

- Wide-area visibility and situational awareness
- Static and dynamic models at the system level and for individual grid assets (e.g., power plants)
- Design of SPS/RAS schemes and other system controls using local and wide-area control signals
- Dynamic security assessment
- Decision support systems to reposition the grid to improve operational security and resiliency.

Although numerous companies are using phasor technology today to perform many of these functions, few of these efforts are yet fully deployed, tested, and performing at production-grade — as will be discussed in the rest of this report. But with Smart Grid Investment Grants and demonstration project investments accelerating the pace of phasor technology deployment and applications development, this situation is changing rapidly. Although phasor data uses are mature for many off-line planning purposes, the real-time operations examples below refer primarily to pilot implementations in place today. Three years from now, it is reasonable to expect that many of these operational uses have been greatly improved, tested, and won acceptance in control rooms and operators' desks across North America, and this report would offer many more specifics on how these technologies have been successfully used to improve operations.

Chapter 2 — What Is Technology Readiness for Power System Operations?

The Operating Committee has asked which phasor technology and applications are ready for use in real-time operations, which applications and technology should be top priorities for grid use, and when various applications will be ready for operations support. To answer these questions effectively, we must first understand what it means for a technology or application to be considered “ready” or “production-grade.”

2.0 Operations Use Requirements Vary

Bulk power system operations (those occurring within 24 hours of real-time) use synchrophasor systems in several different ways that have differing levels of reliability and readiness requirements. These are:

- Automated control of system equipment or operations
- Decision support, as to provide intelligent, analytically-based diagnoses, analyses and options that help operators respond to grid events
- Situational awareness tools, to help operators understand what is happening across a region (or at specific grid assets) in real-time
- Tools or information that are incorporated into operational standards and requirements
- Pilot or research-grade tools
- Planning and off-line tools, such as those used for system and power plant modeling.

A tool that will be used for decision support or automated control must meet much higher standards than one that is informational and considered to be research-grade rather than production-grade. But a number of factors affect whether a hardware or software system is technologically ready, reliable and trusted for operational use. These are:

- Operational availability and reliability
- Data quality
- Relevance and value for its targeted use
- Alarming for availability (failure)
- Physical and/or cyber-security
- Testing
- Training for operators and support staff
- Technical support (internal and vendor).

These factors can be expressed as metrics and used to express goals or targets for the quality and reliability of a synchrophasor system or other operating reliability tool. In the case of synchrophasor technology, the different system elements — hardware, software applications, communications and business support — are each at very different levels of readiness relative to these metrics. For instance, PMUs are a long-established and well-supported technology (that is now being stretched to meet new performance requirements), but most phasor data applications are relatively young and are still research-grade with a need for more experience, testing and availability.

2.1 What Is Production-Grade?

Many operators and utility executives say that a phasor system or application must be “production-grade” before it can be installed and integrated into bulk power system operations — but few are able to define production-grade. At least some of the characteristics of such a definition must be articulated for device and applications researchers and vendors to understand and meet operators’ demands. The list below offers some of the possible metrics and measures for what might constitute production-grade for phasor system elements to be used for real-time bulk power system operations. This list is intended to prompt discussion rather than be viewed as a firm list of requirements.

2.2 Dimensions and Potential Requirements for a Production-Grade System

Production-grade means an application ready for use by end users, fully supported and maintained in operational condition 24x7. There are no changes made without proper planning and testing, and service level agreements are in place to address response protocols for failures or degraded modes. The hardware and software are robust and rugged, designed and used for intensive business and enterprise computing or operational environments.

The list below should be modified as the SGIG synchrophasor projects clarify their hardware, software and communications requirements.

Hardware

- Designed to meet operational requirements for a specific application
- Product or software is vendor-supported 24x7
- Minimum availability of 99.95%
- Meets or complies with relevant technical standards (1588, 37.118, 61850)
- Digital frequency transducer accurate to ≤ 0.001 Hz and MW, MVAR and voltage transducer metering accurate to $\leq 0.25\%$ of full scale per NERC BAL-005
- Failover capability
- Vendor problem reporting and resolution process
- Prompt field maintenance for any device problems (by vendor or owner)

Applications – should eventually parallel those requirements applicable for state estimators or contingency analysis tools

- Availability %
- Solves 95% of time or runs
- Provisions to prevent data loss during system failure
- Rigorous change protocols and vendor patch and update management process
- Process for code sharing and review
- Rigorous testing
- Detailed error handling with input and data validation
- Documentation for application – code, operational and maintenance instructions
- Methods of displaying information and analytical results have been tested and accepted as helpful by users
- User training and documentation
- Prompt maintenance and correction for any operational failures (by vendor or owner)

Data quality — should eventually parallel those requirements applicable to SCADA systems

- Frequency – the RTBPTF recommends that standards be updated to require telemetry data have a minimum update frequency of at least once every 10 seconds;⁷ existing synchrophasor systems can deliver data at a rate of at least 30 samples per second.
- Data availability at 99 percent for good data received to total data received, for 99% of the sampled periods during a calendar month, and not less than 99% for any 30 consecutive minutes.⁸
- Concentrator – Corrections to a reference bus for phase sequence and transformation phase shift
- Data delivery speed – latency requirement
- Data quality and reject rate
- Data accuracy (As specified in IEEE 37.118 as well as Dynamic Performance requirements being considered for the standard.)

Communications system — should eventually parallel those applicable to SCADA systems

- Availability %
- Reliability
- Data losses
- Redundant delivery method
- Security to appropriate level
- Cumulative latency of data delivered from field through PDCs to applications acceptable given nature of application used
- Vendor support for any availability or reliability problems

System

- Timeliness or delay of processed or derived information delivered to users
- All functionality tested in simulated and operational scenarios
- Actual system has been fully demonstrated, tested and validated in its operational environment with a proven correlation to other systems
- Alarms for failures of the phasor system communications, PMUs, applications or hardware elements
- Successful operational experience (system operators' sign-off)

⁷ RTBPTF Introduction, p. 21.

⁸ RTBPTF Introduction, p. 21.

System architecture

- High availability architecture
- Failover capability
- Security integrated into design and implementation

Business processes

- Successful operational experience
- Proficient, prompt, end-to-end sustaining engineering support in place
- Integrated with operational hardware and software systems
- Standard training for users
- Appropriate levels of physical security and cyber-security (meets or exceeds NERC CIP)

Need not entail but good to have:

- Applicable technical standards (as from NERC, IEC, IEEE, etc.)
- Third-party performance testing and certification
- Commercially available from multiple competing vendors
- Number of vendors selling comparable product

Chapter 3 — Synchrophasor Data Systems

The purpose of a synchrophasor data system is to make rapid measurements (at least 30 per second) of voltage and current phasors (magnitude and their respective phasor angles) that include precise time stamps and to make these measurements available to analyze and display grid conditions in transmission and power system control centers. Ultimately, synchrophasor data systems may be used for automated control of the grid.

The components of a synchrophasor data system include:

- **Phasor Measurement Unit (PMU)** — Calculates voltage and current phasors based on digital sampling of alternating current (AC) waveforms and a precise time signal provided by a GPS clock. A PMU provides output data in a standard protocol at rates of at least 30 samples per second for communication to remote locations.
- **Communications** — A mechanism to transport the digital information from the PMU to the location where the data will be used. Communication is typically provided through a private wide-area network (WAN) but can be any digital transport system that offers acceptable security and availability; functional requirements for a synchrophasor system architecture called “NASPInet” have been developed to provide for flexible, fast, vendor-agnostic, and secure communication of phasor measurements from data collection points to various levels of PDCs and phasor application use points
- **Phasor Data Concentrator (PDC)** — Receives and time-synchronizes phasor data from multiple PMUs to produce a real-time, time-aligned output data stream. A PDC can exchange phasor data with PDCs at other locations. Through use of multiple PDCs, multiple layers of concentration can be implemented within an individual synchrophasor data system.
- **Data Storage** — Systems to store synchrophasor data and make it conveniently available for post-real-time analysis can be integrated with the PDC or be stand-alone data historians or, in the case of smaller implementations, be traditional relational data base systems.

Applications that use time-aligned phasor data from the PDC include oscillation detection systems, visualization tools and state estimators; many people do not consider the applications to be part of the phasor data system.

3.1 Phasor Measurement Units and GPS

A phasor measurement unit (PMU) is considered to be any device that uses digital signal processors that measure 50/60 Hz AC waveforms (voltages and currents). The analog AC waveforms are digitized by an analog to digital converter for each phase and a phase-lock oscillator and a Global Positioning System reference source provides high-speed time-synchronized sampling.⁹ A PMU calculates line frequencies, voltage and current phasors at a high sampling rate and streams those data, along with the associated GPS time stamp, over networked communication lines. Most commercially available PMUs today take 30 samples per

⁹ CERTS, “Phasor Advanced FAQ, What is a Phasor Monitoring Unit?”
Real-Time Application of Synchrophasors for Improving Reliability
10/18/2010

second, but several new applications and users are asking vendors to produce PMUs sampling at a 60 frames per second rate.

This functionality need not be the sole function or purpose of a device; for instance, many digital relays have PMU functionality but their primary purpose is to serve as a relay rather than as a PMU.¹⁰ Any device that incorporates this functionality — such as digital fault recorders (DFRs) and digital relays — is considered a PMU device. Other unrelated functions of the device must be shown not to affect the performance of the PMU component, and equally importantly the PMU functions must not affect the other functions of the device. The synchrophasor and frequency values must meet the general definition as well as the minimum accuracy requirements given in the IEEE C37.118 standard.

PMUs are typically installed in a substation or at a power plant. Each phasor requires three separate electrical connections (one for each phase), to either measure a current (from a line or bank) or a voltage (from either line or bus PTs). A typical PMU installation is shown in Figure 3-1.

Figure 3-1 — PMU Installation

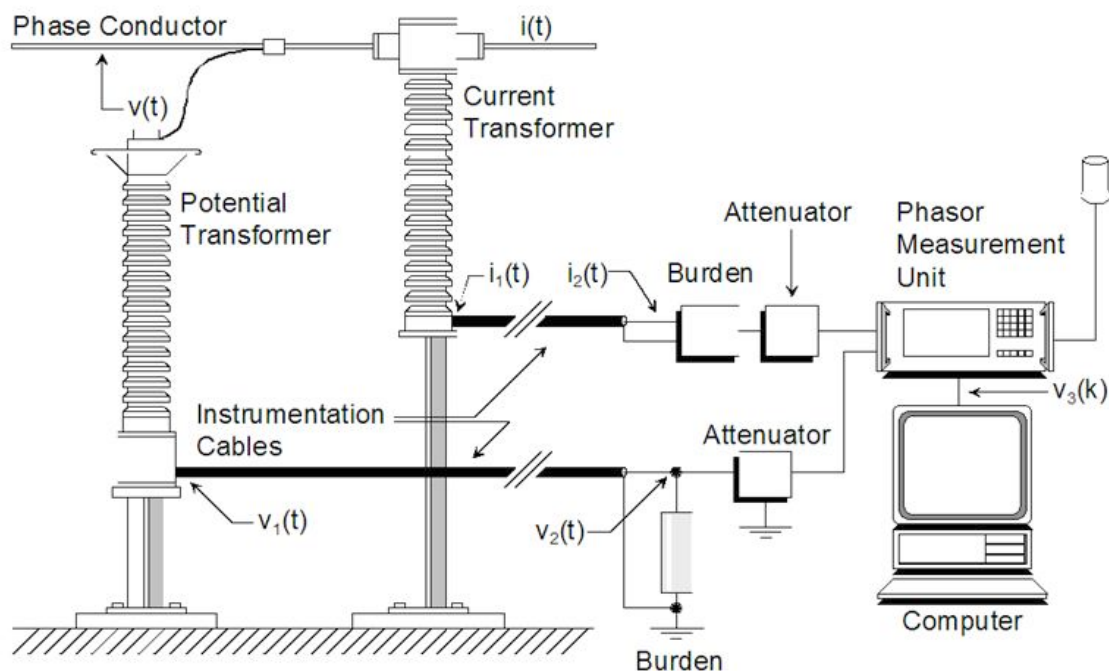

Source: CERTS, “Phasor Advance FAQ”

Recent specifications for a PMU can be found at http://www.naspi.org/resources/pstt/martin_1_define_standard_pmu_20080522.pdf. Several manufacturers have been building commercially available devices to these specifications for several years. However, several of the new SGIG projects are setting higher technical performance requirements and specifications as they invest their funds in new PMUs, a new

¹⁰ Thousands of digital relays installed on the grid now have IEEE C37.118 PMU capability (at varying sampling speeds), although that capability must be activated with a firmware upgrade. See http://www.naspi.org/pmu/compatible_pmu_capable_devices_20091113.pdf.
Real-Time Application of Synchrophasors for Improving Reliability
10/18/2010

communications system and more demanding phasor data applications, and manufacturers are working to build devices that will meet these new specifications.¹¹

A PMU also performs pre- and post-processing of the data collected, including proprietary phasor computation algorithms, anti-alias filtering, and other measures.

Many industries establish formal performance and interoperability testing and certification processes for common devices such as PMUs. The electric industry has not reached that point yet with PMUs, because the number purchased has been small, technical standards have been limited, and buyers' specifications have varied widely. Today there is a push to devise and implement formal PMU testing programs, although that will not be fully effective until the IEEE and IEC standards update is completed.

Technology Standards are Changing Rapidly

The standards and specifications for PMUs are evolving quickly. The electric industry has embarked on an effort to articulate, update and integrate a wide suite of technical standards required for grid modernization. Synchrophasor technology standards are a high priority in this effort, given the value of phasors for bulk power system reliability.

The key standards for synchrophasor technology include: IEEE 37.118 for Synchrophasors for Power Systems, IEC 61850 for substation automation and transmission device communications, and IEC 1588 for time synchronization. Many U.S. and international representatives from transmission asset owners, grid operators, PMU manufacturers and other stakeholders are working to update, integrate and harmonize these technical standards.¹² Updated IEEE and IEC synchronization standards reflecting the first round of harmonization should be adopted by the respective technical standards development organizations in 2011.

Industry members continue to work on technical issues that need to be clarified but are not yet tested and ready for adoption. These include guidelines for dynamic PMU sampling, PDC to PDC communications, and more. Phasor data are stored using COMTRADE standard C37.110 as the default file format; the COMTRADE standard is also being modified to reflect new communications uses.

Before a set of technical rules becomes a formal technical standard, it has been developed, tested and subject to extensive industry discussion; it is used as a guideline and gains common acceptance as it is incorporated into buyers' specifications and manufacturers' claims. Eventually such a guideline is tweaked, made more precise, and adopted through a formal standards development process by an organization such as IEEE-PES. Groups working within the NASPI framework have been developing guidelines and protocols related to synchrophasor

¹¹ See information on the specifications under consideration at <http://www.naspi.org/meetings/workgroup/workgroup.stm>, listed under "February 25, 2010 PMU Specifications Comparison and Review."

¹² See information on this process at <http://collaborate.nist.gov/twiki-sggrid/bin/view/SmartGrid/PAP1361850C27118HarmSynch> and in the presentation by Jerry FitzPatrick at the October 4, 2010 NASPI meeting at <http://www.naspi.org/meetings/workgroup/workgroup.stm>. Real-Time Application of Synchrophasors for Improving Reliability
10/18/2010

technology that may eventually become codified into formal technical standards or referenced in reliability standards.¹³ These guidelines will change over time as technology capabilities and users' needs evolve.

Today there are over 15,000 relays and Digital Fault Recorders deployed on the grid that can be upgraded to PMU functionality using firmware upgrades (IEEE 37.118-compatibility, at 30 samples/second or better). These upgraded devices can be used, like new PMUs, for high-speed grid monitoring, automated operations, forensics, and model calibration. A list of IEEE 37.118 compatible, PMU-capable, upgradable relays and DFRs (according to manufacturers' claims) can be found at http://www.naspi.org/pmu/compatible_pmu_capable_devices_20091113.pdf.

Over 80,000 devices already deployed on the grid, such as digital relays and digital fault recorders, could be turned into low-speed (one sample/second) PMUs. These devices can be used for low-speed wide-area visualization.

Each PMU has an associated GPS device, sometimes external to the PMU, which pulls in the universal time code to stamp each measurement taken by the PMU.

NASPI PMU Registry

In the near future, every PMU that is connected into a wide-area monitoring system should be registered in the NASPI PMU Registry. NERC is developing the NASPI PMU Registry to provide a repository for phasor measurement locations and PMU configuration settings. The Registry will assign a unique identifier to each source and type of phasor measurement, so that every PDC and phasor data application will be able to associate measurements with a particular identifier to a specific PMU model, owner, electrical system location, and type and source of measurement (e.g., current, phase A, transformer low side). As such, the Registry will not contain phasor data, but only metadata about the PMUs, in a highly secure and confidential environment. The Registry can also store additional measurement keys that are used by individual utilities or regions to facilitate integration of the Registry with legacy systems.

NERC has hired the non-profit Grid Protection Alliance to build and operate the PMU Registry for industry use. The PMU Registry has been in beta-test mode since December 2009 and is expected to be ready for PMU owners to use to formally register their PMUs in the fourth quarter of 2010.

¹³ These include:

- PMU installation and communications interconnection
- the NASPInet architecture design
- PMU-to-PDC communications protocols
- PDC-to-PDC communications protocols
- PMU Registry device identification and measurement identification conventions
- PMU performance evaluation and testing
- PDC performance specifications.

3.2 PMU Measurements and Sampling Rates

The number of measurements made by individual PMUs can vary over a broad range — from a handful to many dozen — depending on PMU capabilities and the number of transmission elements to be monitored. These measurements typically include frequency, real, reactive power, raw voltage and current phasors for each transmission element. PMUs can also output individual phase RMS values, which is useful for detecting unbalanced conditions that may exist in the system. The current rule of thumb is that each PMU makes about 20 measurements — sixteen of these are 8 phasor measurements with a magnitude and angle for each.

The IEEE C37.118 standard allows for a variety of sampling rates ranging from 10 to 120 per second, with some PMUs capable of even higher sampling rates. While most PMUs now sample at 30 measurements per second, several of the Smart Grid Investment Grant (SGIG) phasor projects are contemplating applications that will require PMU sampling speeds of 60 per second, and some envision a future standard sampling rate at 120 per second (the Nyquist rate for AC power systems in North America).

What PMUs measure and compute

Most PMUs compute and report the absolute angle of each of six phasors and some devices report the positive, negative, and zero sequences of both voltage and angle. These absolute angles become meaningful as phasor measurements are compared to each other, using the convention of a “reference bus” that serves as the common comparison point. The IEEE C37.118 frame utilizes the UNIX time tag convention (defined as the number of integer seconds since January 1, 1970). The IEEE C37.118 protocol also addresses time precision; most PMUs measure fractions of 10 microseconds.

Phasors from most PMUs can be represented in either rectangular or polar form with the angle measured in radians. The values for either can be floating point or integers that must be scaled to engineering units with conversion factors. Each PMU-owning company can select the format that works best for them. Many PDCs are designed to accommodate these conversions so that the resulting PDC output represents all phasors from all PMUs from all companies in the same way.

PMUs produce large amounts of data that need not overload a modern communications system. As seen in Table 3-1, the communications bandwidth consumed with phasor data would be about 57 kbps using UDP for 2 PMUs at a substation; for comparison, this is about 1/25 of a T-1 rated line (1.54 Mbps). A PMU-owning company needing to forward full-resolution data from 40 PMUs at 60 samples per second would require something in the order of 1.5 T-1s (including necessary headroom). Within one day, 100 PMUs sampling at 30 samples per second will generate 180 megabytes of data.

Table 3.1— Approximate bandwidth (kbits/sec) as a function of PMUs and sampling rate

Samples per Second	Number of PMU's			
	2	10	40	100
30	57	220	836	2,085
60	114	440	1,672	4,170
120	229	881	3,345	8,340

Values in kilobits per second (kbits/s)
Assumes 20 measurements per PMU (16 are used for 8 phasors)

Consider a network in which one PMU sends 12,000 samples per second to the host computer. Each sample consists of a time stamp (minimum of four bytes) and the data value (typically eight bytes), and four more bytes for data storage overhead. Thus 40 PMUs feed data into the network at 192,000 bytes per second. This translates to about 15.5 gigabytes per day of disk space or about 5.6 terabytes (TB) per year. Assuming a super-PDC at an ISO may concentrate 10 companies' PDCs, this number multiplies to 56 TB a year per ISO. A network of nine super-PDCs would generate a cumulative total of 509 TB a year, or half a petabyte of data.

3.3 Phasor Data Concentrators

A phasor data concentrator collects phasor data from multiple PMUs or other PDCs, aligns the data by time-tag to create a time-synchronized dataset, and passes this dataset on to other information systems. A PDC also performs data quality checks and flags missing or problematic data (waiting for a set period of time, if needed, for all the data to come in before sending the aggregated dataset on). Some PDCs also store phasor data and can down-sample it so that phasor data can be fed directly to applications that use data at slower sample rates, such as a SCADA system.

While there are no formal standards yet for the functional requirements of a PDC, it is generally accepted that the minimum requirements of a PDC include the ability to:

- Correlate phasor data by time tag and then broadcast the combined data to other systems
- Conform to streaming protocol standards (e.g., IEEE C37.118) for both the phasor data inputs and the combined data output stream
- Verify the integrity and completeness of data streams from PMUs and properly handle data anomalies
- Buffer input data streams to accommodate the differing times of data delivery from individual PMUs.

The NASPI Performance Standards Task Team is now developing PDC performance requirement guidelines that will parallel or clarify the requirements embedded in several SGIG procurement specifications. It is expected that these technical requirements will evolve from commonly accepted guidelines into technical protocols or standards adopted by IEEE.

There are three levels of PDCs, as shown in Figure 3-2.

Figure 3-2 — Levels of PDCs

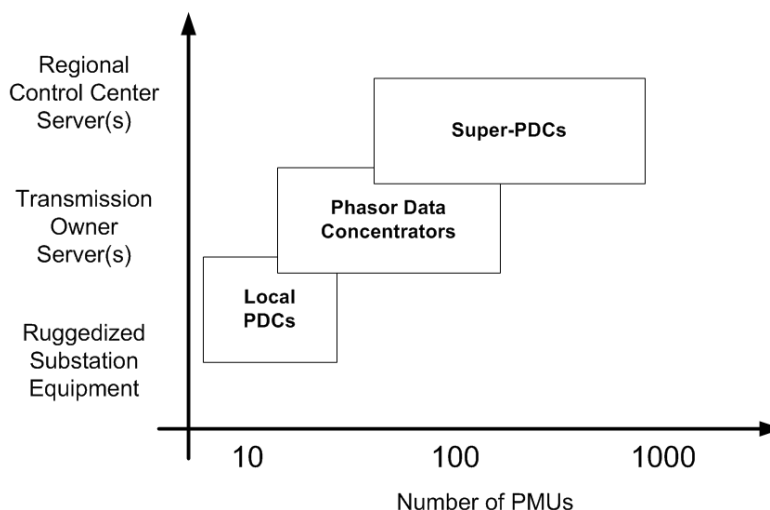

The functions of a PDC can vary depending on its role or its location between the source PMUs and the higher-level applications. A local PDC may be located physically close to PMUs (typically at a substation) to manage the collection and communication of time-synchronized data from local PMUs, send it to higher level concentrators, and store the data for use within the substation. A local PDC may store a small cache of local measurements to prevent against network failure, and should be the source of data for local automated control functions. A local PDC is generally a hardware-based device that should require limited maintenance and can operate independently if it loses communications with the rest of the synchrophasor network.

A PDC that operates within a control room aggregates data from multiple PMUs and PDCs. It must conduct real-time data quality checks and calculations at very high speed — with real-time sample rates currently at 30 samples per second and heading higher, a real-time calculation must be completed very quickly, before the next set of values arrive. PDCs typically utilize threading and other parallel computing techniques available within modern operating systems to manage multiple connections at high speeds. PDCs must be adaptable to new protocols and output formats as well as interfaces with data-using applications. PDCs should incorporate inter-utility standards to allow for efficient machine-to-machine, program-to-program-compatibility. It is expected that the grid operators that host PDCs will demand these capabilities from PDC vendors, and that these capabilities will be written into specifications and tested for effective interoperability performance before acceptance.

A super-concentrator (super-PDC) operates on a regional scale, handling phasor measurements from several hundred PMUs and multiple PDCs. It collects and correlates phasor data from remote PDCs and PMUs and makes them available as a coherent, time-synchronized dataset to applications such as wide-area monitoring and visualization software, energy management systems and SCADA applications. A super-PDC also feeds the data into a central database for long-term data archiving (data historian function). Super-PDCs are software implementations, running on mainstream server hardware, as these larger devices need to scale rapidly to serve growing utility and regional deployment of PMUs and diverse phasor data applications.

PDCs are commercially available from several vendors. Based on their performance history, these PDCs are generally considered to be production-grade systems. Even so, PDCs have not yet been performance-benchmarked. While it is likely that the SGIG projects will accelerate the development of PDC performance and test standards, there are currently no formal standards for evaluating and rating PDCs.

NERC is currently funding development of a scalable network of super-PDCs through a contract with the Grid Protection Alliance, which is building upon the super-PDC now in use at TVA for Eastern Interconnection phasor data concentration. (See the openPDC project at <http://openpdc.codeplex.com> for more information.)

3.4 Data Storage

Data historians, optimized to effectively handle large volumes of time-stamped measurement data, are typically used to save and retrieve phasor data. Traditional relational databases can be used to manage phasor data for a short period of history or for implementations that contain a small number of PMUs. Distributed non-relational databases are used to manage big datasets by large internet firms like Google and Yahoo. These systems have some relational database features that can be used effectively with data systems that contain many, many terabytes of information. They divide the data up into smaller blocks that are processed in parallel. This technology is being explored for use in synchrophasor data systems as well.

The volume of streaming phasor data can make storage requirements add up quickly. For ease of retrieval and use, data is stored as time-value pairs either in a data historian or in a relational database. Not counting data structure overheads (that include the point ID), the minimum possible size storage is 10 bytes per time-value pair (4 bytes for time, 4 for data and 2 for flags) within a historian. Thus a PDC that collects data from 100 PMUs of 20 measurements each at 30 samples per second, will require a little over 50 GB/day¹⁴ or 1.5 TB/month of storage within a historian system. Long-term storage requirements for a relational database would be significantly higher.

Case studies using different storage systems provide additional insight on the large storage requirements for phasor data. The Tennessee Valley Authority operates a Super-PDC that collected phasor data from an average of 90 PMUs across the Eastern Interconnection in 2009. It archives the data in a historian with no data compression, requiring approximately 30 GB per day or 11 terabytes for the year. By comparison, a year of measurements from 105,000 points of TVA's SCADA system required only 90 GB of storage — less than 1% of the volume of the current phasor system.¹⁵

¹⁴ This value can be compared to the communications bandwidth values in Table 3.1 to understand the efficiency of the IEEE C37.118 protocol, which produces a frame of data under a single time stamp. IEEE C37.118 enables data that requires 50 GB/day in storage to be communicated to the PDC using about half the amount of data.

¹⁵ Storage requirements could be reduced by compressing the data without loss of significant information; for SCADA data, compression techniques have been shown to reduce data storage requirements by up to 90 percent. The best methods to compress phasor data are currently being researched since even the least significant bits of information in phasor information can contain information on power system oscillations.

The phasor community is beginning to develop standard formats for phasor data, or changing existing formats to accommodate phasor information. For example, the widely-used COMTRADE format is being tuned so that phasor data can be effectively stored in this format and used with tools that are COMTRADE compatible.

Currently there are no formal data retention standards for phasor data. Current phasor system managers are keeping full resolution phasor data archived for at least one year to facilitate disturbance investigation and research, with data pertaining to disturbances retained longer. Data retention issues can be evaluated once the industry has a few years of experience with the larger synchrophasor systems being developed with SGIG funding.

3.5 The Need for Redundancy

As synchrophasor data becomes more important to the planning and operation of the electric grid, there is a need to architect and design systems that have a commensurate level of availability. One great value of having a synchrophasor system with a dedicated, independent data network is that it creates a redundant source of operational data to support grid management in the event that the operator loses SCADA data or the SCADA communications network. To date there has not been much consideration of how to use a phasor network to backhaul operational commands, but that possibility is likely as asset owners look for ways to maximize the asset value in the pursuit of reliability.

Continuous availability is assured by increasing redundancy throughout the synchrophasor data system. PDCs should be implemented as a redundant pair in control center environments to assure that there are no systemic data gaps as standard maintenance is performed on PDCs. As phasor data becomes more critical, these redundant PDCs will be required in both primary and backup control centers.

Figure 3-3 shows a fully redundant architecture, from redundant PMUs, to redundant communications (over paths as diverse as possible), to redundant PDCs at both primary and backup control centers for PMU owners as well as regional entities.

Figure 3-3 — Redundant PDC and Communications Design

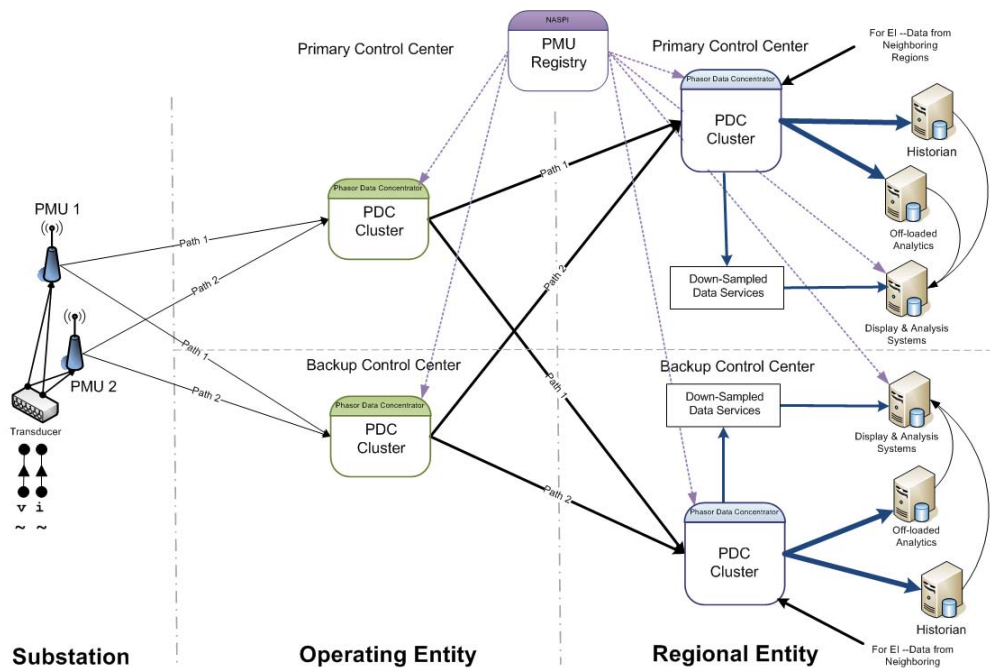

This traditional architecture presents challenges with management of phasor data — particularly at the regional level as data volume is multiplied through redundancy — and it creates a greater need for structured management of PMU configuration data like that provided by the NASPI PMU Registry. Even so, PDC and communications redundancy will be necessary to maintain wide-area visibility and phasor data applications integrity against the sudden loss of an individual control center or communications link.

3.6 NASPInet and Synchrophasor Network Architecture

DOE, in partnership with the electric industry, is working to develop a standardized communications network design to support synchrophasor data collection and sharing. Using DOE funding, a NASPI team has developed data architecture, composed of phasor gateways and a data bus that will integrate into the users' enterprise IT infrastructures. Once fully deployed, NASPInet will be a design layer on top of a physical communications transport network that could support hundreds of phasor gateways and thousands of PMUs. Initial specifications and designs for the NASPInet architecture, along with industry comments on those specifications, are at <http://www.naspi.org/resources/dnmt/dnmtresources.stm#q6>.

NASPInet will provide the protocols and services for effectively exchanging phasor data. The physical communications network underlying NASPInet is presently expected to operate much like NERCnet (used today to exchange data among SCADA systems using the ICCP protocol). This model assumes that some entity will acquire private communications bandwidth from traditional telecom providers and will charge for its use based on a billing metric. However, neither NERC nor DOE have made any commitments to support the build-out and long-term maintenance of NASPInet and phasor communications networks; current communications networks for phasor data are being supported by individual asset owners or consortia developed under SGIG projects.

The challenge of managing a high availability system is simplified considerably by using a data bus to transfer data between PDCs. Data bus technology has been successfully deployed in other industries for both critical control and business applications. The data bus manages the flow of data, the data schema and all essential aspects of a distributed application. It offers detailed quality of service (QoS), control of reliability, performance monitoring, cyber-security and access policy enforcement over different classes of data exchanged, and provides redundancy. The data bus also implements reliable multicast for wide-area multi-point integration, while working over WAN networks and intelligently traversing firewalls. Data is placed on the bus and removed from the bus through agents or adapters; these agents can run on the same hardware as the system injecting or removing the information, or on hardware tailored to the data bus.

NASPInet was designed to improve the interoperability and performance of synchrophasor systems. Phasor gateways will be the sole access points for utilities into the data bus, managing connected devices, quality of service, cyber-security and access rights, effect data conversions, and interface a utility's own network with the data bus. NASPInet will operate with a publish/subscribe data exchange mechanism. Figure 3-4 shows NASPInet's conceptual architecture.

Figure 3-4 — NASPInet Conceptual Architecture

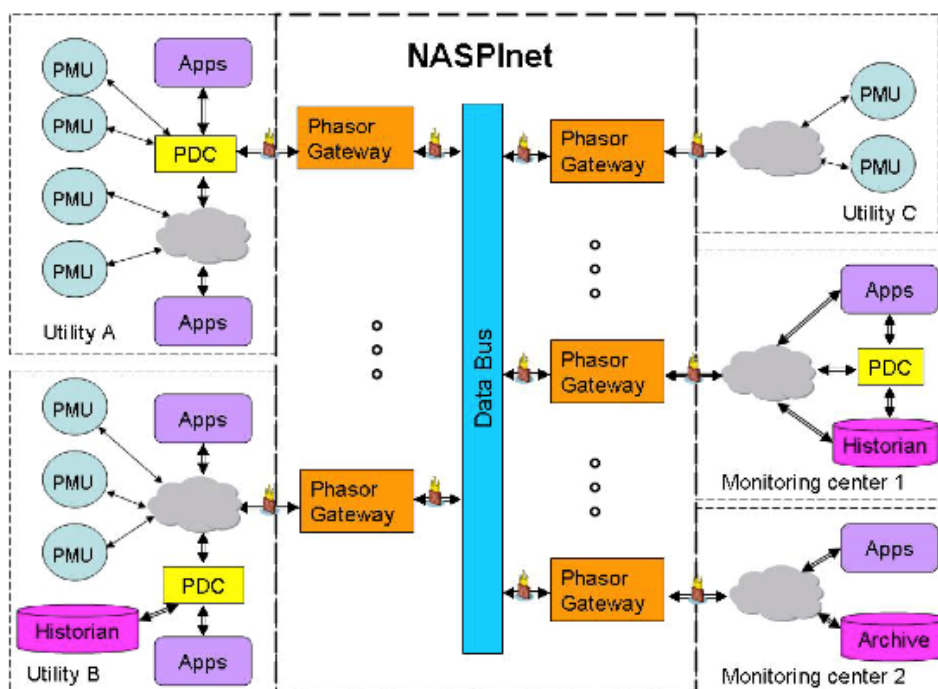

The NASPInet architecture is not yet tested and its specifications allow for diverse interpretation. Most of the new Smart Grid Investment Grant (SGIG) projects will be implementing elements of the NASPInet architecture for their phasor data communications networks. The variation across these implementations will provide insight into the effectiveness and feasibility of the NASPInet framework and test its interoperability. By 2014, the lessons learned from the SGIG projects should allow the industry to determine whether and how the NASPInet architecture needs to be changed or implemented to optimize robust, timely, secure dataflow across each interconnection, and finalize the NASPInet architecture and implementation into a coherent, workable whole.

The NASPInet implementations now underway in the SGIG projects are all considered to be more than pilots but may not reach production-grade for several years yet.

3.7 Security

Most current phasor systems feed wide-area monitoring and visualization systems to improve situational awareness; few utilities or grid operators are using phasor data to drive automated control operations or other critical operations. Although NERC's critical infrastructure protection standards (CIP-002 through CIP-009) are not necessarily applicable to phasor systems today, many current synchrophasor projects are applying state-of-the-art physical and cyber-security requirements to phasor systems — in part because most existing PMUs are installed within high-security substations and share mission-critical transmission system communications networks. This will change with several of the new SGIG phasor projects, which are building dedicated communications networks for phasor data transport.

Transmission owner and grid operator phasor system installations should assess phasor-related personnel, systems and networking components, data exchanges, system configurations, communications, applications, and business processes. The assessments should consider security standards including:

- IEC 62351 describes recommended security profiles for various communications media and protocols
- NERC CIP 002-009 establishes cyber-security standards
- IEEE 1686-2007 describes security measures from the perspective of an IED (intelligent electronic device)
- IEEE C37.118 is the communications protocol for PMU communications
- NIST Special Publication (SP) 800-53 are guidelines for federal information systems
- FIPS 199 and FIPS 200 are the foundation of system classifications.

Although initial phasor system implementations for phasor systems that are non-critical cyber assets need not comply with all physical and cyber-security requirements, many of the organizations installing phasor networks are focusing on the protection of PMUs, data in transit, the monitoring of network conditions, user access controls, and designing their systems either to fully comply with security requirements today, or to be easily modified to comply with future security requirements. As the NERC CIP standards evolve, they may well encompass phasor data systems in the future.

In September, 2010, the Smart Grid Interoperability Panel's Cybersecurity Working Group completed the Guidelines for Smart Grid Cyber Security, an exhaustive discussion that includes cybersecurity recommendations for the bulk power system.¹⁶

3.8 Technical Standards and Interoperability for Phasor Systems

Several technical standards pertain to synchrophasor technology:

- IEEE C37.118

¹⁶ <http://collaborate.nist.gov/twiki-sggrid/pub/SmartGrid/CSCTGStandards/StandardsReviewPhase-1Report.pdf>.

- IEC 61850
- IEC 1588.

These technical standards have been recognized as a priority for harmonization and modernization and are being revised by international teams of experts from across industry and academia. In October 2011, NIST submitted five “foundational” smart grid standards to the Federal Energy Regulatory Commission for consideration and adoption;¹⁷ IEC 61850, updating and expanding communications networks, system and data formats for substation automation, was included as one of these standards.¹⁸ These updated standards are expected to be incorporated into buyers’ specifications and vendors’ products within five years.

The existence of technical standards is necessary but not sufficient to improve the reliability and interoperability of phasor technology. Members of NASPI’s Performance and Standards Task Team and the National Institute of Standards and Technology-facilitated Wide-Area Monitoring and Visualization and Time Synchronization Team have identified additional needs for technical specifications and testing that could lead to future technical standards development, revisions or protocols:

- PDC functions and performance requirements
- PMU-to-PDC and PDC-to-PDC communications protocols, including handling of missing data and automatic device configurations
- PDC calibration and test guidelines
- Specifications of PMUs for dynamic measurements
- Protocols for PMU and PDC interoperability and conformance testing against the standards.

More information about technical standards development is available from the NASPI Performance & Standards Task Team¹⁹ and the NIST PAP-13 twiki site.²⁰

¹⁷ See “NIST Identifies Five “Foundational” Smart Grid Standards,” October 13, 2010, at http://www.nist.gov/public_affairs/releases/smartgrid_100710.cfm.

¹⁸ See “Summary of Use, Application, Cybersecurity, and Functionality of Smart Grid Interoperability Standards Identified by NIST, Release 1.0, October 6, 2010,” for IEC 61850 at <http://collaborate.nist.gov/twiki-sggrid/bin/view/SmartGrid/NISTStandardsSummaries>.

¹⁹ See <http://www.naspi.org/resources/pstt/psttresources.stm>.

²⁰ See <http://collaborate.nist.gov/twikisggrid/bin/view/SmartGrid/PAP1361850C27118HarmSynch>.

Chapter 4 — Phasor Data Applications and Grid Reliability

4.0 Applications Overview

Phasor data applications can be grouped into three categories:

- Applications to support real-time grid operations by providing wide-area visualization and increased state awareness,
- Applications to improve system planning and analysis, including power system performance baselining, event analysis and model validation, and
- Response-based control applications that use real-time wide area information to take automated control actions on the power system.

Real-time applications require real-time data collection and processing with immediate analysis and visualization or used as control signals for real-time controls applications. Planning and post-event analysis applications use archived data and may be conducted off-line days or months after the data were collected. This chapter reviews principal applications groups in each of these three categories, and then briefly discusses phasor data classes as they relate to applications, and operator training and the role of phasor technology to support operator decision-making.

The applicants for synchrophasor-related Smart Grid Investment Grant (SGIG) put extensive thought into the types of synchrophasor applications that they will deploy over the next several years. Those SGIG applications and project plans provide realistic assessments of what is feasible to implement in the next few years and how these application benefit system reliability. The presentations made by SGIG recipients at NASPI meeting reflect these evaluations and priorities:

- WECC
http://www.naspi.org/meetings/workgroup/2010_february/presentations/wednesday_am/vanzandt_wecc_sgigawardee_20100224.pdf
- PJM
http://www.naspi.org/meetings/workgroup/2010_february/presentations/wednesday_am/ulmer_pjm_sgigawardee_20100224.pdf
- MISO
http://www.naspi.org/meetings/workgroup/2010_february/presentations/wednesday_am/zwegel_miso_sgigawardee_20100224.pdf

This chapter reviews each set of applications and the data and communications requirements appropriate to each purpose.

4.1 Phasor Data Use for Real-Time Operations

This paper defines operations environment as that occurring in real-time, extending up to a day. All real-time operations uses of phasor data exploit the insight these data offer due to high sampling speed, new granularity into phase angles and other grid conditions, and time-synchronization. These measurement characteristics also enable exceptional visualization, analytics and alarming — all of which improve operators' ability to see and understand what is happening on the bulk power system, anticipate or identify potential problems, and identify, evaluate, implement and assess remedial measures. However, phasor applications must synthesize and summarize large amounts of phasor data for operators, preventing information overload and presenting actionable information in an easily understandable manner so that quick and reliable decisions can be made.

Most power system operators today have very little visibility into power system dynamics such as power oscillations, voltage stability indications, and system angular stress. Large-scale integration of renewable resources will present an additional challenge to the system operators, as large and fast power ramps by intermittent generators can dramatically shift generation patterns and operating conditions. Visibility of power system dynamics is becoming even more critical as the power system grows with inclusion of more variable resources with less offsetting machine inertia to stabilize the system.

4.1.1 Wide-area situational awareness

The idea of using wide-area synchronized measurements for wide-area visualization can be traced to early-mid 1990s — it was one of the key lessons learned from cascading outages that occurred in the Western Interconnection in 1996 and the Eastern Interconnection in 2003. Several utilities and grid operators have developed in-house tools for wide-area visualization using wide-area synchronized data.

Bonneville Power Administration (BPA) had several stand-alone PMUs in the field during its 1996 outage. Event analysis demonstrated that PMUs would have provided early warning to operators by revealing angular stress and providing visibility of the power oscillations. Following disturbance report recommendations, BPA developed the first Phasor Data Concentrator in 1997 and started streaming PMU data to its control centers in real-time and expanding PMU coverage. BPA developed the first visualization tool in 1997 to display live PMU data, called Stream Reader. BPA integrated phasor data into its EMS and developed a phase angle alarm in 1997 using relative phase angles from Grand Coulee, John Day and Malin.

Southern California Edison (SCE) also developed a prototype of a situational awareness room, displaying a combination of trending plots and phase-angle pie charts to display phasor data in real-time. The SCE system is called the Synchronized Measurement and Analysis in Real Time (SMART®) tool. SMART® can monitor system parameters in real-time from PMU data, including stress (angle separation), inter-area voltage support, and transient swings. It was developed as the real-time counterpart to the Power System Outlook (PSO) tool and has the valuable capability to play back past disturbance events for training purposes.²¹

²¹ See Bhargava, B., Salazar, A., "Synchronized measurement and analysis in real-time SMART® - system at Southern California Edison (SCE) Co," Transmission and Distribution Conference and Exposition: Latin America, 2008 IEEE/PES, pp.1-6, 13-15 Aug. 2008, and http://www.naspi.org/meetings/workgroup/2009_june/presentations/botello_sce_grid_control_center_200 Real-Time Application of Synchrophasors for Improving Reliability 10/18/2010

Figure 4-1 below shows a screen snapshot of SCE SMART® system during 3-unit Palo Verde outage that occurred on June 14 2004. The display includes a compass plot of angular separation, and time plots of bus voltages and frequencies across the Western Interconnection.

Figure 4-1 — SCE SMART® display of June 14 2004 major disturbance

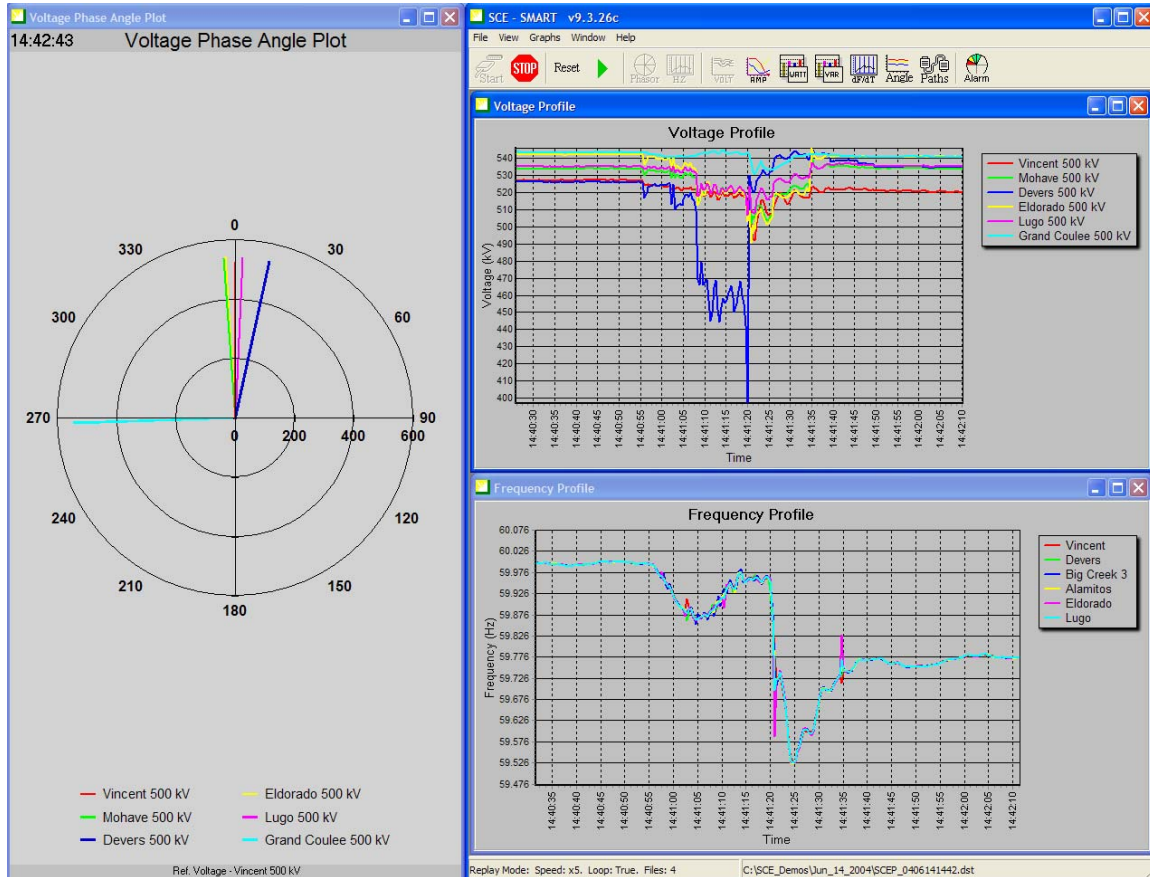

RTDMS software, developed initially with funding from the U.S. Department of Energy, is a phasor data-based software platform used by grid operators, reliability coordinators, and planning and operations engineers for real-time wide-area visualization, monitoring and analysis of the power system. RTDMS offers a real-time dashboard with indicators of key grid metrics for situational awareness. The software can be used to identify, monitor and alarm for:

- Grid stress – phase angular separation
- Grid robustness – damping status and trend
- Dangerous oscillations – low damping and high mode energy
- Frequency instability – frequency variation across interconnection
- Voltage instability – low voltage zones and voltage sensitivities
- Reliability margin – “How far are we from the edge?”

RTDMS also archives event data for event and post-disturbance analysis.

[90604.pdf](#)

Figure 4-2b — RTDMS view of Eastern Interconnection at 13:09:08 EST, after start of Florida grid disturbance

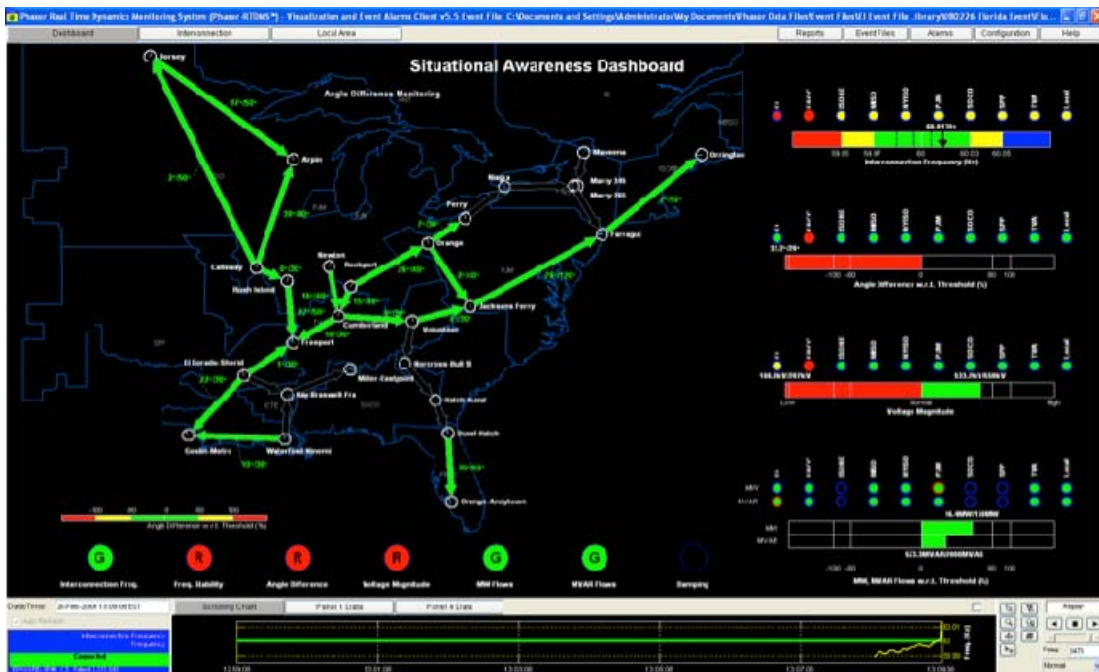

RTDMS is widely used in North American control rooms, but is not yet viewed as a commercially sustainable, production-grade reliability tool. At present RTDMS only operates on phasor data and does not include other SCADA information, and it has no linkage to other power system study tools.

AREVA T&D's *e-terravision*TM is designed to help operators monitor, predict, anticipate and prevent potential problems that can lead to major power outages. *E-terravision*TM significantly improves transmission system operations and control by helping to eliminate reactionary decisions being made in control centers today. *E-terravision*TM supplements control rooms with higher level decision support capability using visualization, “smart applications” and simulation for improving situation awareness. It is an operator-friendly system that enables power dispatchers to fully visualize their networks with the right level of situation awareness and to proactively operate the grid by taking the necessary real-time corrective actions.

AREVA claims the following characteristics for *e-terravision*TM:

- Task-oriented design for immediate access to critical data and minimized user actions to get the required information
- Complete view of the transmission system guarantees full awareness before making decisions
- Predictive analysis tools and simulation provide early warning alerts to plan an optimized set of actions
- Intuitive design for rapid learning curve and increased productivity
- Common standard of visualization for a cooperative environment among utilities and faster crisis solving.

E-terravision is commercially available, production-grade, and fully integrated into Areva's suite Real-Time Application of Synchrophasors for Improving Reliability
10/18/2010

of EMS software.

PowerWorld Retriever is a real-time visualization and analysis tool used in several control rooms around the country and a few overseas. It was developed based on PowerWorld Corporation's popular PowerWorld Simulator product. PowerWorld Simulator began development in 1994 and Retriever in 2000. PowerWorld Retriever has the ability to simultaneously visualize related quantities such as voltage magnitude, phase angle, and angle differences (along with line flow, breaker status, or any other power system measurement or combination of measurements). Retriever can connect to multiple data sources at the same time, including PI Server, eDNA Server, SQL server, and flat text files.

PowerWorld Retriever has an integrated topology processing tool that allows full topology (bus breaker) power system models to be created and solved with post-state estimator data. This allows the user to do away with translation of data between operating and planning models and solve breaker contingencies that are impossible to solve with planning models. An example visualization of PMU data is shown in Figure 4-3. Retriever has the capability to integrate Geographic Information Systems (GIS) support, which streamlines information mapping (as for weather conditions) to geographic maps. Retriever also offers alarm management, animation and contour mapping.

Figure 4-3 — PowerWorld Retriever for wide-area monitoring and visualization

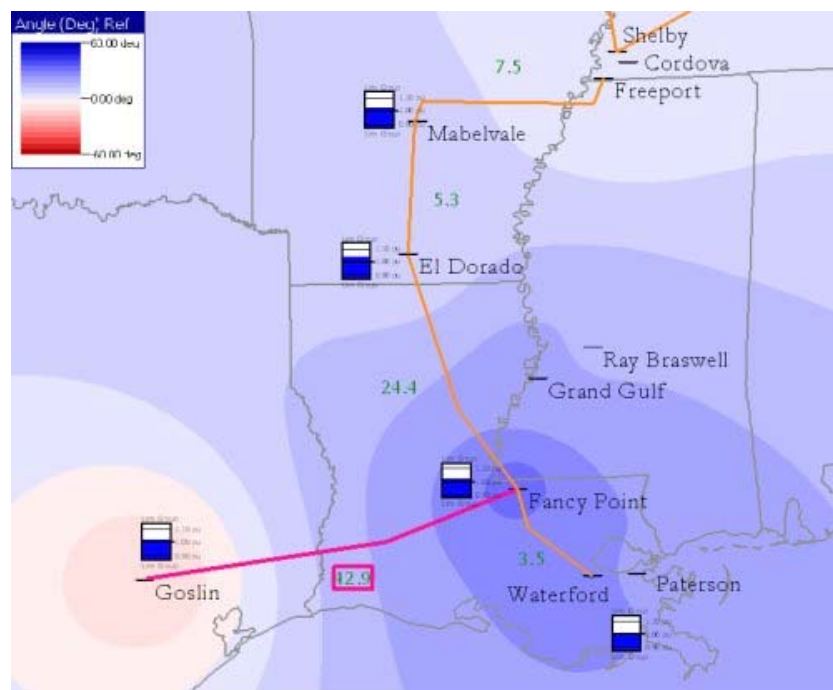

Gauges show voltage magnitude; contouring shows phase angle, with numeric readings for angle differences across path and dynamic emphasis showing alarm condition (in pink).

These are some of the entities and applications now in use for phasor-based wide-area monitoring and visualizations, with links to material on specific uses:

- CAISO – using RTDMS to for WECC wide-area visualization and monitoring
http://www.naspi.org/meetings/workgroup/2008_june/success/california_iso_synchrophasor_update_hawkins.pdf
- Entergy and AEP – dynamic security assessment
http://www.naspi.org/meetings/workgroup/2008_october/presentations/11_asu_application_vittal_20081016.pdf
- China – using phasor network for wide-area visualization and fault analysis
http://www.naspi.org/meetings/workgroup/2007_september/presentations/ecec_synchrophasor_act_hong09072007.pdf
- Power World for situational awareness
http://www.naspi.org/meetings/workgroup/2008_june/vendor/powerworld_realtime_visualization_dahman.pdf
- Real Time Dynamics Monitoring System™ (RTDMS) alarming tools
https://events.energetics.com/v&c08/pdfs/RC_RTdms.pdf
http://www.naspi.org/resources/oitt/naspi_oi_display_tool_conventions_standards_guidelines_010307.ppt
http://www.naspi.org/resources/training/2008_0122/rtdms_training_package.pdf
- Hydro Quebec wide area monitoring and control
<http://www.ieee.org/organizations/pes/meetings/gm2006/html/slides/PESGM2006P-000401.pdf>
- Line outage detection using phasor angle measurements
http://www.pserc.wisc.edu/ecow/get/publicatio/2007public/tate_overbye_pes_nov2007.pdf
- SCE SMART® software for visualization
http://www.edison.com/files/0607_sce_phasrmt.pdf
- EPRI - Wide Area Power System Visualization and Near Real-Time Event Replay Using SynchroPhasor Measurement
http://www.naspi.org/meetings/workgroup/2009_october/presentations/zhang_epri_waps_v_20091008.pdf
- TVA - Wide Area Visualization Tools for Responding to Major Energy Disruptions
http://ewh.ieee.org/conf/tdc/King_Wide_Area.pdf
- Wide-Area Frequency Visualization Using Smart Client Technology
<http://ieeexplore.ieee.org/iel5/4275198/4275199/04275768.pdf?arnumber=4275768>
- RTDMS -- visualization, monitoring, alarming and reporting capabilities
http://www.naspi.org/meetings/workgroup/2007_september/presentations/oitt_report_bilke09072007.pdf
- http://www.naspi.org/meetings/workgroup/2009_june/presentations/botello_sce_grid_control_center_20090604.pdf
- E-terravision: <http://www.aveva-td.com/solutions/liblocal/docs/Automation-other/e-terravision-brochure-v1.0-FINAL.pdf>

4.1.2 Frequency stability monitoring and trending

System frequency is the key indicator of the load-resource balance. The size of the frequency deviation is well correlated with the size of generation loss — Figure 4-4 shows an example of frequency response to a generation outage. System frequency is also a good indicator of integrity of an interconnection during system events involving separation or islanding — if a bus frequency in one part of the system stays at 60.5 Hz while frequency in another part of the system holds at 59.5 Hz for several minutes, it is a sure indication of the system separation. Looking at the bus frequencies across the entire interconnection lets the operator identify the islands and system separation points.

PMU frequency plots provide a good indication of the lost generation — as an example, a frequency drop of 0.1 Hz is typical in the WECC for 800 MW generation loss. Also, the propagation of the frequency drop can be used to identify where the generation drop occurred.

Figure 4-4 — Western system frequency during a large generation outage on July 17, 2002

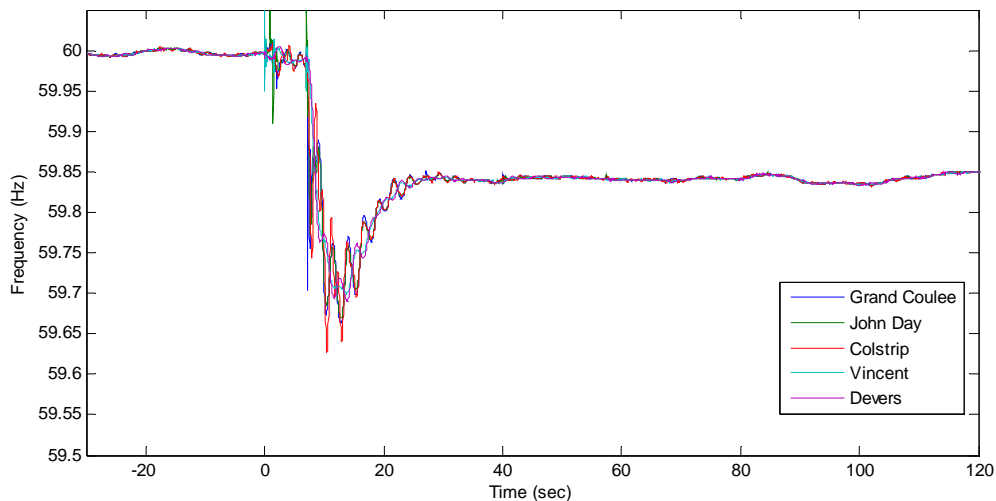

Wide-area frequency trending is one of the most straightforward applications, and has been implemented by many platforms, including BPA Stream Reader, SCE SMART®, and RTDMS. TVA and EPRI have been developing a tool called the Synchronous Frequency Measurement System (SFMS) to use synchrophasor data for wide-area visualization and disturbance location.²²

4.1.3 Power oscillations

Detection of power system oscillations and ambient grid damping are among the premier applications that require the high-speed data that PMUs provide and conventional SCADA does not. Low-frequency oscillations occur when an individual or group of generators swing against other generators operating synchronously on the same system, caused by power transfers and high-speed, automatic turbine controls attempting to maintain an exact frequency. Low-frequency oscillations are common on most power systems due to either power swings or faults; undamped oscillations can swing out of control and cause a blackout (such as the Western

²² See Zhang G., “Wide-Area Frequency Visualization Using Smart Client Technology,” No. 1016207, Technical Update, Dec. 2007.

Interconnection event on August 10, 1996). Small-signal oscillations appear to have been increasing in the Eastern and Western interconnections, causing an urgent need to better understand the problem, detect when oscillations are occurring, and find ways to improve oscillation damping and implement system protections against collapse.

Synchrophasor data (bus frequency, angles, line loading and voltage) are critical to detect potential and actual oscillations within the bulk power system. Inter-area oscillations can be seen by examining bus voltages and frequencies, so most methods of oscillation detection are applied to the path or flowgate. Oscillation detection methods calculate the damping of a ring-down during a system disturbance. The energy of power oscillations indicates whether an oscillation is growing or dissipating. A build-up in energy signals growing oscillatory activity, and can alert an operator to check other indicators.

There are two distinct tools for identifying power oscillations:

- Oscillation detection — tools that calculate damping after a disturbance occurred. This is done in several seconds when oscillations are large in magnitude.
- Mode meters — tools that estimate damping from ambient noise data. These methods extract intelligence from small-signal oscillations from minutes of ambient noise. Mode meters are particularly useful for operations since they can provide early detection of damping issues in the system.

Montana Tech, University of Wyoming, and Pacific Northwest National Laboratory have worked closely with BPA and DOE to develop “Mode Meter” algorithms based on wide-area PMU measurements. Mode meter is a powerful method for monitoring the small signal stability properties of a power system in real-time, giving operators essential information regarding the health of the power system and allowing them to take preventive actions when needed. The developed algorithms have been evaluated with simulation data and validated with field measurement data. It has been demonstrated that the mode meter can identify the oscillation modes that caused the Western Interconnection breakup in 1996 (see Figure 4-5 below) and could have issued an early warning on the lightly damped mode. Current efforts have been focused on model and data validation and performance evaluation to reduce false alarms and missing alarms. It is worth noting that the best performing signals for oscillation damping estimation are relative frequencies on both sides of an oscillatory mode, which requires synchronized wide-area measurements.

Figure 4-5 — Example Mode Meter Screen

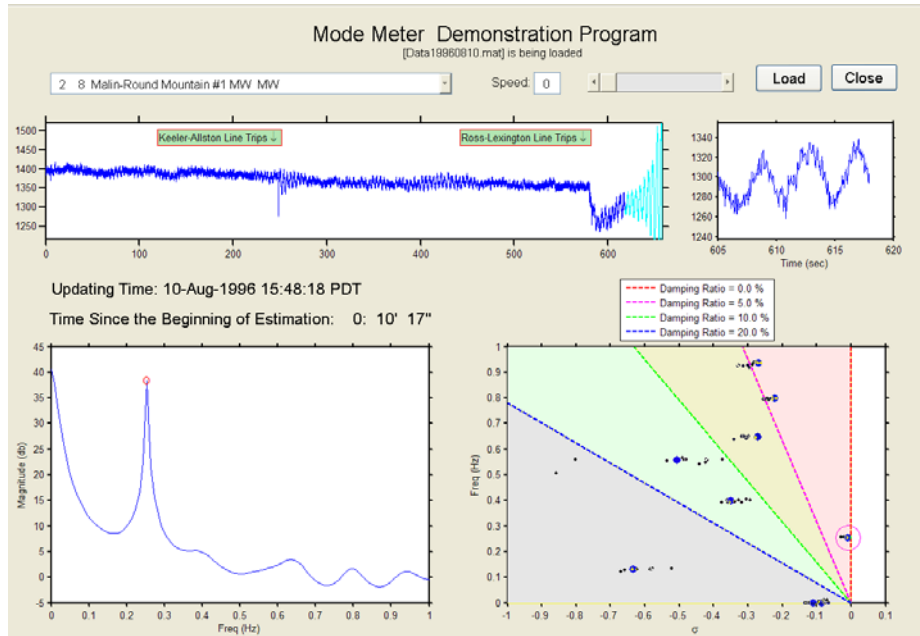

A prototype screen of a mode meter: top left — time plot of a critical signal, bottom-left — spectral energy, and baseline will be added, bottom right — oscillation frequencies and damping, alarm lines included.

Synchrophasor data applications have proven effective for oscillation monitoring but these do not yet have a lengthy history of use and testing. Thus current oscillation monitors are used to inform and alert operators but they are not yet considered “production grade.” Since oscillation monitoring is a principal goal of both Eastern and Western interconnection SGIG projects, it is probable that the use, refinement, testing and research of these applications and the data collected over the next three years will yield high-quality, highly reliable oscillation monitoring applications within a few years.

Several mode meters exist today, but not all of them have satisfactory performance. There is need to develop benchmarking cases to verify mode meter accuracy in a realistic power system environment.

Some resources for oscillation monitoring and controls include:

- Mode Meter: <http://eioc.pnl.gov/research/gridstability.stm>
- Dan Trudnowski – Mode Meter
<http://ieeexplore.ieee.org/Xplore/login.jsp?url=http%3A%2F%2Fieeexplore.ieee.org%2Fiel5%2F59%2F4494587%2F04476159.pdf%3Farnumber%3D4476159&authDecision=-203>
- Dan Trudnowski – Mode Shapes
<http://ieeexplore.ieee.org/Xplore/login.jsp?reload=true&url=http%3A%2F%2Fieeexplore.ieee.org%2Fiel5%2F59%2F4374138%2F04494758.pdf%3Farnumber%3D4494758&authDecision=-203>
- PhasorPoint – Oscillatory Stability Monitoring by Psymetrix

- http://www.naspi.org/toolRepository/tool_details.aspx?tid=65
- <http://www.psymetrix.com/products/phasorpoint-applications/oscillatory-stability-monitoring.html>
- TVA – oscillation monitoring
http://www.naspi.org/meetings/workgroup/2008_march/session_one/tva_oscillation_monitoring_venkatasubramanian.pdf
- Prototype implementation of Oscillation Monitoring System at TVA
http://www.naspi.org/meetings/workgroup/2008_october/presentations/08_wsu_oms_synchrophasors_mani_20081016.pdf
- SCE – Power System Outlook off-line analysis tool to view MW, MVAR, voltage, currents, modal oscillations and their damping
http://www.naspi.org/meetings/workgroup/2007_may/presentations/spms_monitor_trans_sce.pdf
http://www.naspi.org/resources/training/2008_0122/rtdms_training_package.pdf
- Pacific DC line event identified and addressed based on phasor monitoring
http://www.naspi.org/meetings/workgroup/2009_february/presentations/quanta_phasor_measurements_wecc_martin_20090204.pdf
- Phasor Grid Dynamics Analyzer (PGDA) program to view and analyze modal oscillations and damping
http://www.naspi.org/resources/training/2008_0801/phasor-grid_dynamics_analyzer_training080108.pdf
- UCTE – CENTREL study on inter-area oscillations
Breulmann H., et al., “Analysis and Damping Inter-Area Oscillations in the UCTE/CENTREL Power System,” CIGRE Session 2000, No. 38-113
- China Southern Grid – implemented a control application for HVDC control for oscillation damping
Li Peng; Wu Xiaochen; et al., "Implementation of CSG's Wide-Area Damping Control System: Overview and experience," Power Systems Conference and Exposition 2009, PSCE '09. IEEE/PES, pp.1-9, 15-18 March 2009

4.1.4 Voltage monitoring and trending

Phasor systems can be used to monitor, predict and manage frequency and voltage on the bulk power system. One of the most promising near-term synchrophasor applications is for trending system voltages at key load center and bulk transmission busses.

Voltage trending and voltage instability prediction are highly desirable uses for synchrophasor systems and a high priority for phasor data applications. Many transmission systems are voltage stability-limited, and voltage collapse can happen very quickly if stability limits are reached. Voltage instability occurs when either: (a) the system has inadequate reactive reserves, or (b) the transmission system cannot deliver reactive power from the source to where it is needed. Monitoring system voltage using phasor measurements of voltage profile, voltage sensitivities, and MVar margins allow operators to watch voltage levels in real-time, while a trending application would provide an early indication of voltage instability vulnerability.

Voltage trending visualization should remain “green” or stable as long as voltages stay within appropriate limits, but alert or alarm when voltage moves outside the limits. While long-term voltage trend duration (already provided by SCADA) is one hour, phasor measurements could be used to create short-term voltage trending (about one minute duration). A voltage display should

have an intelligent pre-processor to recognize data drop-outs and prevent zero-voltage reports (as from a missing PMU) from causing false alarms.

Reactive reserve monitoring is a closely related tool. Low voltages are indicators of low reactive support. Synchronous generators (operating in voltage control mode), shunt capacitors and static Var compensators provide primary reactive power reserves in the system. Studies can determine the amount of reactive reserves needed in various parts of the system, and be used to set appropriate alarms when the reactive reserves are low. Corrective actions are needed to address reactive needs, such as deploying condensers, adding shunt capacitors, requesting additional reactive support from the generation fleet and reducing flows on transfer paths.

Reactive reserves measurement and operation are becoming more important with the growing penetration of intermittent generation. Additional synchrophasor measurement at wind sites is necessary to ensure that system operators know how much of reactive reserve is primary and how much is secondary, as well as deliverability of the reserves during a disturbance. The above methods should also be reviewed and applied in major load centers.

Both voltage trending and reactive reserve monitors are mature applications — for instance, BPA has been using reactive reserve monitors since 1997 for lower Columbia plants. Some leading studies and applications of voltage trending and monitoring are described in these sources:

- C. W. Taylor and R. Ramanathan, “BPA Reactive Power Monitoring and Control following the August 10, 1996 Power Failure,” Invited paper, VI Symposium of Specialists in Electric Operational and Expansion Planning, Salvador, Brazil, May 24–29, 1998.
- PMU-based voltage stability analysis of power transfer paths
http://www.rpi.edu/~vanfrl/pdfs/PosterGallery/LV_2006IEEEGM.pdf
- ABB PSGuard system for angle difference monitoring, voltage stability monitoring, line thermal monitoring across corridors.
<http://phasors.pnl.gov/Meetings/2004%20March/Vendor%20Material/ABB/EIPP%20-%20Pres%20ABB%20PSGuard%20WAMS%20System.pdf>
- Expected/Realized phasor data benefits
<http://www.phasorrdms.com/downloads/presentations/PhasorTechResearchroadmap.pdf>
http://phasors.pnl.gov/Meetings/2006_may/presentations/imhoff_ercot_update.pdf
http://pepei.pennnet.com/display_article/260824/17/ARTCL/none/none/1/Wider-acceptance-for-WAMS/
- LIPA – Application of synchrophasors to predict voltage instability
<http://ieeexplore.ieee.org/iel5/4064641/4064642/04064666.pdf?arnumber=4064666>

PMUs are not critical for voltage trending and reactive reserve monitoring, as these functions can be performed using SCADA information. But phasor data is needed for monitoring voltage to reactive power sensitivities and voltage to active power sensitivities that can be indicators of the system approaching the edge. Innovative methods of using synchrophasor data in prediction voltage collapse are addressed in:

- Glavic, M. and Van Cutsem, T., Wide-Area Detection of Voltage Instability From Synchronized Phasor Measurements
<http://ieeexplore.ieee.org/Xplore/login.jsp?url=http%3A%2F%2Fieeexplore.ieee.org%2F>

- C. DeMarco, Situational Awareness: Singular Value Methods for PMU Data Interpretation, PSERC seminar March 2010.

4.1.5 Alarming and setting System Operating Limits; Event detection and avoidance

Studies of disturbances have shown that relative phase angles in the West strongly correlate with overall system stress and the system susceptibility to inter-area oscillations. Analyses in both east and west indicate that the rate of change of the phase angle difference is an important indicator of growing system stress; fast phase angle rate of change was a precursor for the 2003 Northeast blackout and the 2008 Florida blackout, so this can be used as the basis for operator alarms. One goal for a phasor data situational awareness and trending tool is to have it trend phase angles against phase angle limits, to warn operators when system stress is increasing. Such a tool should offer operator intelligence, so that when phase angles exceed critical limits, operators are given options such as increasing or activating reactive power reserves, inserting series capacitors, or modifying path flows.

To date few phasor data applications provide trusted alarming capabilities; further research and baselining is needed to fully develop this capability.

- WECC Merging PMU, operational and non-operational data for interpreting alarms, locating faults and preventing cascades
http://www.naspi.org/meetings/workgroup/2009_june/presentations/kezunovic_tamu_merging_pmu_20090604.pdf
- Red Electrica de Espana (REE) - S. Lopez, J. Gomez, R. Cimadevilla, and O. Bolado, "Synchrophasor applications of the national electric system operator of Spain," in Protective Relay Engineers, 2008 61st Annual Conf., April 2008, pp. 436–456.

4.1.6 Resource integration

Phasor measurement systems with real-time data are expected to be particularly useful for better monitoring, managing and integrating power plants into the bulk power system. Integration challenges include how to identify and respond to the variability of renewable and distributed generation. The ARRA projects undertaken by WECC, ERCOT, MISO and PJM are all targeting resource integration as a particular technical goal.

Because many renewable technologies are intermittent and highly variable, real-time PMU-based monitoring can improve regulation and load-following using dispatchable conventional generation, storage and demand-side resources. PMUs installed at wind generation collector points can provide instantaneous data to the system operator. This can help in acquiring generation resources that can be ramped up or down, to meet the energy balance requirements, taking into consideration the wind variability. The California ISO and ERCOT plan to use phasor data for better monitoring of variable generation in real-time and integrate renewable resources economically while maintaining bulk power system reliability. This application is still in a conceptual stage and will require R&D efforts.

Intermittent generation such as wind and solar reduce the overall inertia of the interconnected system. This degrades the governing frequency response and alters the modal frequency behavior of the interconnected system, and could adversely impact the grid's transient stability performance. High-speed PMU-based monitoring provides operators better situational

awareness and visualization of actual variable output and its effects (along with all other resources) on the bulk power system, and thus allows better grid management and responsiveness. Over time, phasor data could be used for automated control of physical system actions, including generator balancing energy and reactive power production, demand response and storage, and for intelligent protection and operations and maintenance decision support to effectively manage and maintain generation-load balance.

One key to renewables integration is improving prediction of intermittent generation and understanding how individual plants and fleets of generators perform. Phasor data offer better location- and time-specific datasets on technology and plant performance over time, and thus can be used to improve generation prediction and turbine and plant performance models, as well as to improve modelers' understanding of how these resources affect the interconnected grid.

Several sources of information on the use of synchrophasor technology for resource integration include:

- California Public Interest Energy Research in phasor measurement application
http://www.naspi.org/meetings/workgroup/2008_march/session_two/cpi_energy_research_brown.pdf
- CIEE- transmission technology research for renewables integration
<http://ucciee.org/piertrans/documents/TransmissionTechnologyResearchforRenewablesFinalReport.pdf>
- Denmark – monitoring wind power plant operation
http://www.iceo.be/eow2007/calendar_site/info2.php?id=105&id2=162&ordre=77
- EnerNex Corporation – wind generation modeling
http://www.naspi.org/meetings/workgroup/2010_february/presentations/thursday_renewables/zavadil_enernex_renewables_20100225.pdf
- BPA – wind generation modeling and monitoring
http://www.naspi.org/meetings/workgroup/2010_february/presentations/thursday_renewables/kosterev_bpa_renewables_20100225.pdf
- California ISO – integrating wind generation
http://www.naspi.org/meetings/workgroup/2010_february/presentations/thursday_renewables/mcintosh_caiso_renewables_20100225.pdf
- CCET – Technology Solutions for Wind Integration
http://www.naspi.org/meetings/workgroup/2010_february/presentations/thursday_renewables/holloway_ccet_renewables_20100225.pdf
- ERCOT – phasor measurements
http://www.naspi.org/meetings/workgroup/2010_february/presentations/thursday_renewables/woodfin_ercot_renewables_20100225.pdf

4.1.7 State estimation

Snapshots of data from PMUs can be integrated into an orthogonal state estimator by feeding PMU measurements (e.g., voltage and current) directly into the state estimator measurement vector and the Jacobian matrix it uses to solve the network. Alternatively, a state estimator can use derived PMU measurements of voltage angle differences and branch factor angle measurements, thus eliminating the requirement for synchronizing state estimator and PMU angle references. This approach enables the state estimator to calculate the network solution based on both PMU and conventional measurements simultaneously, with the advantage that the phasor data offer redundant system condition measurements and enable better solution accuracy.

Conventional state estimator inputs include MW, MVar, KV, Amp and Taps; phasor data fed into a state estimator include voltage angles at buses and current angles at branches. All phasor data fed into the state estimator are obtained for a single point in time (e.g., one dataset is extracted from the PDC's phasor data flow every five minutes, since the state estimator solves at a far slower rate than PMUs sample). Multiple snapshots of PMU data taken at different times, representing different system loading and topology conditions, may be needed to fully test a PMU-integrated state estimator.

Some of the entities using phasor data for state estimation, and references to their work, include:

- SDG&E –integrating phasor data into state estimator to better manage congestion
http://www.naspi.org/meetings/workgroup/2008_march/session_two/sdge_enhance_state_estimation_kondragunta.pdf
- TVA – On-line state estimator using PMUs
http://www.naspi.org/meetings/workgroup/2008_june/vendor/areva_activities_synchrophasor_giri.pdf
- Russia – Improved EPS state estimation using SCADA and PMU data
http://www.sei.irk.ru/articles/2006_10.pdf
- NYISO – Augmenting state estimation with phasor measurements
http://www.naspi.org/meetings/workgroup/2008_october/presentations/16_rpi_phasor_data_vanfretti_20081017.pdf
- Distributed State Estimator -SuperCalibrator Approach - Delivering Accurate and Reliable Data to All
http://www.naspi.org/meetings/workgroup/2009_june/presentations/meliopoulos_git_distributed_state_estimator_20090604.pdf
- BPA – Phasor Measurement Systems in Western North America
http://www.energo-info.ru/images/pdf/Rele/Session_4/S4-1.pdf
- PMU-Based Distributed State Estimation with the SuperCalibrator
http://www.pserc.org/cgi-pserc/getbig/generalinf/presentati/psercsemin1/4psercsemin/meliopoulos_pserc_teleseminar_pmu-dse_june17_2008.pdf
- Sevillana de Electricidad of Spain – enhanced state estimation using real-time data – Slutsker, I.W.; Mokhtari, S.; et al., "Implementation of phasor measurements in state estimator at Sevillana de Electricidad," Power Industry Computer Application Conference, 1995, Conference Proceedings 1995 IEEE, pp. 392-398, 7-12, May 1995.
- NYPA Enhanced state estimation work with EPRI and Siemens – Hirsch P., "NYPA investigates a next generation phasor-assisted state estimator at its energy control center," Innovations with EPRI Technology, No. 1011164, Jan. 2005, and Ghassemian, A. & Fardanesh, B., "Phasor assisted state estimation for NYS transmission system – Implementation & testing," Power Systems Conference and Exposition, 2009. PSCE '09. IEEE/PES, pp.1-8, 15-18 March 2009

4.1.8 Dynamic line ratings and congestion management

Phasor data can be used to monitor transmission line loadings and recalculate line ratings in real-time. Fixed seasonal summer or winter ratings are typically chosen based on fixed assumptions regarding ambient temperature, wind speed, and solar heating input to arrive at a conservative figure for transmission line conductor ampacity based on a maximum allowable conductor

temperature. But real-time phasor data for selected transmission lines can be used in combination with local weather conditions (ambient temperature and wind speed, which can vary widely along a long transmission line) to calculate the actual ampacity of a transmission line, which could be significantly greater than a conservative seasonal rating. Dynamic line ratings can be used to enhance throughput from facilities that constrain generator output, those that constrain service into load pockets, to relieve congestion and reduce congestion costs along key lines, and to monitor lines that serve intermittent generation.

Today the two methods used for real-time monitoring and dynamic line ratings are the CAT-1 system (distributed by The Valley Group), which directly monitors conductor tension and ambient temperatures and feeds these data to a utility EMS or off-line system (that already has sag-to-temperature and conductor characteristics data). The CAT-1 system has been used to avoid or reduce curtailment of firm and non-firm power contracts, integrate new wind generation, and reduce hydro-generator curtailments.

ABB's Line Thermal Monitoring application uses PMUs at each end of the target transmission facility, collects real-time voltage and current phasor quantities at each end, and calculates actual series impedance and shunt admittance to calculate actual average conductor temperature.

Both of these dynamic line rating methods are mature technologies that have been used in the field by numerous utilities. Addition of PMUs and phasor data will increase the precision and effectiveness of dynamic line rating applications. Reports and sources on the use of these methods and applications include:

- California Institute for Energy and Environment (CIEE): Phasor Measurement Application Study
http://www.naspi.org/resources/dnmtt/ciee_pmufinalreport_october06.pdf
- Path flow (MW/MVAR) configuration
<http://eetd.lbl.gov/certs/pdf/cec-500-2008-049-apf.pdf>
- Using phasors to enhance transmission reliability and capability
http://phasors.pnl.gov/resources_offline/PMU_ACDC_paper_DOE.pdf
- SCE – Synchronized Phasor Measurement System (SPMS) for monitoring transmission
http://www.oe.energy.gov/DocumentsandMedia/Synchronized_Phasor_Movement_Bhar_gava.pdf
- PMU-based voltage stability analysis of power transfer paths
http://www.rpi.edu/~vanfrl/pdfs/PosterGallery/LV_2006IEEEEGM.pdf
- ABB PSGuard system for angle difference monitoring, voltage stability monitoring, line thermal monitoring across corridors
<http://phasors.pnl.gov/Meetings/2004%20March/Vendor%20Material/ABB/EIPP%20-%20Pres%20ABB%20PSGuard%20WAMS%20System.pdf>
- The Valley Group – dynamic line ratings – a complimentary technology for synchrophasors
http://www.naspi.org/meetings/workgroup/2009_october/presentations/stelmak_valley_e_merging_apps_20091008.pdf

4.1.9 Outage restoration

System frequency is an indicator of system integrity. Bus frequencies are reliable indicators of power system islands and system separation points. Frequency information is also very important during the black-start and system restoration following break-ups; phasor data can be

used to bring equipment back into service without risking stability or unsuccessful reclosing attempts.

After Hurricane Gustav hit the Entergy service territory in 2008, so many of Entergy's transmission lines were damaged that a separate electrical island was formed within the heart of the service territory. Entergy's SCADA system did not detect this island, but its phasor data system revealed its existence by showing two distinct frequency plots. Once they recognized that their planned service restoration activities would compromise the operational integrity of the island, Entergy reevaluated and redesigned its restoration plan. The utility then used its phasor system to observe both the island and the rest of its service territory (watching the two frequency lines shown in Figure 4-6 below) as it executed a new restoration and synchronization plan that successfully resynchronized the island 33 hours later.

Figure 4-6 — Entergy system islanding after Hurricane Gustav, 2008

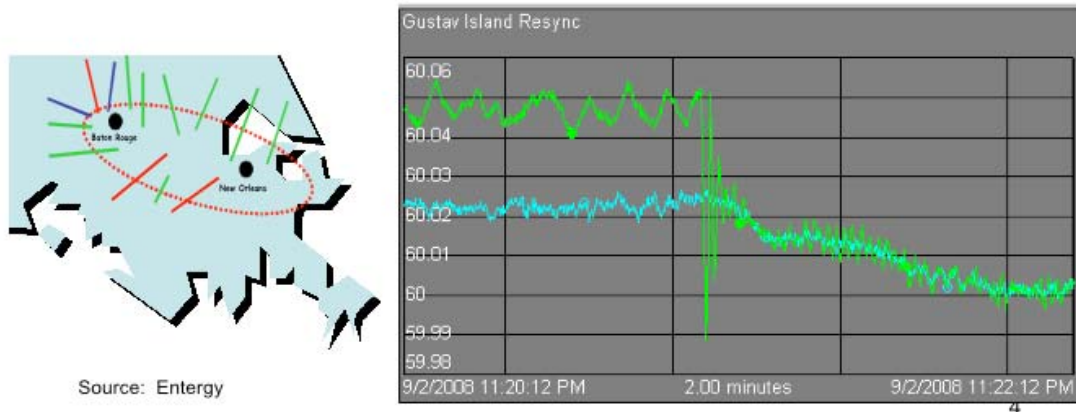

Resources that describe the use of synchrophasor systems for outage restoration include:

- Entergy – used phasor data for restoration after Hurricane Gustav
http://tdworld.com/overhead_transmission/role_phasor_data_emergency_operations_1208/index.html?smtc=wr
- UCTE – used phasor data system for system restoration after October 2004 European blackout
http://www.naspi.org/meetings/workgroup/2007_september/presentations/swissgrid_wam_sattinger09072007.pdf
- Salt River – Generator black-start validation using phasor data
<http://www.apqa.org/aug2005.htm>
http://www2.selinc.com/techpprs/6208_GeneratorBlack_RM_20070607.pdf

4.1.10 Operations planning

Phasor data offer great value for hour-ahead and day-ahead operations planning. These data can be used to improve models — both to refine models of individual assets and groups of assets (e.g., combustion turbines or wind power plants) to improve understanding and representation of interconnection-wide behavior. Phasor data snapshots of past system conditions can be used to improve development and analysis of system operating conditions under a variety of normal and potential contingency operating scenarios.

Phasor data can also be used to identify and diagnose odd system conditions or behaviors — for instance, BPA planners used phasor data to identify the fact that several of its generators were operating with their governors' automatic controls turned off.

Information about several uses of phasor data for operations planning can be found at:

- EPRI – Precursor signals of cascading outages based on visualization of PMU data
http://www.naspi.org/meetings/workgroup/2008_october/presentations/03_epri_precursor_signals_lee_20081016.pdf
- Synchronized Phasor Measurement Systems (SPMS) vision and challenges
http://www.naspi.org/meetings/workgroup/2007_may/presentations/spms_vision_challenge.pdf
- SCE - Use of Phasor Data for Real-Time Operations

http://www.naspi.org/meetings/workgroup/2009_june/presentations/botello_sce_grid_control_center_20090604.pdf

- BPA- Performance monitoring and model validation of power plants
www.naspi.org/meetings/workgroup/2009_june/naspi_wg_sacramento_agenda.pdf

4.2 Phasor Data Use for Planning (off-line applications)

Reliability starts with good planning. Availability and analysis of synchronized phasor measurements should improve understanding of power system performance and improve models used in power system studies. Ultimately these should produce better decisions on capital investment and more effective utilization of the transmission system.

4.2.1 Baselineing power system performance

Before we can build accurate system condition trending and predictive tools, it will be necessary to conduct extensive baselining analyses to identify and understand phase angles under a variety of system conditions. To be most useful and informative, these analyses require extensive records of phasor measurements across a large region, covering a wide variety of loads, equipment status, and other system conditions. Baselineing entails using historic grid condition data to correlate system performance relative to the measured angular separation. PMU data are then used to structure power system simulations to predict how system performance relates to the phase angles under large disturbance events; ideally, this is done using system models that have already been calibrated and validated with phasor data to improve their predictive capability.

The activities that are part of baselining include:

- Calculating system performance indicators
 - frequency response performance (such as the size of generation outage, pre-disturbance frequency, dip frequency, settling frequency, time of the outage)
 - oscillation performance - frequency, damping, energy, mode shape
 - voltage stability indicators
 - power-angle sensitivities
- Recording power system measurements that best indicate system stress
 - total generation in an interconnection
 - phase angles
 - generation clusters
 - powerflow on key flow gates
 - reactive reserves
- Recording power system measurements that reflect system stress

Baselineing needs to be done at the interconnection, control area, and power plant levels. Baselineing will be used for various applications, such as tracking system performance over time, detecting acute changes in system performance, and validating models that are used in studies to set system limits. While baselineing of power flow conditions is possible with SCADA measurements, baselineing of power system dynamic performance (oscillations, frequency response, power-angle sensitivities) is possible only with the high-speed synchronized data that PMUs collect.

Baselineing studies are under way in both the Eastern and Western interconnections. Phase angle information derived from these studies could be used to determine alarm settings for system

trending and wide-area monitoring and visualization tools. Phasor data are also being used for pattern recognition exercises, which look at system conditions and anomalies to attempt to identify precursor indicators for grid disturbances without using system simulation models.

Figure 4-7 shows an example of frequency response baselining in the Western interconnection.

Figure 4-7 — An example of frequency response baselining in the Western interconnection

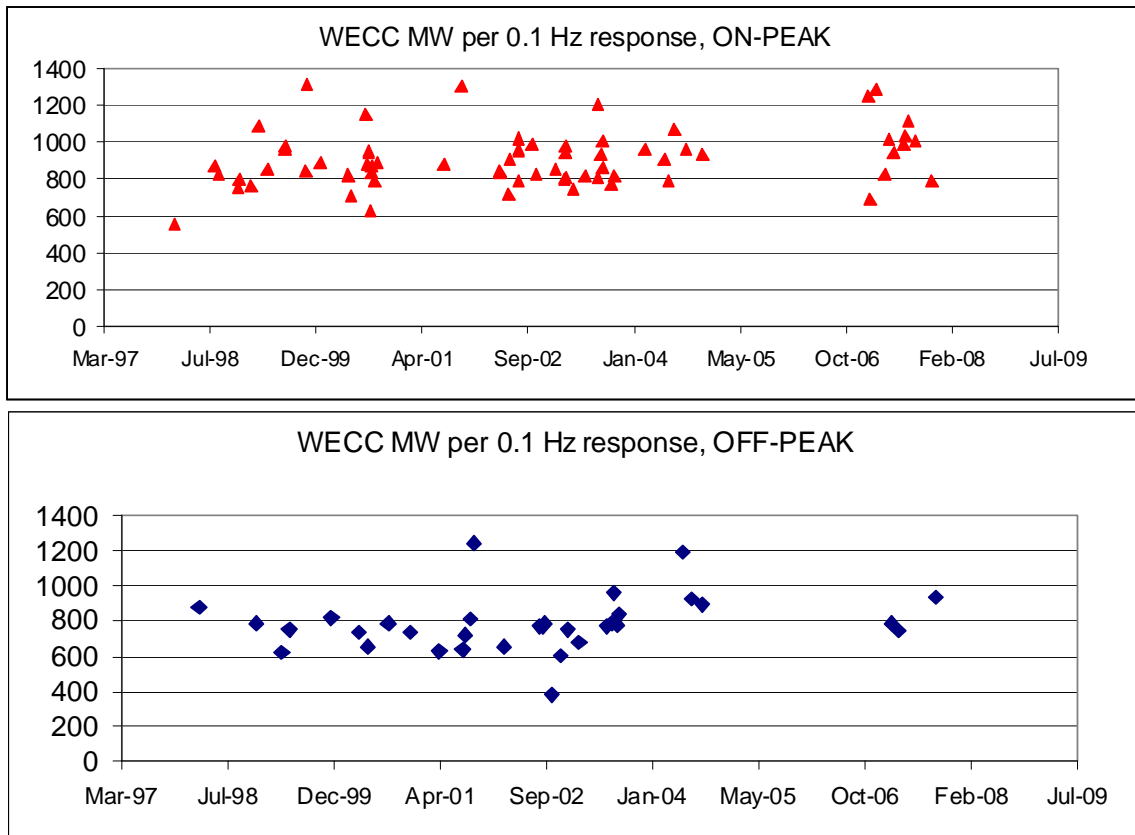

Baselining activities are very high priority. These applications are at a prototype stage but should be ready to inform phasor-based wide-area model validation, trending and operator intelligence tools within five years.

Resources that provide more information on these topics include several items posted by the NASPI Planning Implementation Task Team and at:

- NASPI PITT – <http://www.naspi.org/resources/pitt/pittresources.stm>
- Staged System Tests for Validation of WECC System Performance and Modeling <http://www.transmission.bpa.gov/business/operations/SystemNews/HVDCprobesAug08/SummaryReportD.doc>

4.2.2 Event analysis

Synchronized wide-area data is essential for disturbance analysis, as evidenced by the August 14, 2003 blackout investigation. Data synchronization is critical for the sequence of event reconstruction, particularly for complex events where many switchings occur in short time frame. The data required for event analysis includes:

- bus voltages, angles and frequencies at key transmission substation
- powerflow on key transmission paths and flowgates
- active and reactive power output, voltage and frequency of major power plants
- active and reactive power output, voltage and frequency of major controlled elements, such as HVDC systems and SVCs
- active and reactive power, voltage and frequency of several loads in a major load center
- status of circuit breakers.

The infrastructure being deployed by the various SGIG projects will greatly enhance event analysis capabilities for future disturbances.

Some examples of the use of phasor data for analyzing grid disturbances include:

- UCTE – November 2006 European disturbance
http://www.naspi.org/meetings/workgroup/2007_september/presentations/swissgrid_wam_sattinger09072007.pdf
- NERC –Florida 2007 disturbances
http://www.nerc.com/news_pr.php?npr=36
http://www.naspi.org/meetings/workgroup/2008_march/session_two/vt_online_event_location_liu.pdf
- WECC Dynamic Probing Tests: Purpose and Results
http://www.naspi.org/meetings/workgroup/2008_october/presentations/12_mttech_wecc_dynamic_trudnowski_20081016.pdf
- C. Taylor & D. Erickson, “Recording and Analyzing the July 2 Cascading Outage,” IEEE Computer Applications in Power, vol.10, no.1, pp.26-30, January 1997

4.2.3 Static system model calibration and validation

Planners are using phasor data to improve static system models. The high-speed observations of grid conditions allow modelers to calibrate models to better understand system operations, identify errors in system modeling data or in model algorithms, and fine-tune the models for on-line and off-line applications (power flow, stability, short circuit, OPF, security assessment, modal frequency response, and more).

These resources offer more information about some uses of phasor data for static system model calibration:

- Simulation of Wide Area Frequency Measurements from Phasor Measurement Units (PMUs) or Frequency Disturbance Recorders (FDRs)
http://www.naspi.org/meetings/workgroup/2009_june/presentations/radman_ttu_simulation_wide_area_frequency_20090604.pdf
- Entergy Phasor Project, Enhanced Wide-Area Visibility: Finding Value in Phasor Measurement
<http://www.powerworld.com/Presentations/UsersGroup200506/12%20EIPP%20Galvan.pdf>
- WECC - Use of the WECC WAMS in Staged System Tests for Validation of System Performance and Modeling
http://phasors.pnl.gov/Meetings/2007_may/presentations/wecc_wams.pdf

4.2.4 Dynamic system model calibration and validation

Grid planning and operating decisions rely on simulations of the dynamic behavior of the power system. Both technical and commercial segments of the industry must be confident that the dynamic simulation models and database are accurate and up to date. Inaccurate, over-optimistic models can lead operators into unsafe operating conditions and that produce widespread power outages, as occurred in the summer of 1996 in the Western Interconnection. On the other hand, pessimistic models and assumptions can lead to conservative grid operation and under-utilization of transmission capacity, thereby inhibiting economic generation dispatch. Therefore, having realistic models is very important to ensure reliable and economic power system operation.

Periodic system model validation is necessary to ensure that the power system models are accurate and up to date. Disturbances and system tests present great opportunities for model verification and identification of the model improvement needs. Over the past 12 years, the quality of the dynamic models and databases has improved immensely in the West, due to interconnection-wide model validation efforts.

Looking forward, there are several ways to improve the model validation process:

- Development of the validation base cases – A validation base case is used as a starting point for dynamic simulations. Experience shows the base case must be reasonably close to the actual system conditions. Manual processes have been used to create the validation base cases, but this process is prone to errors and very time consuming; without readily available base cases, model validation studies are less often performed. However, modelers are beginning to use state estimator cases in the base case development process; mapping dynamic database onto state estimator base cases is one of the highest priorities for enabling the process of using state estimator cases for model validation.
- Availability of interconnection-wide synchronized disturbance recordings – New SGIG synchrophasor infrastructure will provide wide-area synchronized data that are essential for model validation. Synchronization is also critical for the sequence of event reconstruction, particularly for complex events. Wide-area synchronized data is also essential for analysis of inter-area power oscillations, particularly calculation of oscillation mode shapes. Data on key power plants and controllers improves event analysis and simulations.
- Tools for model analysis – It is very common that initial validation model runs don't match actual disturbance recordings. The causes of mismatch include different powerflow conditions, incorrect sequence of events, un-modeled controllers and protection elements, mis-represented operational practices, or bad model data. The first step, therefore, is to validate as many model components as practical. Playback functions are currently available in the grid simulators. The function allows playback of recorded boundary conditions (voltage and frequency) in the dynamic simulation to validate the model response. Recorded active and reactive power is used as "measures of success." Once individual model components are validated, the system model validation can focus on the remaining elements. System model adjustments require engineering judgment to determine which system model components may need to be adjusted. Sensitivity studies are necessary to determine the effect of system model changes.

Some sources on system model validation and the use of phasor data for this purpose include:

- NERC White Paper on System Model Validation (draft at <http://www.nerc.com/docs/pc/mvtf/MV%20White%20Paper%20Draft%205-28.pdf>)
- D.N. Kosterev, C.W. Taylor & W.A. Mittelstadt, “Model Validation for the August 10, 1996 WSCC System Outage,” IEEE Transactions on Power Systems, vol.14, no.3, pp.967-979, August 1999
- WECC Dynamic Probing Tests: Purpose and Results http://www.naspi.org/meetings/workgroup/2008_october/presentations/12_mttech_wecc_dynamic_trudnowski_20081016.pdf
- Model parameter calibration using recorded dynamics http://www.naspi.org/meetings/workgroup/2008_october/presentations/14_pnnl_modelvalidation_huang_20081016.pdf
- California Institute for Energy and Environment (CIEE): Phasor Measurement Application Study http://www.naspi.org/resources/dnmtt/ciee_pmufinalreport_october06.pdf
- Model parameter calibration using phasor data for WECC’s Palo Verde model http://www.naspi.org/meetings/workgroup/2008_october/presentations/14_pnnl_modelvalidation_huang_20081016.pdf

4.2.5 Power Plant Model Validation

Power plant model validation has been one of the most successful applications of synchrophasor data to date. Disturbance monitoring enables periodic verification of the generator model performance. General Electric implemented a disturbance playback function in its PSLF grid simulator in 2001, giving a capability to use disturbance recordings for model performance validation. There is a long list of success stories, including:

- Disturbance recordings pointed out modeling deficiencies of the governor response at lower Columbia generators in the Pacific Northwest, which led to the discovery of inappropriate modeling of hydraulic turbines at these projects, and the development of Kaplan hydro-turbine models in 2001–2003.
- Disturbance recordings were very useful in identifying PSS responses at Centralia coal-fired and Boundary hydro plants. Disturbance monitoring was used to validate generator performance for grid disturbances in 2003–2005.
- Governor response validation done by the WECC Governor Modeling Task Force in 2003.
- Identifying control issues with Colstrip power plant in 2003.
- Identifying control failure at Grand Coulee power generators in 2009.
- A large number of generator model validation studies over the last ten years confirming the model validity.

The tools for power plant model verification are mature. The set-up process is manual at this time, and automation is highly desirable. Some references on this topic include:

- J. Undrill, L. Pereira, et al., “Generating Unit Model Validation: WECC Lessons and Moving Forward,” 2009 General IEEE PES Meeting in Calgary, AL.
- S. Yang, “Performance Monitoring and Model Validation of Power Plants,” presentation at June 2009 NASPI meeting http://www.naspi.org/meetings/workgroup/2009_june/presentations/yang_bpa_perf_monitoring_model_validation_20090604.pdf

- D. Kosterev, "Hydro-Turbine Model validation in Pacific Northwest," IEEE Transactions on Power Systems, vol.19, no.2, pp.1144-1149, May 2004.
- Model parameter calibration using phasor data for WECC's Palo Verde model http://www.naspi.org/meetings/workgroup/2008_october/presentations/14_pnnl_modelvalidation_huang_20081016.pdf
- C. Huitt, D. Kosterev, J. Undrill, "Dynamic Monitoring is Cost Effective for TransAlta, BPA," Electric Light and Power vol.82-07, p.52, November/December 2004.
- Z. Huang, T. Nguyen, et al., "Model Validation of Power System Components Using Hybrid Dynamic Simulation," Proceedings of PES-TD2005/2006 – IEEE Power Engineering Society Transmission & Distribution Conference and Exposition 2005/2006, Dallas, USA, May 21-24, 2006.

4.2.6 Load Characterization

Loads are playing a larger role in power system stability due to on-going changes in load composition: the proportion of compressor (air-conditioning and heat pump) and electronic loads is growing, and that of resistive loads (incandescent lighting, space and water heating) is shrinking. Resistive-type loads are energy-inefficient but have favorable voltage characteristics (the power is reduced proportional to voltage squared). Compressor motor and electronic loads behave as constant power loads with respect to voltage and therefore maintain their demand when the electrical grid is in trouble. Single-phase residential air-conditioners can stall during a fault, basically becoming a high-impedance locked rotor fault.

Fault-Induced Delayed Voltage Recovery (FIDVR) has received significant attention in recent years. FIDVR is a phenomenon related to stalling of motor loads (primarily residential single-phase air-conditioners) in the area close to a transmission fault, where transmission voltages remain at significantly depressed levels (70 to 85% of pre-disturbance) for several seconds after the fault is cleared. Multiple FIDVR occurrences have been observed in Southern California, Florida and the Southeast since late 1980s. A severe FIDVR event can lead to fast voltage collapse, and this risk is increasing in large metro areas, particularly as new generation is sited far away from large load centers.

Better load modeling is needed, and that will require better load data and extensive model validation. WECC's Load Modeling Task Force is completing a multi-year effort on developing and implementing a composite load model. That model has reproduced (in principle) historic FIDVR events, and will now be used for voltage stability assessments.

Synchrophasor data is invaluable for understanding and modeling loads in power system studies, particularly the FIDVR phenomenon. Where specific loads can be identified on the system, PMUs installed at sub-transmission levels can collect data on those loads' responses to actual frequency events, and use these data to improve load modeling.

Southern California Edison has successfully used phasor data from load locations for load model calibration and tuning, as shown in Figure 4-8.

Figure 4-8 — SCE’s load model results before and after calibration with phasor data

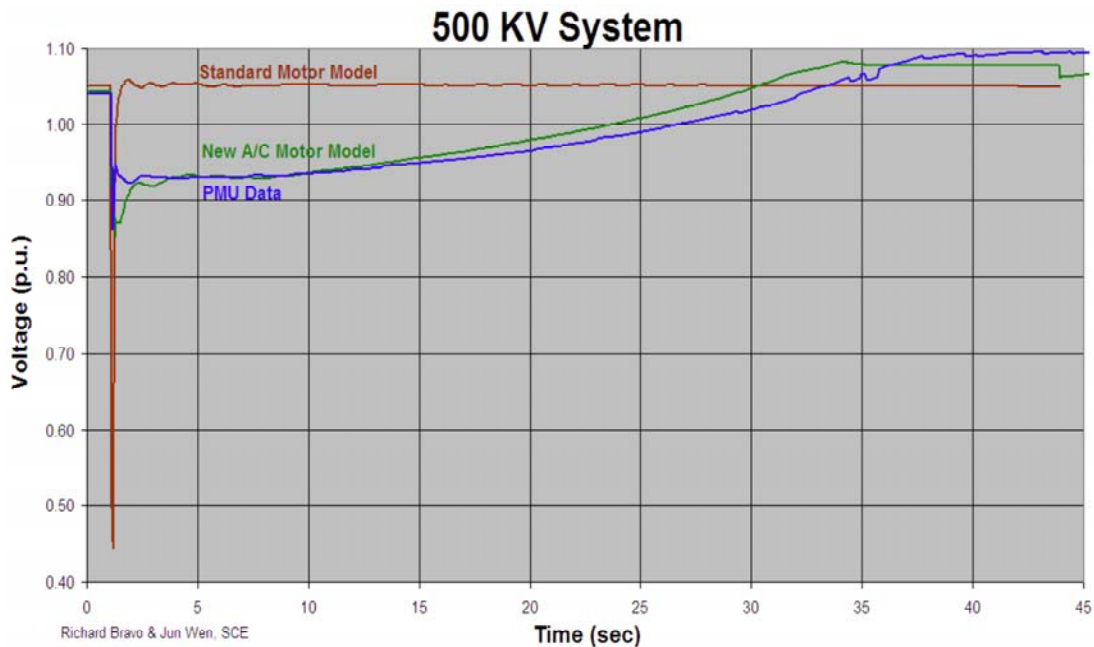

Upcoming efforts for high-level load model verification include work to estimate system loads’ sensitivity to frequency from small step changes in frequency due to very small generation trips. Additionally, there will be work to estimate real-time load sensitivity to voltages. Most on-line voltage stability tools use constant P, constant Q load for post-transient voltage stability, such as PV and VQ curves based on voltage stability limits. If only a portion of the load (say 20%) at the critical bus operates at constant current or constant impedance, we can gain significant benefit in the voltage stability limit.

Some references on this topic include:

- B. Williams, W. Schmus, D. Dawson, “Transmission Voltage Recovery Delayed by Stalled Air Conditioner Compressors,” IEEE Transactions on Power Systems, vol.7, no.3, pp.1173-1181, August 1992.
- J. Shaffer, “Air Conditioner Response to Transmission Faults”, IEEE Transactions on Power Systems, vol.12, no.2, May 1997, pp.614-621.
- G. Chinn, “Modeling Stalled Induction Motors,” presented at the IEEE Transmission and Distribution Conference, Dallas TX, May 2006.
- NERC, White Paper on Fault-Induced Delayed Voltage Recovery
- D. Kosterev, A. Meklin, et al., “Load Modeling in Power System Studies: WECC Progress Update,” 2008 Power Engineering General Meeting, Pittsburgh, PA, July 2008.
- EPRI, “Measurement-Based Load Modeling,” ID 1014402, September, 2006
- R. Bravo, J. Wen, et al., “WECC Air Conditioner Motor Model - Test Report,” available from wecc.biz.

4.2.7 Special protection schemes and islanding

Phasor data can be used to design and test special protection schemes (SPS) and islanding. Ultimately it may be possible to use real-time phasor data that reveals the location and causes of

system stress to drive automated control and execution of special protection schemes, including even the real-time design and operation of system islanding in the face of a potential cascade.

Resources that describe the use of synchrophasor systems for SPS and islanding include:

- Status and key challenges of wide-area protection and control
http://www.ee.iitb.ac.in/~npsc2008/NPSC_CD/Data/Oral/AIC2/p98.pdf
- Australia – stability monitoring avoided blackout
http://www.naspi.org/meetings/workgroup/2008_october/presentations/07_psymetrix_oscillatory_modeshape_wilson_20081016.pdf
- Synchronized measurement technology (SMT) for real-time wide area monitoring, protection, and control (WAMPAC)
<http://www.quanta-technology.com/Documents/Grid%20Synchronization.pdf>
- Japan – PMUs for emergency islanding and management
<http://www.ieee.org/organizations/pes/meetings/gm2008/slides/pesgm2008p-001133.pdf>
- California Energy Commission: PMU Applications Business Case Study
http://phasors.pnl.gov/Meetings/2006_september/tuesday/Business_Case_for_Phazor_Measurements.pdf
- Slow Coherency Based Controlled Islanding and Demonstration in WECC
https://events.energetics.com/v&c08/pdfs/RC_Adaptive_Islanding_Demonstration.pdf
- Hydro Quebec – Special Protections http://cigre2008.ece.umanitoba.ca/Session3B-Substation_Automation_&_Communication/562%20-%20Tholomier%20-%20The%20Future%20of%20Substation%20Automation.pdf
- Entergy - Phasor Measurement Units (PMU) Instrumental in Detecting and Managing the Electrical Island Created by Hurricane Gustav
http://www.naspi.org/meetings/workgroup/2009_june/presentations/galvan_entergy_gustav_pmu_electrical_island_20090604.pdf
- Brazil – Analysis of Events using Phasor Measurement - special protection schema & islanding
http://www.naspi.org/meetings/workgroup/2009_october/presentations/zimath_reason_analysis_events_20091008.pdf
- EPRI Report “Application of Phasor Measurement Units for Controlled System Separation,” 11/25/2009, ID 1017800
- EPRI Report “Controlled System Separation,” 11/21/2008, Product ID: 1015993
- EPRI Report “Phasor Measurement Unit-Based Out-of-Step Protection Scheme,” December, 2009, ID 1020377

4.2.8 Primary Frequency (Governing) Response

The importance of adequate primary frequency control (i.e. generation governing response) for reliable operation of an interconnected power system is well-documented.²³ AEP and others have used phasor data to assess the overall governing response of Eastern Interconnection by analyzing generator trip-out events.

Figure 4-9 shows an example of the use of phasor data to identify frequency change for the loss of TVA’s 1,052 MW Cumberland generator on June 23, 2007.

²³ See, e.g., May 2007 IEEE Report, "Interconnected Power System Response to Generation Governing: Present Practices and Outstanding Concerns."

Figure 4-9 — Frequency change as measured by four Eastern PMUs for loss of the Cumberland generator on June 23, 2007

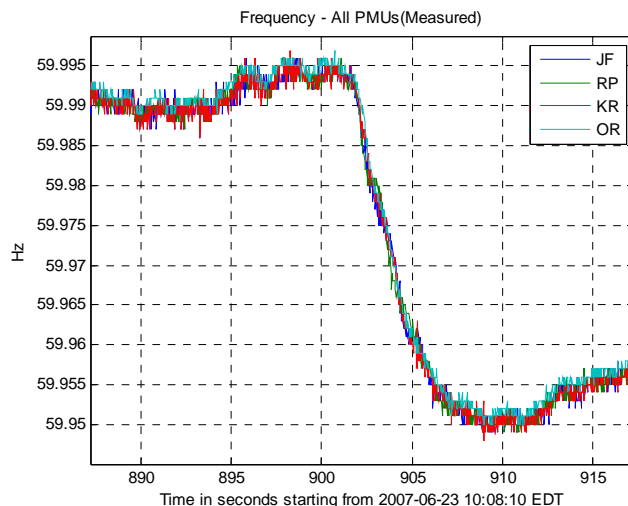

By continuously analyzing the generator trip-out events in an interconnection, the trend of governing response can be investigated. Such analysis can help in: 1) investigating primary frequency response of the interconnection for possible trends over time and for correlation with time of day, season, peak load, type of system event and other factors; and 2) identifying adverse impact, if any, of primary frequency response on interconnected network and develop solutions to address such impact, as appropriate. Based on this knowledge, simulation models used in planning studies can be improved to better represent the governing response routinely observed on large electric utility power systems.

- http://www.naspi.org/meetings/workgroup/2009_june/presentations/luigi_rpi_data_analysis_20090604.pdf

4.3 Wide-Area Controls

Wide-area synchronized measurements enable unprecedented opportunities for wide-area stability control applications. Wide-area measurements provide much greater observability of the system state, thereby leading to better and faster decisions. Since PMU measurements are instantaneous and have high resolution, phasor data can be used to activate local or centralized control of corrective measures for angular stability, voltage stability, low-frequency oscillations and thermal constraints. In California, phasor data drives the automated control of SCE's SVC device for local reactive power support; BPA plans to use phasor data for real-time stability and controls on a wider scale. Synchrophasor technology can help in moving from a localized control concept to a coordinated, centralized, wide-area control concept.

Phasor-driven wide-area controls has been a popular research topic in the last decade, including response-based SPS and inter-area oscillation damping to adaptive islanding. Yet very few control applications are now in use; this is the least mature set of applications, although it offers great benefit for grid reliability.

The following practical control applications, all requiring high-speed phasor data, are now under study:

- Fast Reactive Switching – Synchronous generators (in voltage control mode) and Static Var Compensators (SVC) provide reactive power reserves that can be deployed during the disturbances. Studies show strong correlation between the reactive margins on voltage stability-limited paths and reactive power response and reactive power reserves. Switching shunt in capacitors can be done to increase the reactive reserves of generators and SVCs. BPA is designing a response-based control scheme that monitors reactive output at key power plants to arm fast reactive switching of shunt capacitors and reactors for voltage support.
- Coordinated Secondary Voltage Control – It is not uncommon to have several reactive power resources in electrical proximity to each other. Coordination of voltage set-points is often required to ensure that appropriate reactive power reserves are maintained with equitable reactive sharing through secondary voltage controls. Synchrophasors or SCADA can be used for slow loop control, but with large-scale wind integration, there is greater need for fast coordination of voltage schedules among clustered wind power plants and switched capacitors to maintain dynamic reactive reserves.
- Inter-Area Oscillation Damping Controls – Wide-area oscillations can be dampened using automated controls, but this requires high-speed data and observability such as that offered by a synchrophasor system. After excessive oscillatory activity was observed during the 2006 summer heat wave, western grid operators are revisiting the feasibility of oscillation damping controls facilitated by phasor data.
- Equilibrium State Control – The power system must have a stable equilibrium (target state) to return to following a disturbance event. The more secure the target state, the more likely the system transient oscillation will be damped and the less strong oscillation control will be needed. In effect, the network and transfer demands are brought into balance to assure that there is a stable equilibrium (power flow) condition.

Control system engineering is paramount to the successful deployment of wide-area controls. Issues such as controller fault-tolerance, capability to perform with partial loss of data communications, controller testing, controller self-diagnostics, etc, need to be addressed. Wide-area controls should “do no harm” and controller robustness will be required under a variety of operating conditions, network topology changes, loss of measurements, etc.

It is very important to proceed at a measured pace with implementing wide-area controls, because of the risks that an automated controller could produce unintended consequences for grid operations.

Information on these uses can be found at:

- BPA – real-time stability controls
http://www.naspi.org/meetings/workgroup/2008_october/presentations/13_bpa_voltage_stability_kosterev_20081016.pdf
- Local and wide-area network protection systems
http://www.naspi.org/resources/archive/prtt/waps_wprc04.pdf
- Status and key challenges of wide-area protection and control
http://www.ee.iitb.ac.in/~npssc2008/NPSC_CD/Data/Oral/AIC2/p98.pdf

- Synchronized measurement technology (SMT) for real-time wide area monitoring, protection, and control (WAMPAC)
<http://www.quanta-technology.com/Documents/Grid%20Synchronization.pdf>
- SCE – closed loop control of SVC
http://www.naspi.org/meetings/workgroup/2008_march/session_one/sce_successful_utilization_johnson.pdf
- Static Var Compensation controlled via synchrophasors
<http://www.selinc.com/WorkArea/DownloadAsset.aspx?id=3487>
- Phasor data in protective relays for power system protection, control and analysis
<http://www.selinc.com/WorkArea/DownloadAsset.aspx?id=2613>
- Real-time power system control using synchrophasors
<http://www.selinc.com/WorkArea/DownloadAsset.aspx?id=3503>
- C. W. Taylor, "The Future in On-Line Security Assessment and Wide-Area Stability Control," Proceedings of IEEE Power Engineering Society 2000 Winter Meeting, 23-27 January 2000, Singapore.
- Hydro Quebec – Special Protections http://cigre2008.ece.umanitoba.ca/Session3B-Substation_Automation_&_Communication/562%20-%20Tholomier%20-%20The%20Future%20of%20Substation%20Automation.pdf
- I. Kamwa, L. Gérin-Lajoie, & G. Trudel, "Multi-loop power system stabilizers using wide-area synchronous phasor measurements," Proceedings of the 1998 American Control Conference, vol. 5, Philadelphia, PA, June 23-26, pp. 2863-2868.
- J. H. Chow, J. J. Sanchez-Gasca, et al., "Power system damping controller design using multiple input signals," IEEE Control Systems Magazine, vol. 20, no. 4, pp. 82-90, Aug. 2000.

4.4 Applications and Data Classes

Different phasor data applications have the different requirements for data exchange timeliness, which means that phasor data networks do not have to transport every piece of collected data simultaneously. Applications such as visualization tools for transmission operators, state estimators and other EMS tools, and inputs to automated wide area controllers require real-time streaming phasor data (published). In contrast, applications that use historical data, such as data for post-disturbance analysis and research (e.g., grid baselining) can access the data from data archives on a subscriber basis. Figure 4-9 shows the classes of phasor data services and their respective needs for data traffic handling.

Figure 4-9 — Classes of Phasor Data Services

NASPInet Traffic Attribute	Real-time streaming data			Historical data	
	CLASS A <u>Feedback Control</u>	CLASS B <u>Feed-forward Control</u>	CLASS C <u>Visualization</u>	CLASS D <u>Post Event</u>	CLASS E <u>Research</u>
Low Latency	4	3	2	1	1
Availability	4	2	1	3	1
Accuracy	4	2	1	4	1
Time Alignment	4	4	2	1	1
High message rate	4	2	2	4	1
Path Redundancy	4	4	2	1	1
Table key: 4 – Critically important, 3 – Important, 2 – Somewhat important, 1 – Not very important					

4.5 Phasor Applications, Alarm-Setting and Operator Training

Phasor technology enables high-level visibility across an entire interconnection. Time-synchronized, high-speed readings from across an interconnection let operators detect grid stresses in real-time, instead of waiting weeks for a disturbance post-mortem. Phasor systems reveal symptoms such as frequency transients, excessive angular separation, oscillations and low grid damping minutes to hours before major disturbances.

Phasors are a complement and an enhancement to current monitoring via SCADA. Standard human factors solutions used in the SCADA environment may not work. In general, there may be an event of interest in an interconnection every week and an event of consequence only a few times a year. Grid operators spend most of their time dealing with load-following, congestion management and voltage control. Thus, operators will likely provide little “real estate” for phasor-related displays. The challenge is then to find ways to get their attention when something significant is developing or has occurred.

When and how should you alert an operator? Post mortems of major events often show that anomalous conditions existed before the event, that operators could have responded to had they been alerted that conditions were unusual or degrading. Thus alarming is needed to alert the operator that something is abnormal. Any display or alert should be designed so that the operator can tell at a glance whether grid conditions are in a normal, abnormal (alert) or extremely abnormal (alarm) state. While the ideal case would be to have well-defined limits for monitored parameters based on engineering studies, these studies generally don't exist. Lacking studies, engineering judgment can be used to initially set alarm limits. In addition, there should be “soft” statistical limits to alert the operator that the system is in a state not seen in recent memory. NERC guidance is that operators should never let the grid remain in an unstudied state. If the angles, damping, oscillations or stress are abnormal, the operators and engineers should be alerted so they can either confirm that the power system is secure or take action to move it in a known state.

With good phasor data, analytical tools and sensible alarming, the challenge is then to assure that grid operators have the training to respond effectively to an alert and event. To understand the types of training needed by operators with regard to phasor technology, it's important to look at the different “modes” in which people perform the thousands of tasks of everyday life. Cognitive scientists have found that people perform at three separate levels. Figure 4-10 shows the three levels along with a comparison of an experienced and new operator.

Figure 4-10 — Levels of Human Performance

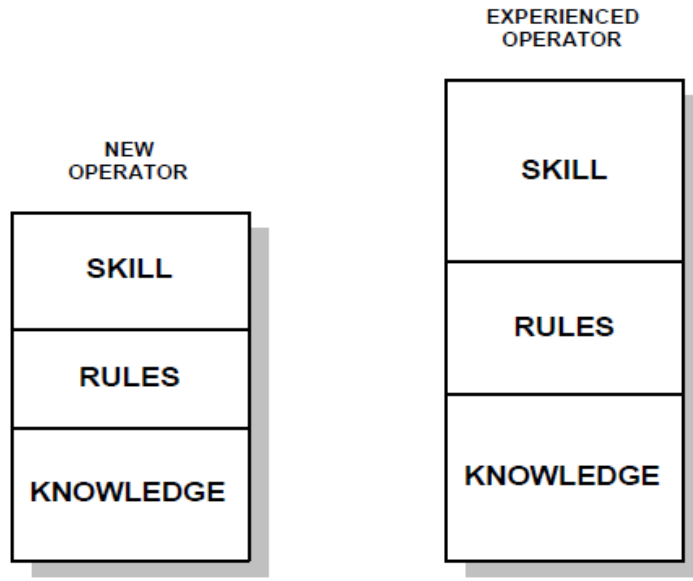

Skill-based performance can be thought of as computer subroutines that the mind stores by repeatedly doing a task. These programs are called into play without much thought and are done automatically. Consider the example person learning to drive a car with a manual transmission. When we are developing a skill, we start by ignoring all but one facet of the task. We initially focus on shifting and keeping the car running, ignoring speed, lane position, even other cars. Over time, the remaining skills are added to the subroutines, giving us smooth control of the vehicle. Eventually the large subroutine, “drive to work,” is done without much thought. These skill-based subroutines can be considered “autopilot” operation. This autopilot mode of performance is not bad. It frees our mind to plan while allowing us to accomplish a myriad of tasks that face us each day.

Skill-based training is best conducted locally, developing hands-on experience with tools the operator will be using day to day.²⁴

A person uses rule-based performance if a situation cannot be handled automatically by a stored skill. The rules are guidelines held in the person's memory. An example of an operating rule is, if voltage is low, put in a capacitor. Most of the time the rule works and the operator moves on to another task. If a new problem develops or if the low voltage isn't solved, the mind tries to use another rule. But if there is no known rule that can be applied, or if the problem can't be corrected by applying known rules, the operator must step up to the next level of performance (knowledge-based performance). The “6 C” templates described below are intended to develop the operator's toolkit of rules.

Knowledge-based performance occurs when the person draws upon all known concepts (as opposed to skills) in order to solve a problem. During knowledge-based operations, the only real

²⁴ See, for example, “Expert operator decision-making and the impact of PMUs,” at http://www.naspi.org/meetings/workgroup/2009_october/presentations/podmore_incsys_eodm_20091007.pdf.

way forward is through trial and error (enhanced by operator judgment and decision support methods such as analytical tools and supervisor advice). Success depends on defining the goal correctly, taking action, then recognizing and correcting deviations from the desired path.

As knowledge-based actions are taken, the situation gets worse, improves, or is solved. If the situation improves, the mind checks to see if any rules apply. If so, they are attempted, if not, the problem stays in the knowledge-based realm. The above cycle is repeated until the situation is “normal” and operator returns to skill-based performance. Because risk and effort is highest in the knowledge-based area, the ultimate goal of human nature is to solve the problem at hand and return to the least effort, skill-based level of performance.

Several resources can help operators increase knowledge-based performance with respect to phasor technology:

- The [EPRI Power System Dynamics Tutorial](#) is an excellent resource to help operators improve their knowledge on power system dynamics.
- The [NASPI Training Resource](#) website (see <http://www.naspi.org/resources/training/training.stm>)
- The [Bismarck State College](#) continuing education course on synchrophasors (see http://www.bsc.nodak.edu/energy/nc_nerc/)
- The [Real-Time Dynamics Monitoring System \(RTDMS\) Users' Group](#) has started posting training-related information on this visualization platform (see <http://www.rtdmsusersgroup.org/>).

As a first attempt to put some level of structure to phasor-related training, the NASPI Operations Implementation Task Team (OITT) created a “6 C” template. The template is a word document intended to let any contributor draft and share a phasor training reference. The templates can be built around a system phenomenon or an actual event. The template uses the following structure:

1. Concepts are the underlying principles involved in the situation or event.
2. Cues are the signals (readings or alarms) the operator would get leading up to and during the event or situation.
3. Causes are the precursors or conditions that trigger the event.
4. Consequences are the outcomes if the situation isn't controlled or mitigated.
5. Controls and Corrections are steps the operator can take to reduce the likelihood of an event or to efficiently respond should the situation occur.
6. Cases are event files, snapshots or post-mortems of actual situations.

The OITT has posted a few “6 C” templates on the NASPI website.²⁵ Additional “6 C” templates will be needed to help operators identify and respond to system events and phenomena such as excessive angular separation, local and inter-area oscillations, frequency excursions due to large unit trips or major load loss, or islanding events. With expanded PMU coverage, each interconnection should collect data on such events and establish a repository of system event cases that can be used to develop training material and job aids for operators. More research, modeling and event documentation using phasor data should allow trainers, operators and engineers to improve skills-, rules-, and knowledge-based training resources for operators; this should include more operator training on power system dynamics.

²⁵ See the December 2009 material at <http://www.naspi.org/resources/training/training.stm>.
Real-Time Application of Synchrophasors for Improving Reliability
10/18/2010

Chapter 5 — Conclusions, Recommendations and the Path Forward

5.1 Synchrophasor Technology Priorities for Operators

What applications or uses do operators want first from synchrophasor technology? According to the RTBPTF, they want improved wide-area situational awareness and visualization tools based on fast, real-time data, with alarming and intelligent decision-support tools to help them better understand what the problem is and identify the most useful options to respond. As discussed in the preceding chapters, synchrophasor systems should be able to meet most of these desires with high-speed, high-quality, and high-accuracy tools within a few years at most.

This chapter discusses the priorities for phasor applications, projects when each application will reach production-grade, and reviews some of the factors and considerations that will affect whether these measures come to pass.

Table 5-1 indicates what the RAPIR team members believe are the relative priorities for phasor application development.

Table 5-1 — Phasor Data Applications Summary with Priorities

Application	Priority For Real-time Operators	Priority For Day-ahead Operations	Assent Management and Utilization	Comments
	Real-time operations		Planning	
Alarming and setting System Operating Limits; Event detection and avoidance	<i>High</i>	<i>Low</i>	<i>Low</i>	Relies on baselining work
Baselining	<i>High</i>	<i>High</i>	<i>High</i>	
Dynamic line ratings and congestion management	<i>Medium</i>	<i>High</i>	<i>Medium</i>	
Fault location	<i>Medium</i>	<i>Low</i>	<i>Low</i>	
Power oscillations	<i>High</i>	<i>Medium</i>	<i>Medium</i>	
Frequency stability	<i>Medium</i>	<i>Low</i>	<i>Medium</i>	May become a higher priority with large-scale wind integration
Operations planning	<i>Low</i>	<i>High</i>	<i>Medium</i>	
Outage restoration	<i>High</i>	<i>Low</i>	<i>Low</i>	
Resource integration	<i>Medium</i>	<i>Low</i>	<i>High</i>	
Special protection schemes and islanding	<i>Low</i>	<i>Medium</i>	<i>High</i>	

State estimation	<i>Medium</i>	<i>Low</i>	<i>Low</i>	
Voltage monitoring and trending	<i>High</i>	<i>Low</i>	<i>Low</i>	
Wide-area controls	<i>Low</i>	<i>Low</i>	<i>High</i>	
Wide-area situational awareness	<i>High</i>	<i>Medium</i>	<i>Low</i>	
Forensic Analysis	<i>Medium</i>	<i>Medium</i>	<i>High</i>	
Generator Model Validation	<i>Low</i>	<i>High</i>	<i>High</i>	
Load Model Derivation	<i>Low</i>	<i>High</i>	<i>High</i>	
System Model Validation	<i>Low</i>	<i>High</i>	<i>High</i>	

5.2 What's Production-Grade Today?

When will various phasor equipment, systems and applications be ready for integration into real-time grid operation and controls? What phasor applications are ready for full use today? The immediate value realized from phasor data is the ability to perform system performance assessments and post-event analysis using time-synchronized information from disparate geographic sources. In turn this analysis will help the industry begin to develop event profiles that can be used to further application development for real-time operations use. When we know what to look for based on past events, we can develop the tools (such as specialized alarming) needed to alert operators when adverse grid conditions appear.

5.3 Recommendations and the Path Forward

The synchrophasor technology Smart Grid Investment Grant projects now under way will move the industry much closer to understanding production-grade synchrophasor system requirements and building production-quality phasor data applications. Table 5-2 offers the RAPIR Task Force members' collective hypotheses on when various phasor data applications may become production-grade

Table 5-2 — Phasor Applications Timeline

Application	Estimated Availability Timeframe	Assumed Functionality When Production Ready
Phasor data use for real-time operations		
Alarming and setting SOLs; Event detection and avoidance	2013	<ul style="list-style-type: none"> • Review of data to determine normal range of operation • Monitoring with alerts to indicate operation outside identified normal conditions • Presentation and decision support tools available to help identify problem and react in a timely manner
Dynamic line ratings and congestion management	2018	<ul style="list-style-type: none"> • Real-time calculation of line ratings with feed through to online monitoring tools (network applications and SCADA)
Fault location	2018	<ul style="list-style-type: none"> • Geo-spatial display of event location along with confidence level for location • Near real-time presentation with history capability so events can be displayed for review • Event type identification and display (phase-ground v. phase-phase fault, loss of load, loss of generation, etc.)
Power oscillations	2015	<ul style="list-style-type: none"> • Oscillation detection and mode meter • Display estimates of oscillation damping from ambient damping • Display oscillation energy • Decision support tools to deal with poorly dampened oscillations
Frequency stability	2013	<ul style="list-style-type: none"> • Track system frequency • Detect generation and load loss events
Outage restoration	2013	<ul style="list-style-type: none"> • Assist in re-synchronizing of islands • Quicker restoration by facilitating quicker forensics and event identifications
Resource integration	2015	<ul style="list-style-type: none"> • Dynamic issues identified through the use of historical data • Tools to help identify issues related to resource specific behavior in selected regions
Special protection schemes and islanding	2018	<ul style="list-style-type: none"> • Adequately identify pre-cursors to events that would trigger the need for islanding and allow for manual or planned separation. • Insure proper generation controls in place to manage the island once created
State estimation	2013	<ul style="list-style-type: none"> • Integrate phasor data and phase angle measurements in state estimators
Voltage monitoring and trending	2015	<ul style="list-style-type: none"> • Voltage stability indicators defined with relation to current operating point • Long and short term trending to help identify changes in system conditions and/or comparison

		of different time snapshots
Wide-area controls	2015 2020	<ul style="list-style-type: none"> • Response-based wide-area reactive switching when wide-area voltage instability is detected • Response-based inter-area oscillation damping using power modulation controls (centralized or distributed) to dampen inter-area power oscillations
Wide-area situational awareness	2013	<p>Trending displays</p> <ul style="list-style-type: none"> • Display trends of system frequency at multiple locations (long and short time frame) • Display trends of major path flows • Training on what various disturbances may look like <p>Phase angle alarms and displays</p> <ul style="list-style-type: none"> • Displays that show angular separation between critical areas in the system • Phase angle alarms • Decision support tools to deal with alarms • Reactive reserve monitors • Training for operators on what to do with this information
Phasor data use for planning (off-line applications)		
Baselining	2013	<p>Baselining tools</p> <ul style="list-style-type: none"> • Integrate system performance indicators (damping, voltage stability, etc) into EMS • Use baselines to improve planning models • Provide seasonal reports • Begin using baselines for pattern recognition and early diagnosis of non-normal grid events • Begin using baselines to set alert and alarming thresholds
Alarming and SOL evaluation and design	2015	<ul style="list-style-type: none"> • Wide area phasor angles may be better indicators of limiting conditions and SOLs • Alarms and SOLs based on system damping
Forensic event analysis	2013	<ul style="list-style-type: none"> • Mechanisms in place for collecting data from internal PMUs as well as external units with supporting data • Tools to identify significant operational parameters involved (modes of oscillation, frequency excursions, voltage impacts, etc...)
Generator model validation	2013	<p>Power plant model and performance validation</p> <ul style="list-style-type: none"> • validate power plant models • track power plant performance with respect to voltage, frequency and oscillations, alarm if performance change is observed • Detect control failures
Load model derivation	2015	<ul style="list-style-type: none"> • Estimate system load sensitivity to frequency • Estimate real-time load sensitivity to voltages • Measure and analyze dynamic load response during FIDVR events
Power oscillations	2015	<ul style="list-style-type: none"> • Oscillation detection and mode meter

		<ul style="list-style-type: none"> • Baseline oscillation damping with respect to system operating conditions
Frequency stability	2015	<ul style="list-style-type: none"> • Analysis and baselining of system frequency performance • Analysis and baselining of governor response distribution in an interconnection
Oscillation and stability analysis	2015	<ul style="list-style-type: none"> • Oscillation detection and mode meter • Display estimates of oscillation damping from ambient damping • Display oscillation energy • Early decision support tools to deal with poorly dampened oscillations
SPS and islanding design	2018	<ul style="list-style-type: none"> • Adequately identify pre-cursors to events that would trigger the need for islanding and allow for manual or planned separation. • Insure proper generation controls in place to manage the island once created.
System model calibration and validation	2013	<ul style="list-style-type: none"> • Adopt processes for system model validation using tools to compare actual event data to study results

5.3.1 Hardware and software needs

Phasor technology hardware is mature. There are two principal hardware challenges today. The first is how to build PMUs that can perform effectively and consistently at sampling rates of 120 samples per second, to meet oscillation monitoring needs. The second is how to build and maintain a secure, dedicated communications system dedicated to phasor data that can deliver data and control directives fast enough to support interconnection-wide monitoring, analysis and automated controls. It is unlikely that either of these challenges will be met cost-effectively within the next five years.

5.3.2 Research

The most pressing research need is for baselining analyses, since good baselining feeds a wealth of other real-time and planning priorities including event diagnosis, alarm-setting, SOL setting, smarter real-time trending, validation of dynamic power system and power plant models, and development of intelligent operator decision support tools. Baselining in turn will require that the industry commit to solving the phasor data-sharing problem, which has been a stumbling block to research for years.

5.3.3 Learning from the ARRA SGIG and demonstration grants

As discussed at the start of this report, significant new synchrophasor systems are being installed across three North American interconnections, with system designs and installations beginning in 2010. These projects have ambitious scopes with respect to PMU deployment and communications systems across broad geographic and power system areas, and ambitious goals with respect to testing and proving a variety of power system reliability, operations and market applications. It will take at least a year until most of these systems have initial deployments in place, and three years or longer before their concepts have been fully tested and validated.

Since most of these phasor projects seek to end up with production-grade technology (albeit using customized rather than off-the-shelf technology) that is fully integrated into system operations, it is essential that the industry learn from these projects to expedite the realization of production-quality real-time phasor-based tools. While the SGIG awardees are communicating directly on issues of common interest, NASPI is working with the Department of Energy and the awardees to create opportunities for information-sharing about project specifications and applications. As the projects advance, NASPI will continue working with DOE and the awarded teams to identify common issues, effective designs and practices, and other measures that will strengthen phasor technology effectiveness and use.

5.3.4 Technology standards, performance and interoperability testing

With the NIST-coordinated effort to expedite the updating and harmonization of synchrophasor and substation communications protocols and time-synchronization technical standards, there should be more clarity around applicable technical standards for phasor technology by 2012. NASPI's Performance & Standards Task Team members are working on the IEEE and IEC standards harmonization effort, and also working to develop white papers and guidance on topics such as PMU and PDC technical specifications, that may eventually be codified into formal technical standards.

The Smart Grid Investment Grant project asset owners and managers are making major investments in phasor technology today without the benefit of such standards. The technical specifications they impose upon vendors and the practices and protocols they develop to ensure that their projects can collect and exchange high-quality phasor data within and among asset owners and users will effectively dictate the path for phasor technology interoperability going forward. Within three years, it should be clear what worked, what didn't work, and what needs to be fixed from these SGIG projects. Within five years, with updated technical standards in place, the industry should have developed formal test protocols and certification for a variety of synchrophasor equipment and applications. This will ensure that there is credibility in and comparability between vendors' claims, and facilitate interoperability between synchrophasor technology devices, applications, and projects.

To the degree that technical matters such as performance requirements, communications formats, time synchronization protocols and testing protocols become adopted as technical standards by standards development organizations, there will be less need for NERC to address these issues in prescriptive detail in future reliability standards.

5.3.5 Security

Physical and cyber-security requirements for synchrophasor systems will depend, for the foreseeable future, on how the NERC Critical Infrastructure Protection standards are written, the degree to which the asset owner recognizes its use of synchrophasor data to be for mission-critical purposes, and whether the synchrophasor system's elements are collocated with other critical assets (such as a substation, control room or communications network). Although there are no clear rules or cyber-security guidance today, NASPI and NERC recommend that synchrophasor projects be designed to accommodate the expectation that higher security requirements will be imposed in the future. The Department of Energy's Smart Grid Implementation Grant awards imposed extensive cyber-security requirements on the winning projects,²⁶ and may raise the bar for all phasor technology implementations going forward.

5.3.6 Putting phasor technology into NERC operating and planning standards

Many bulk power system operators and asset owners adopt new technologies and develop high quality practices for grid operations using those technologies without waiting for the imposition of formal reliability standards. This is evidenced by the history of early development and adoption of reliability tools such as state estimation, contingency analysis and PMU deployment and applications development to date. But as the NERC Real-time Tool and Best Practices Task Force recognized, and as the U.S.-Canada Blackout Investigation Task Force recognized before them, no technology or practice can be fully implemented to improve grid reliability until it is incorporated unambiguously into NERC reliability standards.

As the RTBPTF recognized in 2008, NERC's reliability rules contain few requirements for real-time reliability tools and practices; that has not changed as of 2010, and no current standards apply for synchrophasor-based real-time tools. The scope of reliability standards affecting real-time tools includes everything that might apply to SCADA, EMS systems, and communications networks. Eventually, NERC reliability standards to address real-time operational and planning tools could include both existing and future topics:

- PMU maintenance
- Critical Infrastructure Protection (CIP-002 through 009)
- Redundancy requirements for control systems
- Disturbance monitoring (PSC-002)
- Model validation (static and dynamic)
- Generator performance
- Wide-area situational awareness
- Unit measurements (PSC-24)
- Oscillatory behavior
- Control system maintenance
- System integration protection systems
- State estimation
- Communications system performance
- Communications system maintenance.

²⁶ See, for instance, DOE SGIG "Cyber Security Issues and Answers," November 19, 2009, at http://www.oe.energy.gov/DocumentsandMedia/200-300_Cyber-Security-J-Dagle.pdf.

Given the many ways that synchrophasor data and applications can be used to enhance grid reliability, the NERC Operating and Planning Committees should consider whether to develop some priority path for when and how to incorporate synchrophasor technology considerations into standards development and modification efforts.

The Critical Infrastructure Protection Committee should pay explicit attention to the growing role of synchrophasor data systems and what security measures are appropriate for different system elements and why. Additionally, phasor systems raise new questions about grid condition data and whether it should be considered as business- or security-confidential, or even as Critical Energy Infrastructure Information; it would be helpful if the CIPC conducts a deliberate conversation on these issues earlier, rather than later, in standards development and phasor system deployment.

5.3.7 NERC's role

NERC will continue to support the work of NASPI with financial support and staff participation, and seek to increase NERC stakeholder participation in setting NASPI research direction. In addition, NERC will continue to pilot new tools and components of synchrophasor data systems that have low technology risk. These pilots will largely produce open source systems to assure that NERC-funded technologies are available to the entire industry.

For 2010 and 2011, NERC has hired the non-profit Grid Protection Alliance (GPA) to produce or accelerate the development of several key synchrophasor system structural components:

- **openPDC and the openPDC Manager** – This work in 2010 largely completes the piloting of the second generation super-PDC system developed by TVA (with additional NERC funding). The openPDC is available to industry members at no cost, can be improved by users and developers, and can be incorporated into vendors' applications and software packages.
- **openPDC for operations** – The openPDC is available for transmission owners to use as a phasor data concentrator to support control room operations. The openPDC is also intended for reliability authorities to use as a super-PDC to support regional wide-area visualization, controls, and other real-time and planning functions. GPA will continue to support openPDC use and improvements, and work with vendors to facilitate its commercialization and use.
- **Regional openPDC hosts for storage** – NERC will be looking for at least four reliability authorities in the Eastern Interconnection to install and operate openPDCs in a network that provides a mechanism for redundant, long-term storage of phasor data.
- **PMU Registry** – Creates a common synchrophasor data system configuration service for use by applications and to support communications through services like NASPInet. The Registry assures that there will be common identifiers for all interconnected PMUs and PMU measurements.
- **PDC Test Bench** – A fast-paced effort in 2010 to develop a configurable appliance that can be used to evaluate PDCs (from substation to super-PDC). Having this tool in place for use by SGIG awardees should improve the quality of PDCs selected, provide insights on the performance of PDCs, and contribute to development of PDC performance specifications and testing. These will all improve future synchrophasor data system design.
- **openPG** – GPA will develop a rudimentary open-source Phasor Gateway (openPG), consistent with NASPInet architecture, to serve as an interface for super-PDC to super-

PDC communications among reliability coordinators in 2011. NERC will be working with Regional Node Hosts in the East to implement and test the openPG. This will allow the architectural element of phasor gateways to be functionally implemented as a pilot before the full NASPInet architecture is implemented, and facilitate phasor data-sharing and applications interoperability in the Eastern Interconnection.

NERC will be looking to vendors and NERC stakeholders to develop, and operate and maintain mainstream synchrophasor data systems and develop and improve desired phasor data applications.

5.4 What else is needed for phasor technology to succeed?

As with all new technologies, extensive end user training will be needed to successfully transition phasor technology into full use as a real-time operational tool. Operations personnel need to see how phasor data and applications can improve their ability to reliably operate the system. Applications and interfaces must be developed that make terabytes of data easy to visualize and interpret, including measures such as phasor-informed alerts and alarms, so that when operators need to deal with an emerging grid situation they can access tools to use the data constructively, or receive intelligent decision support options based on phasor system-enabled options.

If phasor technology lives up to its current promise, its long-term success may rest upon how it is institutionalized and funded. To date, phasor technology development and investment have come primarily from a few large early adopter transmission owners and grid operators, and from DOE and California R&D funding. NERC has supported these efforts in principle for years, and made a financial commitment to phasor technology by investing in NASPI project management and funding the development and deployment of the next generation super-PDC and the PMU Registry. Over the long-term, however, NERC believes that its role is to incubate reliability tools such as these, not to support and operate them forever. NERC expects to work with the industry and DOE to build on past and SGIG phasor technology investments to ensure that the industry finds and exploits the great value in these tools. Over time, NERC expects that the industry will develop applications and business models that allow phasor technology and tools to become accepted and valued as integrated reliability tools that no longer require long-term NERC or federal funding.

Synchrophasor technology today stands on the edge of realizing its full value for improving reliable grid operations. In 2010 we do not yet have enough PMUs deployed across the interconnections, enough robust communications networks delivering good phasor data into wide-area monitoring and visualization systems, enough high quality data shared for solid research and analysis, or enough robust phasor data applications in trusted use on operators' desks. But in three to five years, with the surge in investments in new phasor data systems and applications, all this will have changed, and phasor technology should be proving out its promise to transform and improve grid reliability.